



INDIGO

LIGHTING

LIGHTING
INNOVATION

CATALOGUE 2026



INDIGO
LIGHTING

Parc Artisanal de Cornemont
Rue de la Légende 32G
4141 Sprimont, Belgique

 +32 (0) 4 351 91 40

 info@indigo-lighting.com

 indigo-lighting.com

Publié en décembre 2025



INDIGO

LIGHTING



LUMINAIRES INTÉRIEURS

COLLERETTES	22
SPOTS	32
SEMI-ENCASTRÉS	86
DOWNLIGHTS	106
DALLES LED	128
ENCASTRÉS MURAUX	138
APPLIQUES	146
PLAFONNIERS	180
SUSPENSIONS	224
RAILS & PROJECTEURS	256
LIGNES CONTINUES	320
HUBLOTS	330
RÉGLETTES ÉTANCHES	342
HIGH BAY	348



LUMINAIRES EXTÉRIEURS

ENCASTRÉS DE SOL	362
SPOTS SUR PIQUET	384
BORNES	404
ENCASTRÉS MURAUX	424
APPLIQUES	428
PLAFONNIERS	464
PROJECTEURS	476
SPOTS	494
SOLAIRES	500



INDIGO

LIGHTING

ACCESSOIRES

















SOURCES, DOUILLES ET CÂBLES	504
ALIMENTATIONS	510
GESTION D'ÉCLAIRAGE	516
BOÎTES DE RACCORDEMENT ET CONNECTEURS IP	520

PICTOGRAMMES	528
INDEX GÉNÉRAL	530

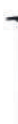
INTÉRIEUR

 NEW ELENA L RDH 50	 NEW ELENA L RDX 51	 NEW ELENA M RDH 48	 NEW ELENA M RDX 49	 NEW ELENA S RDH 47	 NEW ELENA XL RDH 52	 NEW ELENA XL RDX 53	 NEW KAHA RDH 54
 NEW OLYN 1 RDX 98	 NEW OLYN 2 RDX 99	 NEW OBIA 1 RX 102	 NEW OBIA 2 RX 102	 NEW TIGA 1 RD EVO 110	 NEW TIGA 2 RD EVO 110	 NEW TIGA 3 RD EVO 111	
 NEW JUPI 150	 NEW JUPI S19 150	 NEW RONDY 1 W 152	 NEW RONDY 2 W 152	 NEW DIPLO 1 154	 NEW DIPLO 2 154	 NEW LIVRO GU10 156	 NEW LUSY R 157
 NEW OLYN 2 C 204	 NEW DROPY P 238	 NEW NARIA 1 P 250	 NEW NARIA 2 P 251	 NEW NARIA 3 P 252	 NEW OBIA 1 P 234	 NEW OBIA 2 P 234	 NEW OLYN 1 P 228
 NEW LIDY SENSOR IR 337	 NEW MINI TIMY EVO 333	 NEW MINI TIMY SENSOR EVO 333	 NEW TIMY EVO 334	 NEW TIMY SENSOR EVO 334			

EXTÉRIEUR

 NEW GL016 II 372	 NEW GL016 F II 373	 NEW GL019 II 366	 NEW GL019 F II 367	 NEW GL019 LG II 368	 NEW GL019 ULG II 369	 NEW GL038 II 376	 NEW GL040 II 374
 NEW BARKO 438	 NEW FLORIA 1 398	 NEW FLORIA 2 399	 NEW FLORIA 3 400	 NEW FLORIA 4 401	 NEW RUBYX R 458	 NEW RUBYX S 458	 NEW SL220 MAINS II 402

ACCESSOIRES

 NEW CD191 512	 NEW CD187 514	 NEW 5672 514	 NEW 5675 514	 NEW 5677 514	 NEW 5678 514	 NEW 5742 514	 NEW 5744 514
 NEW 5988 514	 NEW 5989 514	 NEW 5993 514	 NEW 5996 514	 NEW 5997 514			

NOUVEAUTÉS

5672	514	INDYK3CSP	488
5675	514	INDY K3 CSP A	488
5677	514	JUPI	150
5678	514	JUPIS19	150
5742	514	KAHA RDH	54
5744	514	KAHA RDX	55
5783	514	LIDY SENSOR IR	337
5784	514	LIVRO GU10	156
5796	514	LUSY R	157
5802/T	515	LUSY S	157
5947	514	MINI TIMY EVO	333
5988	514	MINI TIMY SENSOR EVO	333
5989	514	MODUS EVO 1	66
5993	514	MODUS EVO 2	67
5996	514	NARIA 1 P	250
5997	514	NARIA 2 P	251
BARKO	438	NARIA 3 P	252
CAIMAN TUBULAR	345	OBIA 1 C	196
CD187	514	OBIA 1 P	234
CD191	512	OBIA 1 RX	102
DIPLO 1	154	OBIA 2 C	196
DIPLO 2	154	OBIA 2 P	234
DROPY P	238	OBIA 2 RX	102
ELENA L RDH	50	OLYN 1 P	228
ELENA L RDX	51	OLYN 1 RDX	98
ELENA M RDH	48	OLYN 1 W	168
ELENA M RDX	49	OLYN 2 C	204
ELENA S RDH	47	OLYN 2 P	229
ELENA XL RDH	52	OLYN 2 RDX	99
ELENA XL RDX	53	OLYN 3 T	280
FLORIA 1	398	RONDY 1 P	232
FLORIA 2	399	RONDY 2 P	232
FLORIA 3	400	RONDY 1 W	152
FLORIA 4	401	RONDY 2 W	152
GENBAY 1	354	RUBYX R	458
GENBAY 2	354	RUBYX S	458
GENBAY 3	355	SAMY RD	75
GL016 II	372	SL220 MAINS II	402
GL016 F II	373	SOLIS 1	130
GL019 II	366	SOLIS LENS	135
GL019 F II	367	SOLYA	162
GL019 LG II	368	TIGA 1 RD EVO	110
GL019 ULG II	369	TIGA 2 RD EVO	110
GL038 II	376	TIGA 3 RD EVO	111
GL040 II	374	TIMY EVO	334
GL040 ULG II	375	TIMY SENSOR EVO	334
GL100 II	382		



NEW
KAHA RDX
55



NEW
MODUS EVO 1
66



NEW
MODUS EVO 2
67



NEW
SAMY RD
75



NEW
SOLIS 1
130



NEW
SOLIS LENS
135



NEW
LUSY S
157



NEW
SOLYA
162



NEW
OLYN 1 W
168



NEW
OBIA 1 C
196



NEW
OBIA 2 C
196



NEW
OLYN 2 P
229



NEW
RONDY 1 P
232



NEW
RONDY 2 P
232



NEW
OLYN 3 T
280



NEW
GENBAY 1
354



NEW
GENBAY 2
354



NEW
GENBAY 3
355



NEW
CAIMAN TUBULAR
345



NEW
GL040 ULG II
375



NEW
GL100 II
382



NEW
INDY K3 CSP
488



NEW
INDY K3 CSP A
488



NEW
5783
514



NEW
5784
514



NEW
5796
514



NEW
5802/T
515



NEW
5947
514

COLLERETTES



ALA1013 RX GU10
AUTO
26



ALA1013 SX GU10
AUTO
27



BALI R GU10
28



COMO RX GU10
29



FIJI R GU10
28



HD1050 R GU10
30



HD1070 R GU5.3
30



KASA R GU10
24

SPOTS



ABY 1 RD
82



ABY 2 RD
82



ABY 3 RD
83



AL1014 RDX
68



AL1014 RX
68



AL1015 RX
69



AL2014 SDX
69



AL3012 RD
79



BORA RDH EVO
60



BORA RDX EVO
58



BORA SD EVO
57



BORA SDX EVO
59



BRAVA RD-230
42



BRAVA RDH-230
42



COPE RD
72



DEBI RD
44



NEW
ELENA S RDH
47



NEW
ELENA XL RDH
52



NEW
ELENA XL RDX
53



EPI RD
72



IENA RDX
44



IPHO 82 RD
70



IPHO 82 SD
70



NEW
KAHA RDX
55



LISY RDX
38



MARY RDX-230
45



NEW
MODUS EVO 1
66



NEW
MODUS EVO 2
67



MOWI RD
39



SILK RDX
78



SPOTI R-B
35



NEW
SAMY RD
75

SEMI-ENCASTRÉS



ALLY 1 RDX
94



ALLY 2 RDX
94



CLIC RDX
96



CLIC RDX MINI
96



FILI 1 RX GU10 AUTO
90



FILI 1 RX-B
92



FILI 5 RDX-B
92



FILI 5 RX-B GU10 AUTO
90



NEW
OLYN 2 RDX
99



RETI 1 RX
104



RETI 2 RX
104



SIRA R
88



SIRA R SENSOR IR
88

DOWNLIGHTS



AL1016 RX
115



DAX RD-230
108



FOCEA 1 SX PLUS
126



FOCEA 2 SX
126



FOX 2 RD
114



IZA 1 SDX
122



IZA 2 SDX
122



LYON 1 R
118



SPIRA 3 RX
125



THEA LITE CSP 1
112



THEA LITE CSP 2
113



THEA LITE CSP 3
113



THEA PRO 1
116



THEA PRO 2
117



TIGA 1 RD EVO
110



TIGA 2 RD EVO
110

COLLERETTES



KASA RX GU10
24

ALA1013 RX GU10 AUTO	26	HD1050 R GU10	30
ALA1013 SX GU10 AUTO	27	HD1070 R GU5.3	30
BALI R GU10	28	KASA R GU10	24
COMO RX GU10	29	KASA RX GU10	24
FIJI R GU10	28		

SPOTS



AL3012 RD WARM
79



ALEX RDX
62



ALLY 3 RDX
84



ALLY 4 RDX
84



BORA RD EVO
56



DOTS
85



NEW
ELENA L RDH
50



NEW
ELENA L RDX
51



NEW
ELENA M RDH
48



NEW
ELENA M RDX
49



KALI R-230 B
36



KORY R
64



KORY R SENSOR
64



LASY RX
34



LISY RD
38



SWEET RD EVO
76



SYLA RD-B
80



TIBLI R-B
34



TIPI RX
40



TIPI RX
40

ABY 1 RD	82	IENA RDX	44
ABY 2 RD	82	IPHO 82 RD	70
ABY 3 RD	83	IPHO 82 SD	70
AL1014 RDX	68	KACI R-B	37
AL1014 RX	68	KAHA RDH	54
AL1015 RX	69	KAHA RDX	55
AL2014 SDX	69	KALIR-230B	36
AL3012 RD	79	KORYR	64
AL3012 RD WARM	79	KORY R SENSOR	64
ALEX RDX	62	LASY RX	34
ALLY 3 RDX	84	LISY RD	38
ALLY 4 RDX	84	LISY RDX	38
BORA RD EVO	56	MARY RDX-230	45
BORA RDH EVO	60	MODUS EVO 1	66
BORARDX EVO	58	MODUS EVO 2	67
BORA SD EVO	57	MOWI RD	39
BORA SDX EVO	59	SAMY RD	75
BRAVA RD-230	42	SILK RDX	78
BRAVA RDH-230	42	SPOTI R-B	35
COPE RD	72	SWEET RD EVO	76
DEBI RD	44	SYLA RD-B	80
DOTS	85	TIBLI R-B	34
ELENA L RDH	50	TIPI RX	40
ELENA L RDX	51	TIPI SX	40
ELENA M RDH	48		
ELENAM RDX	49		
ELENA S RDH	47		
ELENA XL RDH	52		
ELENA XL RDX	53		
EPI RD	72		

SEMI-ENCASTRÉS



KARL 1 RDX
100



KARL 2 RDX
100



NEW
OBIA 1 RX
102



NEW
OBIA 2 RX
102



NEW
OLYN 1 RDX
98

ALLY 1 RDX	94	OBIA 1 RX	102
ALLY 2 RDX	94	OBIA 2 RX	102
CLIC RDX	96	OLYN 1 RDX	98
CLIC RDX MINI	96	OLYN 2 RDX	99
FILI 1 RX GU10 AUTO	90		
FILI 1 RX-B	92	RETI 1 RX	104
FILI 5 RDX-B	92	RETI 2 RX	104
FILI 5 RX-B GU10 AUTO	90	SIRA R	88
KARL 1 RDX	100	SIRA R SENSOR IR	88
KARL 2 RDX	100		

DOWNLIGHTS



LYON 2 R
119



LYON 3 R
120



LYON 4 R
121



SENSO R-230
108



SPIRA 1 RX PLUS
124



TIGA 3 RD EVO
111

AL1016 RX	115	SPIRA 3 RX	125
DAX RD-230	108	THEA LITE CSP 1	112
FOCEA 1 SX PLUS	126	THEA LITE CSP 2	113
FOCEA 2 SX	126	THEA LITE CSP 3	113
FOX 2 RD	114	THEA PRO 1	116
IZA 1 SDX	122	THEA PRO 2	117
IZA 2 SDX	122	TIGA 1 RD EVO	110
LYON 1 R	118	TIGA 2 RD EVO	110
LYON 2 R	119	TIGA 3 RD EVO	111
LYON 3 R	120		
LYON 4 R	121		
SENSO R-230	108		
SPIRA 1 RX PLUS	124		

DALLES LED



DOMINO
136



DOMINO CSP
137



NEW
SOLIS 1
130



SOLIS 2
132



SOLIS 3
133



SOLIS IP65
131

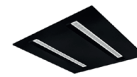

NEW
SOLIS LENS
135

ENCASTRÉS MURAUX



EVA 65R
140



EVA 65S
140



LIKA
142



MAKA
143



STEPBEAM
144

APPLIQUES



AUREA 3 W
158



AUREA 4 W
159



BIXBY
165



NEW
DIPLO 1
154



NEW
DIPLO 2
154



EVIA G9
148



FOLD 1
167



FOLD 2
167



KAVA
172



NEW
LIVRO GU10
156



LONGA
177



NEW
LUSY R
157



NEW
LUSY S
157



MALTA 1
176



MALTA 2
176



MILO 1
160



PLANK 1
179



PLANK 2
179



RETI W
170



NEW
RONDY 1 W
152



NEW
RONDY 2 W
152



SNOOP GU10
149



SNOOP
149



NEW
SOLYA
162

PLAFONNIERS



ALBA R GU10
182



ALBA S GU10
182



AUREA 1 C
202



AUREA 2 C
203



CAPRI R 1 C
216



CAPRI R 2 C
217



CAPRI R 3 C
218



CAPRI S 1 C
219



EVA 62 R
195



HAPPY 1
198



HAPPY 2
199



HAPPY 3
200



HULA C
212



JUNE 1 C
214



JUNE 2 C
214



JUNE 3 C
215



NOVA CSP 1 C
220



NOVA CSP 2 C
220



NOVA CSP 3 C
221



NEW
OBIA 1 C
196



NEW
OBIA 2 C
196



PIXA 3
209



RIVA 2 GU10
193



RIVA 3 GU10
193



RIVA 4 GU10
194



TIPO 1 C
210



TIPO 2 C
210



TOMY 1 C
223



YUKO GU10
187

DALLES LED

DOMINO	136	SOLIS 3	133
DOMINO CSP	137	SOLIS IP65	131
SOLIS 1	130	SOLIS LENS	135
SOLIS 2	132		

ENCASTRÉS MURAUX

EVA 65R	140	MAKA	143
EVA 65S	140	STEPBEAM	144
LIKA	142		

APPLIQUES

AUREA 3 W	158	MALTA 1	176
AUREA 4 W	159	MALTA 2	176
BIXBY	165	MILO 1	160
DIPLO 1	154	MILO 2	160
DIPLO 2	154	MILO 3	161
EVIA G9	148	MILO 4	161
FOLD 1	167		
FOLD 2	167	OLYN 1 W	168
FULLA	173	PLANK 1	179
GLAM 250	175	PLANK 2	179
GLAM 90	174	RETI W	170
JUPI	150	RONDY 1 W	152
JUPI S19	150	RONDY 2 W	152
KAVA	172	SNOOP	149
LIVRO GU10	156	SNOOP GU10	149
LONGA	177	SOLYA	162
LUSY R	157	VITEL GX53	148
LUSY S	157		



PLAFONNIERS

ALBA R GU10	182	NOLY GU10	186
ALBA S GU10	182	NOVA CSP 1 C	220
AUREA 1 C	202	NOVA CSP 2 C	220
AUREA 2 C	203	NOVA CSP 3 C	221
CAPRI R 1 C	216	OBIA 1 C	196
CAPRI R 2 C	217	OBIA 2 C	196
CAPRI R 3 C	218		204
CAPRI S 1 C	219	PIXA 1	208
CAPRI S 2 C	219	PIXA 2	208
CLAC	207	PIXA 3	209
CLAC 1 MINI	206	RIVA 2 GU10	193
CLAC 2 MINI	206	RIVA 3 GU10	193
DOTS C	222	RIVA 4 GU10	194
EVA 62 R	195	TIPO 1 C	210
HAPPY 1	198	TIPO 2 C	210
HAPPY 2	199	TOMY 1 C	223
HAPPY 3	200	YUKO GU10	187
HULA C	212		
JUNE 1 C	214		
JUNE 2 C	214		
JUNE 3 C	215		
LUPO 1 GU10	184		
MANYL 2	185		
MANYL 2 GU10	185		
MOLY GU10	186		

SUSPENSIONS



1 ALLUMAGE

3 ALLUMAGES

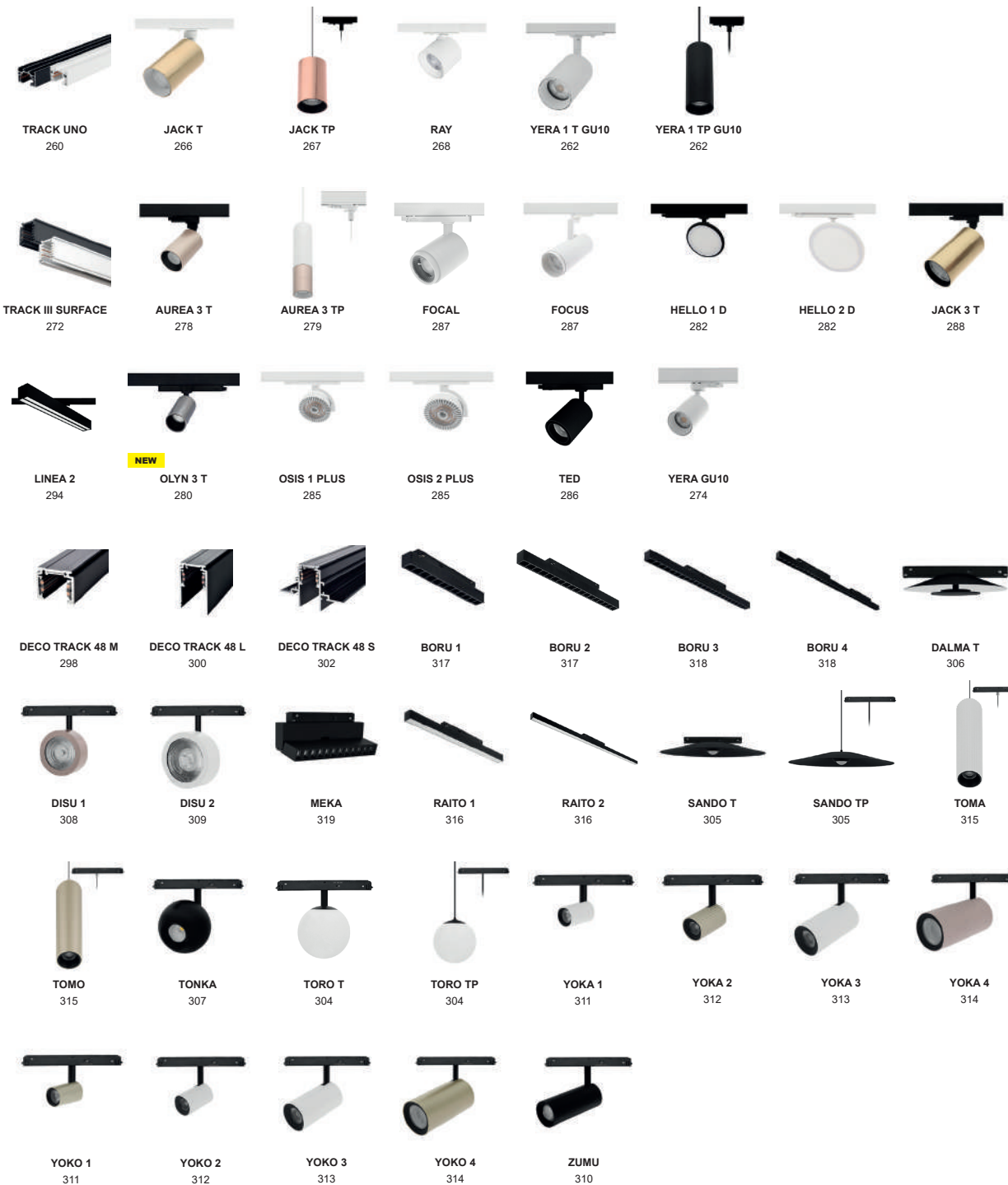

RAILS & PROJECTEURS

ARCHITECTURAUX

DECO TRACK 48

SUSPENSIONS



AUREA P	227	NARIA 2 P	251
CAPRI R 1 P	244	NARIA 3 P	252
CAPRI R 2 P	244	NOVA CSP 1 P	248
CAPRI R 3 P	245	NOVA CSP 2 P	248
CAPRI S 1 P	246	NOVA CSP 3 P	249
CAPRI S 2 P	246	OBIA 1 P	234
DROPY P	238	OBIA 2 P	234
HELLO 1 P	239	OLYN 1 P	228
HELLO 2 P	239	OLYN 2 P	229
HUBA P	240	RETI P	236
HULA P	241	RONDY 1 P	232
JACK 3 P	230	RONDY 2 P	232
JUNE 1 P	242	TOMY 1 P	254
JUNE 2 P	242	TOMY 2 P	254
JUNE 3 P	243		
NARIA 1 P	250		

RAILS & PROJECTEURS

1 ALLUMAGE

JACK T	266	RAY	268
JACK TP	267	TRACK UNO	260
		YERA 1 T GU10	262
		YERA 1 TP GU10	262

3 ALLUMAGES

AUREA 3 T	278	LINEA 1	294
AUREA 3 TP	279	LINEA 2	294
FOCAL	287	OLYN 3 T	280
FOCUS	287	OSIS 1 PLUS	285
HELLO 1 D	282	OSIS 2 PLUS	285
HELLO 2 D	282	TED	286
JACK 3 T	288	TRACK III SURFACE	272
JACK 3 TP	290	YERA GU10	274
LIMA 1 PLUS	291		
LIMA 2 PLUS	292		
LIMA 3 PLUS	293		

ARCHITECTURAUX

DECO TRACK 48

BORU 1	317	TOMA	315
BORU 2	317	TOMO	315
BORU 3	318	TONKA	307
BORU 4	318	TORO T	304
DALMAT	306	TOROTP	304
DECO TRACK 48 L	300	YOKA 1	311
DECO TRACK 48 M	298	YOKA 2	312
DECO TRACK 48 S	302	YOKA 3	313
DISU 1	308	YOKA 4	314
DISU 2	309	YOKO 1	311
MEKA	319	YOKO 2	312
RAITO 1	316	YOKO 3	313
RAITO 2	316	YOKO 4	314
SANDO T	305	ZUMU	310
SANDO TP	305		



LIGNES CONTINUES



LINEAR 1 C
324

LINEAR 1 P
326

LINEAR 2 C
325

LINEAR 2 P
328

HUBLOTS



LIDY
336

LIDY SENSOR
336

LIDY A
338

LIDY A SENSOR
338

NEW
LIDY SENSOR IR
337

MINI TIMY E27
332

NEW
MINI TIMY EVO
333

NEW
MINI TIMY SENSOR E27
332

RÉGETTES ÉTANCHES



CAIMAN QUICK CONNECT
346

NEW
CAIMAN TUBULAR
345

CAIMAN VERSA
346

POLAS VERSA
344

HIGH BAY



EAZY
359

NEW
GENBAY 1
354

NEW
GENBAY 2
354

NEW
GENBAY 3
355

SPRINGBOK LITE 1
356

SPRINGBOK LITE 2
356

SPRINGBOK LITE 3
357

ENCASTRÉS DE SOL



APA RD-230
377

BIG APA RD-230
377

NEW
GL016 II
372

NEW
GL016 F II
373

GL018 C
365

NEW
GL019 II
366

NEW
GL019 F II
367

NEW
GL019 LG II
368

GL200
383

GYRO
378

GYRO A
378

KO2000 R GU10
364

SWIM
370

TILT 1
379

TILT 2
380

TILT 3
380

SPOTS SUR PIQUETS

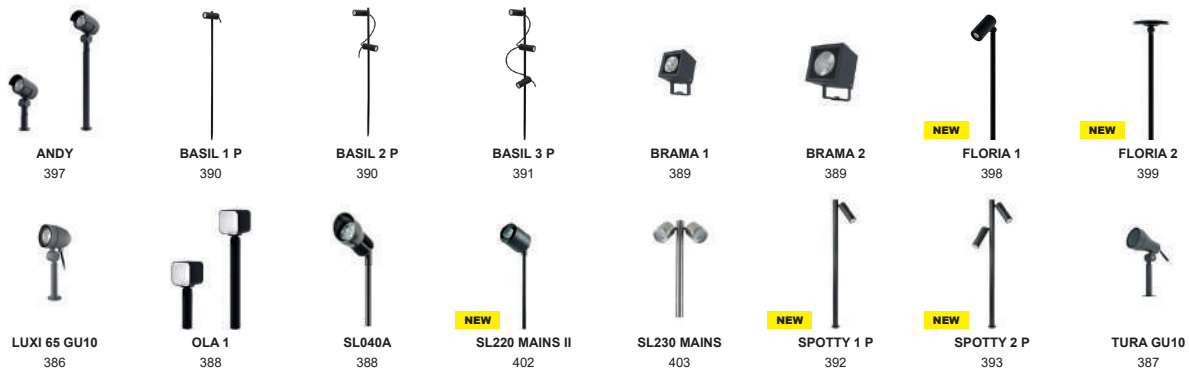

ANDY
397

BASIL 1 P
390

BASIL 2 P
390

BASIL 3 P
391

BRAMA 1
389

BRAMA 2
389

NEW
FLORIA 1
398

NEW
FLORIA 2
399

LUXI 65 GU10
386

OLA 1
388

SL040A
388

NEW
SL220 MAINS II
402

SL230 MAINS
403

NEW
SPOTTY 1 P
392

NEW
SPOTTY 2 P
393

TURA GU10
387

LIGNES CONTINUES

LINEAR 1 C	324	LINEAR 2 C	325
LINEAR 1 P	326	LINEAR 2 P	328

HUBLOTS

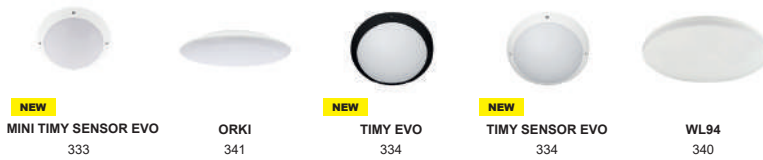

LIDY	336	MINI TIMY SENSOR E27	332
LIDY A	338	MINI TIMY SENSOR EVO	333
LIDY A SENSOR	338	ORKI	341
LIDY SENSOR	336	ORKI SENSOR	341
LIDY SENSOR IR	337	TIMY EVO	334
MINI TIMY E27	332	TIMY SENSOR EVO	334
MINI TIMY EVO	333	WL94	340

RÉGLETTES ÉTANCHES

CAIMAN QUICK CONNECT	346	CAIMAN VERSA	346
CAIMAN TUBULAR	345	POLAS VERSA	344

HIGH BAY

EAZY	359	SPRINGBOK LITE 1	356
GENBAY 1	354	SPRINGBOK LITE2	356
GENBAY 2	354	SPRINGBOK LITE3	357
GENBAY 3	355		

ENCASTRÉS DE SOL



APA RD-230	377	GL200	383
BIG APA RD-230	377	GYRO	378
GL016 II	372	GYRO A	378
GL016 F II	373	KO2000 R GU10	364
GL018 C	365	SWIM	370
GL019 F II	367	TILT 1	379
GL019 II	366	TILT 2	380
GL019 LG II	368	TILT 3	380
GL019 ULG II	369	TILT 4	381
GL038 II	376	TILT 5	381
GL040 II	374	WALLY A	371
GL040 ULG II	375		
GL100 II	382		

SPOTS SUR PIQUETS

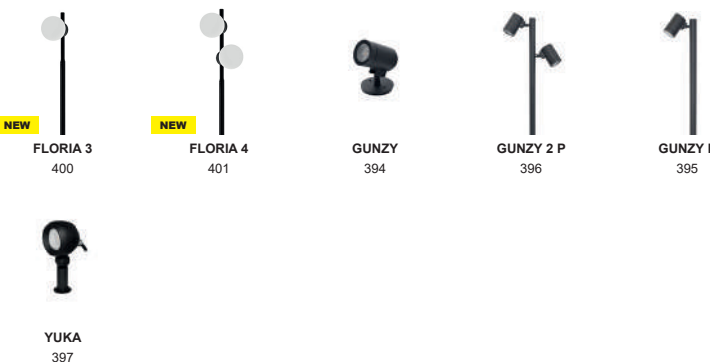

ANDY	397	GUNZY 2P	396
BASIL 1 P	390	GUNZY P	395
BASIL 2 P	390	LUXI 65 GU10	386
BASIL 3 P	391	OLA 1	388
BRAMA 1	389	SL040A	388
BRAMA 2	389	SL220 MAINS II	402
FLORIA 1	398	SL230 MAINS	403
FLORIA 2	399	SPOTTY 1 P	392
FLORIA 3	400	SPOTTY 2 P	393
FLORIA 4	401	TURA GU10	387
GUNZY	394	YUKA	397

BORNES



AMONT
412



AVI 1
421



AVI 2
421



BENS P
416



CYCLO
422



ELNE 1
408



ELNE 2
408



ELNE 4
408



LUXI 180
411



LUXI 54
410



LUXI 650
412



LUXI 80
418



MINO P E27
406



OLA 2
415



RAVEL
410



RONDO P E27
406

ENCASTRÉS
MURAUX



ARTSY
427



DEVI
426



PURE 190
426

APPLIQUES



ALMA R
450



ALMA S
450



ALTEA 1 GU10
430



ALTEA 2 GU10
430



ALTO 1 GU10
431



ALTO 2 GU10
431



ARCOLE
443



NEW
BARKO
438



CHERA
449



COSTE 1
436



COSTE 2
436



DANI
443



EDGY
447



ELBY S
435



FURY S GU10
432



GUNZY 2 S
441



KOPA
452



KOS 1 S
454



KOS 2 R
427



KOS 2 S
455



KUBO
453



LANTERN
447



LUXI 120 S
446



LUXI 139
446



LUXI 95
448



MINO W E27
433



NORA
456



POLO
463



RONDO W E27
433



NEW
RUBYX R
458



NEW
RUBYX S
458



NEW
SPOTTY 1 W
439

PLAFONNIERS



ASPI 1 SENSOR
PLUS
474



ASPI 2 SENSOR
PLUS
475



FARO 1
472



FARO 2
472



LEWIS
468



LUZ 1
471



LUZ 2
471



ROMY R GU10
466

PROJECTEURS



CURTIS PLUS
482



CURTIS SENSOR
PLUS
483



INDY 1
484



INDY A
484



INDY 2
487



INDY 2 A
487



RAYPRO 14
489



RAYPRO 32
490

BORNES



FILO P
419



FINN P
414



HYDRA
420



LUXI 100 S P
415



LUXI 175 SENSOR P
411



SETO
416



SLIM
417



STELLA
413



TULO E27
407



TULO SENSOR E27
407

AMONT	412	LUXI 180	411
AVI 1	421	LUXI 54	410
AVI 2	421	LUXI 650	412
BENS P	416	LUXI 80	418
CYCLO	422	MINO P E27	406
CYCLO SENSOR	422	OLA 2	415
ELNE 1	408	RAVEL	410
ELNE 2	408	RONDO P E27	406
ELNE 4	408	SETO	416
FILO P	419	SLIM	417
FINN P	414	STELLA	413
HYDRA	420	TULO E27	407
LUXI 100 S P	415	TULO SENSOR E27	407
LUXI 175 SENSOR P	411		

ENCASTRÉS MURAUX

ARTSY	427	PURE 190	426
DEVI	426		

APPLIQUES



BENS W
442



BRIKPRO 1
460



BRIKPRO 1 A
460



BRIKPRO 2
462



BRIKPRO 2 A
462



GUNZY S
441



HARRY A
457



HUGO GU10
432



ITO
437



KADRO E27
434



LUXI 175 SENSOR
445



LUXI 190
448



LUXI 290
448



LUXI 45
444



LUXI 45 SENSOR
444



NEW
SPOTTY 2 W
440



NEW
SPOTTY 3 W
440

ALMA R	450	KADRO E27	434
ALMA S	450	KOPA	452
ALTEA 1 GU10	430	KOS 1 S	454
ALTEA 2 GU10	430	KOS 2 R	454
ALTO 1 GU10	431	KOS 2 S	455
ALTO 2 GU10	431	KUBO	453
ARCOLE	443	LANTERN	447
BARKO	438	LUXI 120 S	446
BENS W	442	LUXI 139	446
BRIKPRO 1	460	LUXI 175 SENSOR	445
BRIKPRO 1 A	460	LUXI 190	448
BRIKPRO 2	462	LUXI 290	448
BRIKPRO 2 A	462	LUXI 45	444
CHERA	449	LUXI 45 SENSOR	444
COSTE 1	436	LUXI 95	448
COSTE 2	436	MINO W E27	433
DANI	443	NORA	456
EDGY	447	POLO	463
ELBY S	435	RONDO W E27	433
FURY S GU10	432	RUBYX R	458
GUNZY 2 S	441	RUBYX S	458
GUNZY S	441	SPOTTY 1 W	439
HARRY A	457	SPOTTY 2 W	440
HUGO GU10	432	SPOTTY 3 W	440
ITO	437		

PLAFONNIERS

ASPI 1 SENSOR PLUS	474	LUZ 2	471
ASPI 2 SENSOR PLUS	475	ROMY R GU10	466
FARO 1	472	ROMY S GU10	466
FARO 2	472	UNIS R	469
LEWIS	468	UNIS S	469
LUZ 1	471		

PROJECTEURS

CURTIS PLUS	482	INDY K3 CSP A	488
CURTIS SENSOR PLUS	483	RAYPRO 14	489
INDY 1	484	RAYPRO 32	490
INDY 1 A	484	RAYPRO 32 A	491
INDY 2	487	RAYPRO 50	492
INDY 2 A	487	RAYPRO 50 A	493
INDY K3 CSP	488		

SPOTS



ADA 1 RX
496



ADA 2 RX
496



AL3012 RD OUT
498



NEW
H2 PRO EXTREME
CSP
499

SOLAIRES



KALA
503



RAMA P
502



RAMA W
502

SOURCES, DOUILLES
ET CABLE



SUP 08 AUTO
508



WCR275BLACK
509

ALIMENTATIONS



CD155
512



CD170
512



PSIP3509W
512



PSIP35018W
512



PSIP70018W
512



PSIP70036W
512



DRV150700
512



NEW
DRV350700TD
512



CD116
513



CD122
513



CD123
513



CD124
513



CD126
513



CD140
513



PSDIM700
513



PSDAL700M
513



CD171
514



CD158
514

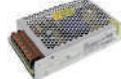

CD150
514

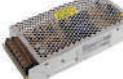

CD151
514



NEW
CD187
514



NEW
5744
514



NEW
5783
514



NEW
5784
514



NEW
5796
514



NEW
5947
514



NEW
5988
514



NEW
5989
514



NEW
5993
514

GESTION
D'ÉCLAIRAGE



CD135
518



CD136
518



LEDEP10
519

BOÎTES

BOÎTES DE RACCORDEMENT ET CONNECTEURS IP



JB1
522



JB2
523



JB4
523



JB5
524



JB6
524



JB7
525



WC59
522

SPOTS

ADA 1 RX	496	AL3012 RD OUT	498
ADA 2 RX	496	H2 PRO EXTREME CSP	499

SOLAIRES

KALA	503	RAMA W	502
RAMA P	502		

SOURCES ET DOUILLES

SUP 08 AUTO	508	WCR275BLACK	509
-------------------	-----	-------------------	-----

ALIMENTATIONS



5672	514	CD148	513
5675	514	CD150	514
5677	514	CD151	514
5678	514	CD153	515
5742	514	CD154	515
5744	514	CD155	512
5783	514	CD158	514
5784	514	CD170	512
5796	514	CD171	514
5802/T	515	CD187	514
5947	514	CD191	512
5988	514	DRV150700	512
5989	514	DRV350700TD	512
5993	514	PLDUNIDRIV350MA	513
5996	514	PLDUNIDRIVE700MA	513
5997	514	PSDAL350M	513
CD102	512	PSDAL700M	513
CD104	512	PSDIM350	513
CD112	512	PSDIM700	513
CD116	513	PSIP35018W	512
CD122	513	PSIP3509W	512
CD123	513	PSIP70018W	512
CD124	513	PSIP70036W	512
CD126	513		
CD140	513		
CD147	512		

GESTION D'ÉCLAIRAGE

CD135	518	LEDEP	519
CD136	518		

BOÎTES DE RACCORDEMENT
ET CONNECTEURS IP

JB1	522	JB6	524
JB2	523	JB7	525
JB4	523	WC 5-9	522
JB5	524		



LUMINAIRES INTÉRIEURS







COLLERETTES	22
SPOTS	32
SEMI-ENCASTRÉS	86
DOWNLIGHTS	106
DALLES LED	128
ENCASTRÉS MURAUX	138
APPLIQUES	146
PLAFONNIERS	180
SUSPENSIONS	224
RAILS & PROJECTEURS	256
LIGNES CONTINUES	320
HUBLOTS	330
RÉGLETTES ÉTANCHES	342
HIGH BAY	348



CLASSEMENT PAR DIAMÈTRES D'ENCASTREMENT

COLLETTES	PAGE 2026		DIMENSIONS (mm)	IP X		Watt Max	12 V	230 V	RE 2020
KASA R GU10	24	60	78	23		10W		V	
ALA1013 RX GU10 AUTO	26	68	82	23	30°	10W		V	
ALA1013 SX GU10 AUTO	27	68	82x82	23	30°	10W		V	
HD1050 R GU10	30	68	82	65		10W		V	V
HD1070 R GU5.3	30	68	82	65		10W	V	V	V
KASA RX GU10	24	75	82	23	30°	10W		V	
BALI R GU10	28	75	83	20		10W		V	
COMO RX GU10	29	83	90	20	25°	10W		V	
FIJI R GU10	28	85	90	20		10W		V	

SPOTS	PAGE 2026		DIMENSIONS (mm)	IP X		CCT	LED	UGR <19	LED 230V		LAMELLES		RE 2020
TIBLI R-B	34	25	30	20			1,2W	V		En option	V		
SPOTI R-B	35	35	40	44			4,5W	V			V	V	
ELENA S RDH	47	35	41	65		2700-3000-4000K	4W	V	V		V	V	V
DOTS	85	39x35	48x44	20			3W	V	V				
LASY RX	34	42	52	44	30°		1W					V	
ELENA M RDH	48	42	49,5	65		2700-3000-4000K	6W	V		V		V	V
LISY RD	38	45	55	23			4,5W			V			
MOWI RD	39	45	55	23			6W	V	V	V			
KALI R-230 B	36	55	72	20			4,7W		V		V	V	
KACI R-B	37	55	70	44			3W				V	V	
TIPI RX	40	55	64	44	30°		3W					V	
TIPI SX	40	55	64x64	44	30°		3W					V	
ELENA M RDX	49	55	62,5	65	20°	2700-3000-4000K	6W	V		V		V	V
LISY RDX	38	58	66	23	20°		4,5W			V			
KORY R	64	68	88	65		2700-3000-4000K	6W					V	V
KORY R SENSOR	64	68	88	65		2700-3000-4000K	6W					V	V
BRAVA RD-230	42	68	85	65		2700-3000-4000K	5W		V	V		V	V
BRAVA RDH-230	42	68	85	65		2700-3000-4000K	5W		V	V		V	V
DEBI RD	44	68	82	65		2700-3000-4000-6000K	6W			V		V	V
IENA RDX	44	68	82	65	30°	2700-3000-4000-6000K	6W			V		V	V
BORA RD EVO	56	68	86	65		2700-3000-4000-6000K	7W			V		V	V
BORA SD EVO	57	68	86x86	65		2700-3000-4000-6000K	7W			V		V	V
BORA RDH EVO	60	68	86	65		2700-3000-4000-6000K	7W			V		V	V
BORA RDX EVO	58	68	86	65	25°	2700-3000-4000-6000K	7W			V		V	V
BORA SDX EVO	59	68	86x86	65	25°	2700-3000-4000-6000K	7W			V		V	V
ALEX RDX	62	68	85	65	25°	2700-3000-4000-6500K	6W			V		V	V
AL1014 RX	68	68	82	44	20°		6W					V	
AL1014 RDX	68	68	82	44	20°		9W			V			
IPHO 82 RD	70	68	83	65			9W	V		V			V
IPHO 82 SD	70	68	83x83	65			9W	V		V			V
SWEET RD EVO	76	68	76	54		2700-3000-4000K	7,5W	V		V		V	
COPE RD	72	68	80	65			7W	V		V			V
EPI RD	72	68	85	65			7W	V		V			V
SILK RDX	78	68	76	44	30°		6W	V		V		V	
ABY 1 RD	82	68	75	23			6,5W			V			
KAHA RDH	54	68	86	65		2700-3000-4000K	7W			V		V	V
KAHA RDX	55	68	86	65	25°	2700-3000-4000K	7W			V		V	V
ELENA L RDH	50	68	76	65		2700-3000-4000K	7,5W	V		V		V	V
SAMY RD	75	72	85	65		2200-2700-3000-4000K	6,5-10W	V		V		V	V
MARY RDX-230	45	75	90	23	30°		7,5W		V	V		V	
AL3012 RD	79	75	82	44			9W			V			
AL3012 RD WARM	79	75	82	44		DIM TO WARM	6W			V		V	
SYLA RD-B	80	75	82	23			10W			V	V		
MODUS EVO 1	66	75	85	20	30°		19W						
MODUS EVO 2	67	75	85	20	30°		21W						
ELENA L RDX	51	75	83	65	20°	2700-3000-4000K	7,5W	V		V		V	V
ABY 2 RD	82	80	85	23			9W			V			
ELENA XL RDH	52	90	98	65		2700-3000-4000K	10W	V		V		V	V
ABY 3 RD	83	92	98	23			15W			V			
DOTS	85	93x35	102x44	20			6W	V		V			
AL1015 RX	69	95	110	23	20°		12W	V					
ALLY 3 RDX	84	105	110	20	45°		10W	V		V			
ELENA XL RDX	53	105	114	65	20°	2700-3000-4000K	10W	V		V		V	V
ALLY 4 RDX	84	128	135	20	45°		14W	V		V			
AL2014 SDX	69	155x78	170x90	23	20°		2x9W			V			
DOTS	85	173x35	182x44	20			12W	V		V			
DOTS	85	253x35	262x44	20			16W	V		V			
DOTS	85	333x35	342x44	20			20W	V		V			



CLASSEMENT PAR DIAMÈTRES D'ENCASTREMENT

SEMI-ENCASTRÉS	PAGE 2026		DIMENSIONS (mm)	IP X	X°	Watt Max	CCT	LED	UGR <19		LAMELLES
FILI 5 RX-B GU10 AUTO	90	58	68	20	90°	10W					V
FILI 5 RDX-B	92	58	67	20	90°			14W		V	V
SIRA R	88	65-180	225	23			3000-4000-6000K	18W			
SIRA R SENSOR IR	88	65-180	225	20			3000-4000-6000K	12W-15W-18W			
CLIC RDX MINI	96	68	78	20	90°			8W	V	V	
ALLY 1 RDX	94	70	75	20	90°			10W	V	V	
ALLY 2 RDX	94	80	93	20	90°			14W	V	V	
OLYN 1 RDX	98	80	90	20	90°		3000-3500-4000K	15W	V	V	
KARL 1 RDX	100	90	100	20	90°		3000-3500-4000K	13W	V	V	
CLIC RDX	96	94	100	20	90°			13W	V	V	
RETI 2 RX	104	95	105	20	90°			18W			
OLYN 2 RDX	99	95	105	20	90°		3000-3500-4000K	15W	V	V	
FILI 1 RX GU10 AUTO	90	102	112	20	45°	10W					
OBIA 1 RX	102	68	77	20	45°		2700-3000-4000K	6W-9W		V	
OBIA 2 RX	102	68	77	20	45°		2700-3000-4000K	6W-9W		V	
RETI 1 RX	104	115	125	20	90°			18W			
KARL 2 RDX	100	120	130	20	90°		3000-3500-4000K	26W	V	V	
FILI 1 RX-B	92	125	136	20	45°			10W			V

DOWNLIGHTS	PAGE 2026		DIMENSIONS (mm)	IP X	X°	CCT	LED	UGR <19			
DAX RD-230	108	68	85	65		2700-3000-4000-6000K	6W		V	V	V
SENSO R-230	108	90	115	44		2700-3000-4000K	9W		V		
LYON 1 R	118	95	110	44			15W	V		En option	
THEA LITE CSP 1	112	100	120	54		3000-4000-6000K	10W			En option	
LYON 2 R	119	125	135	44			25W	V		En option	
AL1016 RX	115	140	158	23	20°		26W	V			
THEA PRO 1	116	145-180	195	65			14W			En option	
THEA LITE CSP 2	113	150	170	54		3000-4000-6500K	14W			En option	
LYON 3 R	120	150	160	44			30W	V		En option	
TIGA 1 RD EVO	110	155	170	44		3000-4000-6000K	10W			V	
IZA 1 SDX	122	162x162	176x176	20	30°	3000-4000K	24W			V	
THEA PRO 2	117	165-200	220	65			25W			En option	
LYON 4 R	121	175	186	44			40W	V		En option	
SPIRA 1 RX PLUS	124	175	186	23	80°	2700-3000-4000K	40W				
THEA LITE CSP 3	113	200	220	54		3000-4000-6500K	20W			En option	
TIGA 2 RD EVO	110	205	220	44		3000-4000-6000K	17W			V	
FOX 2 RD	114	210	240	23			19W			V	V
SPIRA 3 RX	125	215	235	23	80°		60W				
TIGA 3 RD EVO	111	225	240	44		3000-4000-6000K	21W			V	
FOCEA 1 SX PLUS	126	225x135	240x150	23	80°	2700-3000-4000K	40W				
FOCEA 2 SX	126	225x135	240x150	23	80°		60W				
IZA 2 SDX	122	300x162	320x176	20	30°	3000-4000K	2x24W			V	



INDIGO
LIGHTING

COLLERETTES

KASA R GU10



- Spot encastré rond fixe.
- Fixation par ressorts.
- Double bornier automatique.

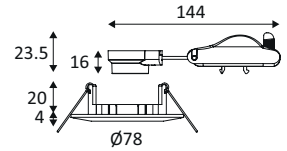

KASA R GU10	COULEUR	MATIÈRE	DOUILLE	LAMPE	WATT MAX	€
DO54605	■ NOIR MAT	ALUMINIUM	GU10	PAR16 LED	10W	6,25
DO54621	■ NICKEL SATINÉ	ALUMINIUM	GU10	PAR16 LED	10W	7,25
DO54630	■ BLANC MAT	ALUMINIUM	GU10	PAR16 LED	10W	6,25
CONVERTISSEURS ET SOURCES			LED	€		
LED9W500DWW	MODU LED 9W 940lm 3000K 38°		9W	49,00		



NOIR MAT



NICKEL SATINÉ



BLANC MAT

KASA RX GU10



- Spot encastré rond orientable.
- Fixation par ressorts.
- Double bornier automatique.

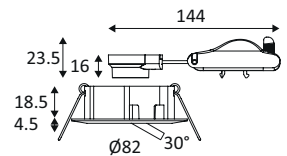

KASA RX GU10	COULEUR	MATIÈRE	DOUILLE	LAMPE	WATT MAX	€
DO54705	■ NOIR MAT	ALUMINIUM	GU10	PAR16 LED	10W	7,25
DO54721	■ NICKEL SATINÉ	ALUMINIUM	GU10	PAR16 LED	10W	8,25
DO54730	■ BLANC MAT	ALUMINIUM	GU10	PAR16 LED	10W	7,25
CONVERTISSEURS ET SOURCES			LED	€		
LED9W500DWW	MODU LED 9W 940lm 3000K 38°		9W	49,00		



NOIR MAT



NICKEL SATINÉ



BLANC MAT



KASA R GU10



ALA1013 RX GU10 AUTO

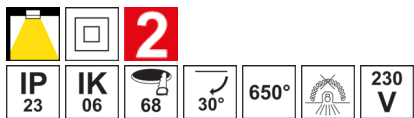

- Spot encastré rond orientable.
- Livré avec ressorts et lamelles.
- Double bornier automatique.
- Bague couvrant un diamètre de perçage de 90 à 120mm à commander séparément.

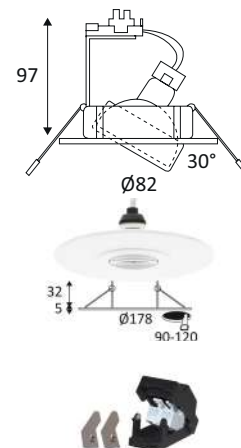

ALA1013 RX GU10 AUTO	COULEUR	MATIÈRE	DOUILLE	LAMPE	WATT MAX	€
DO47505	NOIR MAT	ALUMINIUM	GU10	PAR16 LED	10W	15,50
ALA101325	ALUMINIUM MAT	ALUMINIUM	GU10	PAR16 LED	10W	16,00
ALA101330	BLANC MAT	ALUMINIUM	GU10	PAR16 LED	10W	15,50

ACCESSOIRES	COULEUR	MATIÈRE	DESCRIPTION	€
DO33330	BLANC MAT	ALUMINIUM	BAGUE DE MONTAGE 178MM	18,00
DO33305	NOIR MAT	ALUMINIUM	BAGUE DE MONTAGE 178MM	18,00

CONVERTISSEURS ET SOURCES			LED	€
LED9W500DWW	MODU LED 9W 940Lm 3000K 38°		9W	49,00



NOIR MAT



ALUMINIUM MAT



BLANC MAT



- Spot encastré orientable avec douille GU10.
- Livré avec ressorts et lamelles pour encastrement en faux-plafond ou plafond béton.
- Connexion et repiquage aisés grâce au double bornier automatique.
- Bague couvrant un diamètre de perçage de 90 à 120mm disponible séparément.



ALA1013 SX GU10 AUTO



- Spot encastré carré orientable.
- Fixation par ressorts.
- Double bornier automatique.

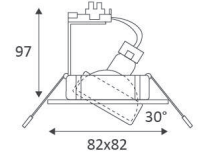

ALA1013 SX GU10 AUTO	COULEUR	MATIÈRE	DOUILLE	LAMPE	WATT MAX	€
DO47605	■ NOIR MAT	ALUMINIUM	GU10	PAR16 LED	10W	24,50
ALA1013S25	■ ALUMINIUM MAT	ALUMINIUM	GU10	PAR16 LED	10W	25,00
ALA1013S30	■ BLANC MAT	ALUMINIUM	GU10	PAR16 LED	10W	24,50
CONVERTISSEURS ET SOURCES					LED	€
LED9W500DWW	MODU LED 9W 940lm 3000K 38°		9W	49,00		



NOIR MAT



ALUMINIUM MAT



BLANC MAT



BALI R GU10

- Spot encastré rond fixe.
- Réflecteur basse luminosité.
- Fixation par ressorts.

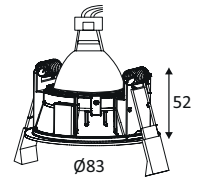

BALI R GU10	COULEUR	MATIÈRE	DOUILLE	LAMPE	WATT MAX	€
DO51305	■ NOIR MAT	ALUMINIUM	GU10	PAR16 LED	10W	24,00
DO51308	■ NOIR MAT - CHAMPAGNE	ALUMINIUM	GU10	PAR16 LED	10W	29,00
DO51317	■ NOIR MAT - ARGENT	ALUMINIUM	GU10	PAR16 LED	10W	29,00
DO51330	■ BLANC MAT	ALUMINIUM	GU10	PAR16 LED	10W	24,00
DO51349	■ BLANC MAT - CHAMPAGNE	ALUMINIUM	GU10	PAR16 LED	10W	29,00
DO51353	■ BLANC MAT - ARGENT	ALUMINIUM	GU10	PAR16 LED	10W	29,00



NOIR MAT

NOIR MAT -
CHAMPAGNE

NOIR MAT - ARGENT



BLANC MAT

BLANC MAT -
CHAMPAGNEBLANC MAT -
ARGENT**FIJI R GU10**

- Spot encastré rond fixe.
- Réflecteur basse luminosité.
- Fixation par ressorts.

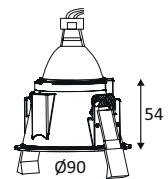

FIJI R GU10	COULEUR	MATIÈRE	DOUILLE	LAMPE	WATT MAX	€
DO51405	■ NOIR MAT	ALUMINIUM	GU10	PAR16 LED	10W	24,00
DO51408	■ NOIR MAT - CHAMPAGNE	ALUMINIUM	GU10	PAR16 LED	10W	29,00
DO51417	■ NOIR MAT - ARGENT	ALUMINIUM	GU10	PAR16 LED	10W	29,00
DO51430	■ BLANC MAT	ALUMINIUM	GU10	PAR16 LED	10W	24,00
DO51449	■ BLANC MAT - CHAMPAGNE	ALUMINIUM	GU10	PAR16 LED	10W	29,00
DO51453	■ BLANC MAT - ARGENT	ALUMINIUM	GU10	PAR16 LED	10W	29,00



NOIR MAT

NOIR MAT -
CHAMPAGNE

NOIR MAT - ARGENT



BLANC MAT

BLANC MAT -
CHAMPAGNEBLANC MAT -
ARGENT



COMO RX GU10

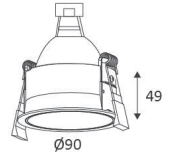

- Spot encastré rond orientable.
- Réflecteur basse luminance.
- Fixation par ressorts.

COMO RX GU10	COULEUR	MATIÈRE	DOUILLE	LAMPE	WATT MAX	€
DO51805	■ NOIR MAT	ALUMINIUM	GU10	PAR16 LED	10W	26,00
DO51808	■ NOIR MAT - CHAMPAGNE	ALUMINIUM	GU10	PAR16 LED	10W	31,00
DO51817	■ NOIR MAT - ARGENT	ALUMINIUM	GU10	PAR16 LED	10W	31,00
DO51830	■ BLANC MAT	ALUMINIUM	GU10	PAR16 LED	10W	26,00
DO51849	■ BLANC MAT - CHAMPAGNE	ALUMINIUM	GU10	PAR16 LED	10W	31,00
DO51853	■ BLANC MAT - ARGENT	ALUMINIUM	GU10	PAR16 LED	10W	31,00



NOIR MAT

NOIR MAT -
CHAMPAGNE

NOIR MAT - ARGENT



BLANC MAT

BLANC MAT -
CHAMPAGNEBLANC MAT -
ARGENT

HD1050 R GU10



- Spot encastré rond fixe.
- Verre de protection sablé.
- Fixation par ressorts.

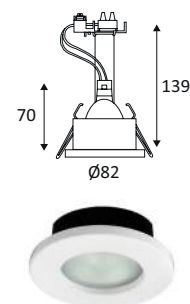

HD1050 R GU10	COULEUR	MATIÈRE	DOUILLE	LAMPE	WATT MAX	€
HD105004	BLANC	ALUMINIUM	GU10	PAR16 LED	10W	18,50
HD105021	NICKEL SATINÉ	ALUMINIUM	GU10	PAR16 LED	10W	19,00



BLANC

NICKEL SATINÉ

HD1070 R GU5.3



- Spot encastré rond fixe.
- Verre de protection sablé.
- Fixation par ressorts.
- Transformateur à commander séparément.

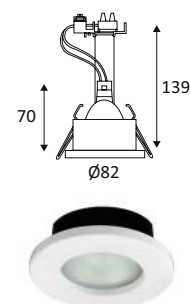

HD1070 R GU5.3	COULEUR	MATIÈRE	DOUILLE	LAMPE	WATT MAX	€
HD107004	BLANC	ALUMINIUM	GU5.3	MR16 LED	10W	18,50
HD107021	NICKEL SATINÉ	ALUMINIUM	GU5.3	MR16 LED	10W	19,00



BLANC

NICKEL SATINÉ

HD1050 R GU10



HD1070 R GU5.3



SPOTS

LASY RX



- Spot encastré rond orientable.
- Fixation par ressorts.
- Peut être recouvert par un isolant déroulé.
- Double bornier automatique.
- Convertisseur non dimmable déporté fourni.

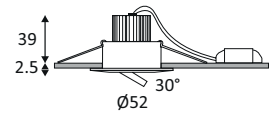

LASY RX	COULEUR	MATIÈRE	P	CCT	LED LUMEN	SYSTEM LUMEN	α	€
DO334WW05	■ NOIR MAT	FONTE D'ALUMINIUM	1W	3000K	130Lm	110Lm	24°	44,00
DO334WW25	■ ALUMINIUM SATINÉ	FONTE D'ALUMINIUM	1W	3000K	130Lm	110Lm	24°	44,00
DO334WW30	■ BLANC MAT	FONTE D'ALUMINIUM	1W	3000K	130Lm	110Lm	24°	44,00



NOIR MAT

ALUMINIUM SATINÉ

BLANC MAT

TIBLI R-B

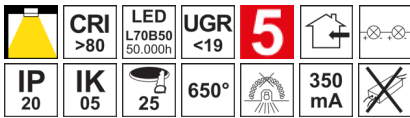

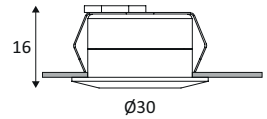

- Spot encastré rond fixe.
- Fixation par lamelles.
- Connecteur rapide et 2.00m de câble inclus.
- Convertisseur dimmable 350mA (montage déporté du convertisseur) à commander séparément (CD167 min. 2, max. 3 TIBLI R-B, compatible avec variateur début et fin de phase).



TIBLI R-B	COULEUR	MATIÈRE	P	CCT	LED LUMEN	SYSTEM LUMEN	α	€
DO468WW05	■ NOIR MAT	ALUMINIUM	1,2W	3000K	115Lm	105Lm	20°	33,00
DO468WW30	■ BLANC MAT	ALUMINIUM	1,2W	3000K	115Lm	105Lm	20°	33,00

CONVERTISSEURS ET SOURCES

			WATT MAX	€	
CD167	DRIVER 2-4W 350MA CC DIM		2-4W	20,00	



NOIR MAT

BLANC MAT



SPOTI R-B

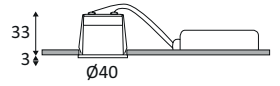
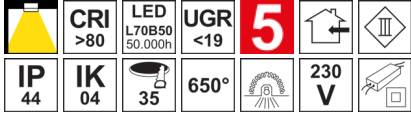

- Spot encastré rond fixe.
- Fixation par lamelles.
- Précâblé 1.50m.
- Peut être recouvert par un isolant déroulé.
- Double bornier automatique.
- Convertisseur non dimmable déporté fourni, peut être placé à max. 10m de l'appareil.



SPOTI R-B	COULEUR	MATIÈRE	P	CCT	LED LUMEN	SYSTEM LUMEN	α	€
DO241SW25	ALUMINIUM	FONTE D'ALUMINIUM	6W	2700K	590Lm	560Lm	24°	60,00
DO241SW30	BLANC MAT	FONTE D'ALUMINIUM	6W	2700K	590Lm	560Lm	24°	60,00
DO241WW25	ALUMINIUM	FONTE D'ALUMINIUM	6W	3000K	620Lm	595Lm	24°	60,00
DO241WW30	BLANC MAT	FONTE D'ALUMINIUM	6W	3000K	620Lm	595Lm	24°	60,00
DO241NW25	ALUMINIUM	FONTE D'ALUMINIUM	6W	4000K	640Lm	605Lm	24°	60,00
DO241NW30	BLANC MAT	FONTE D'ALUMINIUM	6W	4000K	640Lm	605Lm	24°	60,00



ALUMINIUM







BLANC MAT

ANTHRACITE
ANODISÉ

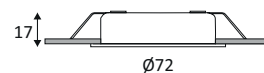
KALI R-230 B

- Spot encastré rond.
- Diffuseur en verre opalin.
- Fixation par lamelles.
- Peut être recouvert par un isolant déroulé.
- Double bornier automatique.
- Ne nécessite pas de convertisseur.
- Non dimmable.
- Accessoire pour pose apparente à commander séparément.



KALI R-230 B	COULEUR	MATIÈRE	P	CCT	LED LUMEN	SYSTEM LUMEN	α	€	
DO337WW05	NOIR MAT	ALUMINIUM	4,7W	3000K	410Lm	290Lm	100°	59,00	
DO337WW21	NICKEL SATINÉ	ALUMINIUM	4,7W	3000K	410Lm	290Lm	100°	59,00	
DO337WW30	BLANC MAT	ALUMINIUM	4,7W	3000K	410Lm	290Lm	100°	59,00	
ACCESSOIRES	COULEUR	MATIÈRE	DESCRIPTION					€	
DO33805	NOIR MAT	ALUMINIUM	BASE RONDE					 ↕20	28,00
DO33821	NICKEL SATINÉ	ALUMINIUM	BASE RONDE					 ↕20	28,00
DO33830	BLANC MAT	ALUMINIUM	BASE RONDE					 ↕20	28,00



NOIR MAT



NICKEL SATINÉ



BLANC MAT





KACI R-B

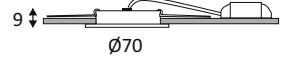

- Spot encastré rond.
- Diffuseur en verre dépoli.
- Fixation par lamelles.
- Précâblé 0.50m.
- Peut être recouvert par un isolant déroulé.
- Double bornier automatique.
- Convertisseur non dimmable déporté fourni, peut être placé à max. 10m de l'appareil.

KACI R-B	COULEUR	MATIÈRE	P	CCT	LED LUMEN	SYSTEM LUMEN	α	€
KC211R25	ALUMINIUM BROSSÉ	ALUMINIUM	3W	3000K	450Lm	335Lm	100°	59,00
KC211R30	BLANC MAT	ALUMINIUM	3W	3000K	450Lm	335Lm	100°	59,00



ALUMINIUM
BROSSÉ



BLANC MAT



LISY RD



- Spot encastré rond fixe.
- Réflecteur basse luminance.
- Fixation par ressorts.
- Convertisseur dimmable déporté fourni.
- Compatible avec variateur début et fin de phase.

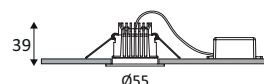

LISY RD	COULEUR	MATIÈRE	P	CCT	LED LUMEN	SYSTEM LUMEN	α	€
DO459WW05	■ NOIR MAT	FONTE D'ALUMINIUM	4,5W	3000K	600Lm	440Lm	36°	62,00
DO459WW30	■ BLANC MAT	FONTE D'ALUMINIUM	4,5W	3000K	600Lm	440Lm	36°	62,00



NOIR MAT



BLANC MAT

LISY RDX

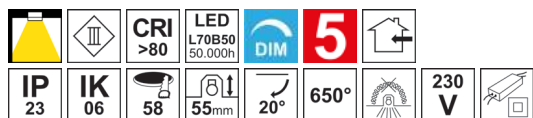

- Spot encastré rond orientable.
- Réflecteur basse luminance.
- Fixation par ressorts.
- Convertisseur dimmable déporté fourni.
- Compatible avec variateur début et fin de phase.

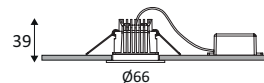

LISY RDX	COULEUR	MATIÈRE	P	CCT	LED LUMEN	SYSTEM LUMEN	α	€
DO460WW05	■ NOIR MAT	FONTE D'ALUMINIUM	4,5W	3000K	600Lm	475Lm	36°	62,00
DO460WW30	■ BLANC MAT	FONTE D'ALUMINIUM	4,5W	3000K	600Lm	475Lm	36°	62,00



NOIR MAT



BLANC MAT



MOWI RD

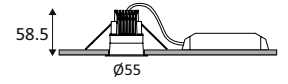

- Spot encastré rond fixe.
- Réflecteur basse luminance.
- Fixation par ressorts.
- Convertisseur dimmable déporté fourni.
- Compatible avec variateur début et fin de phase.



MOWI RD	COULEUR	MATIÈRE	P	CCT	LED LUMEN	SYSTEM LUMEN	α	€
DO467WW05	■ NOIR MAT	FORTE D'ALUMINIUM	6W	3000K	550Lm	295Lm	36°	70,00
DO467WW30	■ BLANC MAT	FORTE D'ALUMINIUM	6W	3000K	550Lm	295Lm	36°	70,00



NOIR MAT



BLANC MAT



TIPI RX



- Spot encastré rond orientable.
- Fixation par ressorts.
- Peut être recouvert par un isolant déroulé.
- Double bornier automatique.
- Convertisseur non dimmable déporté fourni, peut être placé à max. 10m de l'appareil.

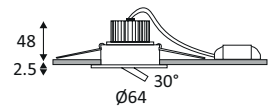

TIPI RX	COULEUR	MATIÈRE	P	CCT	LED LUMEN	SYSTEM LUMEN	α	€
DO104WW05	■ NOIR MAT	FONTE D'ALUMINIUM	3W	3000K	350Lm	300Lm	30°	58,00
DO104WW25	■ ALUMINIUM	FONTE D'ALUMINIUM	3W	3000K	350Lm	300Lm	30°	58,00
DO104WW30	■ BLANC MAT	FONTE D'ALUMINIUM	3W	3000K	350Lm	300Lm	30°	58,00



NOIR MAT



ALUMINIUM



BLANC MAT

TIPI SX



- Spot encastré carré orientable.
- Fixation par ressorts.
- Peut être recouvert par un isolant déroulé.
- Double bornier automatique.
- Convertisseur non dimmable déporté fourni, peut être placé à max. 10m de l'appareil.

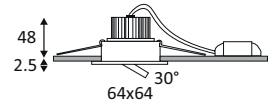

TIPI SX	COULEUR	MATIÈRE	P	CCT	L(MM)	LED LUMEN	SYSTEM LUMEN	α	€
DO103WW05	■ NOIR MAT	FONTE D'ALUMINIUM	3W	3000K	64	350Lm	300Lm	30°	63,00
DO103WW25	■ ALUMINIUM	FONTE D'ALUMINIUM	3W	3000K	64	350Lm	300Lm	30°	63,00
DO103WW30	■ BLANC MAT	FONTE D'ALUMINIUM	3W	3000K	64	350Lm	300Lm	30°	63,00



NOIR MAT



ALUMINIUM



BLANC MAT

TIPI RX



TIPI SX

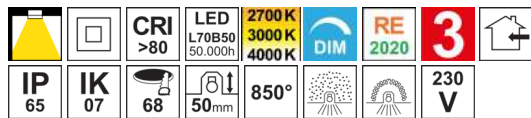

BRAVA RD-230

- Spot encastré rond fixe 3 en 1.
- 2700K, 3000K ou 4000K au choix via un interrupteur à l'arrière du luminaire.
- Fixation par ressorts.
- Peut être recouvert par un isolant déroulé ou soufflé.
- Double bornier automatique.
- Ne nécessite pas de convertisseur.
- Dimmable.
- Compatible avec variateur fin de phase.

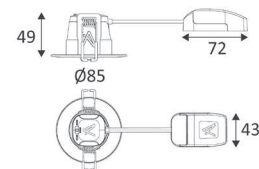

BRAVA RD-230	COULEUR	MATIÈRE	P	CCT	LED LUMEN	SYSTEM LUMEN	α	€
DO54405	NOIR MAT	ALUMINIUM + COMPOSITE	5W	2700K 3000K 4000K	680Lm (4000K)	615Lm (4000K)	60°	25,00
DO54430	BLANC MAT	ALUMINIUM + COMPOSITE	5W	2700K 3000K 4000K	680Lm (4000K)	615Lm (4000K)	60°	25,00



NOIR MAT

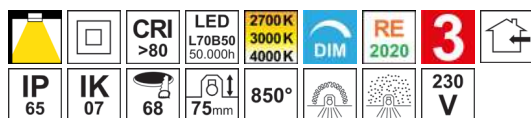

BLANC MAT

BRAVA RDH-230

- Spot encastré rond fixe 3 en 1.
- 2700K, 3000K ou 4000K au choix via un interrupteur à l'arrière du luminaire.
- Réflecteur basse luminance.
- Fixation par ressorts.
- Peut être recouvert par un isolant déroulé ou soufflé.
- Double bornier automatique.
- Ne nécessite pas de convertisseur.
- Dimmable.
- Compatible avec variateur fin de phase.

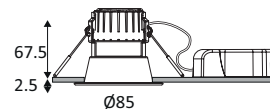

BRAVA RDH-230	COULEUR	MATIÈRE	P	CCT	LED LUMEN	SYSTEM LUMEN	α	€
DO54505	NOIR MAT	ALUMINIUM + COMPOSITE	5W	2700K 3000K 4000K	680Lm (4000K)	400Lm (4000K)	60°	29,00
DO54530	BLANC MAT	ALUMINIUM + COMPOSITE	5W	2700K 3000K 4000K	680Lm (4000K)	555Lm (4000K)	60°	29,00



NOIR MAT



BLANC MAT



BRAVA RDH-230



DEBI RD

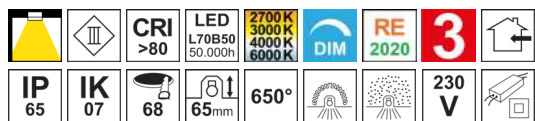

- Spot encastré rond fixe 4 en 1.
- 2700K, 3000K, 4000K ou 6000K au choix via un interrupteur à l'arrière du luminaire.
- Fixation par ressorts.
- Peut être recouvert par un isolant déroulé ou soufflé, convertisseur compris.
- Double bornier automatique.
- Convertisseur dimmable déporté fourni.
- Compatible avec variateur fin de phase.

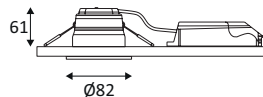

DEBI RD	COULEUR	MATIÈRE	P	CCT	LED LUMEN	SYSTEM LUMEN	α	€
DO43005	■ NOIR MAT	ALUMINIUM + COMPOSITE	6W	3000K 4000K 6500K	720Lm (4000K)	565Lm (4000K)	60°	35,00
DO43030	□ BLANC MAT	ALUMINIUM + COMPOSITE	6W	3000K 4000K 6500K	720Lm (4000K)	565Lm (4000K)	60°	35,00



NOIR MAT



BLANC MAT

IENA RDX

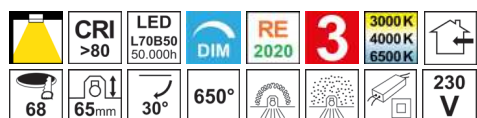

- Spot encastré rond orientable 4 en 1.
- 2700K, 3000K, 4000K ou 6000K au choix via un interrupteur à l'arrière du luminaire.
- Fixation par ressorts.
- Peut être recouvert par un isolant déroulé ou soufflé, convertisseur compris.
- Double bornier automatique.
- Convertisseur dimmable déporté fourni.
- Compatible avec variateur fin de phase.

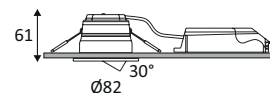

IENA RDX	COULEUR	MATIÈRE	P	CCT	LED LUMEN	SYSTEM LUMEN	α	€
DO43105	■ NOIR MAT	ALUMINIUM + COMPOSITE	6W	3000K 4000K 6500K	720Lm (4000K)	565Lm (4000K)	60°	38,00
DO43130	□ BLANC MAT	ALUMINIUM + COMPOSITE	6W	3000K 4000K 6500K	720Lm (4000K)	565Lm (4000K)	60°	38,00



NOIR MAT



BLANC MAT



DEBI RD



IENA RDX

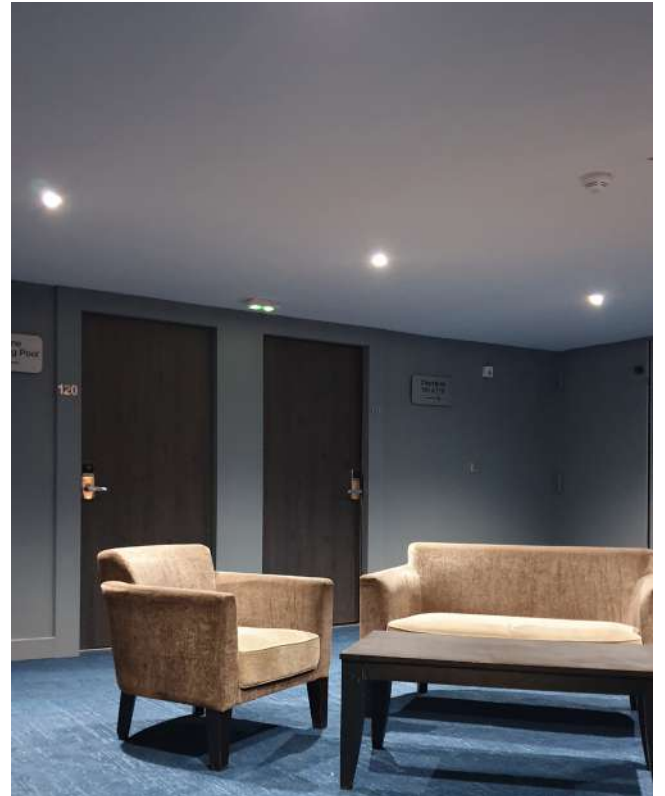

MARY RDX-230

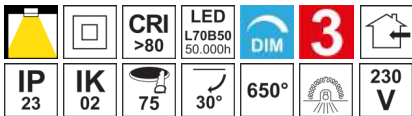

- Spot encastré rond orientable.
- Fixation par ressorts.
- Peut être recouvert par un isolant déroulé.
- Double bornier automatique.
- Ne nécessite pas de convertisseur.
- Dimmable.
- Compatible avec variateur fin de phase.

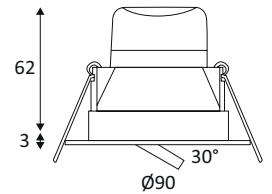

MARY RDX-230	COULEUR	MATIÈRE	P	CCT	LED LUMEN	SYSTEM LUMEN	α	€
DO315WW05	NOIR MAT	COMPOSITE	7,5W	3000K	750Lm	600Lm	60°	35,00
DO315WW30	BLANC MAT	COMPOSITE	7,5W	3000K	750Lm	600Lm	60°	35,00
DO315NW05	NOIR MAT	COMPOSITE	7,5W	4000K	770Lm	615Lm	60°	35,00
DO315NW30	BLANC MAT	COMPOSITE	7,5W	4000K	770Lm	615Lm	60°	35,00



NOIR MAT



BLANC MAT

ELENA S RDH





ELENA S RDH



- Spot encastré rond fixe.
- Réflecteur basse luminance.
- 2700K, 3000K ou 4000K au choix via un interrupteur à l'arrière du luminaire.
- Fixation par ressorts.
- Peut être recouvert par un isolant déroulé ou soufflé, convertisseur compris.
- Convertisseur dimmable par coupure de phase déporté fourni.
- Convertisseur et source de remplacement disponibles séparément.

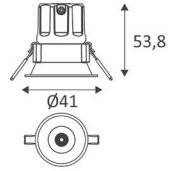

ELENA S RDH	COULEUR	MATIÈRE	P	CCT	LED LUMEN	SYSTEM LUMEN	α	€
DO57305 NEW	NOIR MAT	ALUMINIUM	4W	2700K 3000K 4000K	330Lm (4000K)	231Lm (4000K)	45°	35,00
DO57317 NEW	NOIR MAT - ARGENT	ALUMINIUM	4W	2700K 3000K 4000K	330Lm (4000K)	231Lm (4000K)	45°	45,00
DO57330 NEW	BLANC MAT	ALUMINIUM	4W	2700K 3000K 4000K	330Lm (4000K)	231Lm (4000K)	45°	35,00
DO57335 NEW	NOIR MAT - BLANC MAT	ALUMINIUM	4W	2700K 3000K 4000K	330Lm (4000K)	231Lm (4000K)	45°	45,00
DO57344 NEW	NOIR MAT - LAITON MAT	ALUMINIUM	4W	2700K 3000K 4000K	330Lm (4000K)	231Lm (4000K)	45°	45,00
DO57348 NEW	BLANC MAT - LAITON MAT	ALUMINIUM	4W	2700K 3000K 4000K	330Lm (4000K)	231Lm (4000K)	45°	45,00
DO57353 NEW	BLANC MAT - ARGENT	ALUMINIUM	4W	2700K 3000K 4000K	330Lm (4000K)	231Lm (4000K)	45°	45,00
DO57381 NEW	BLANC MAT - NOIR	ALUMINIUM	4W	2700K 3000K 4000K	330Lm (4000K)	231Lm (4000K)	45°	45,00

CONVERTISSEURS ET SOURCES		€
CDD0573 NEW	DRIVER ELENA S 4W 165MA CC DIM	20,00
LPD0573 NEW	SOURCE LED ELENA S 3W 330Lm 45°	18,00

COULEURS DISPONIBLES POUR TOUTE LA GAMME ELENA

VERSION RDH



VERSION RDX



ELENA M RDH



- Spot encastré rond orientable.
- Réflecteur basse luminance.
- 2700K, 3000K ou 4000K au choix via un interrupteur à l'arrière du luminaire.
- Fixation par ressorts.
- Peut être recouvert par un isolant déroulé ou soufflé, à l'exception du convertisseur DALI.
- Convertisseur dimmable par coupure de phase ou DALI déporté fourni.
- Convertisseur et source de remplacement disponibles séparément.

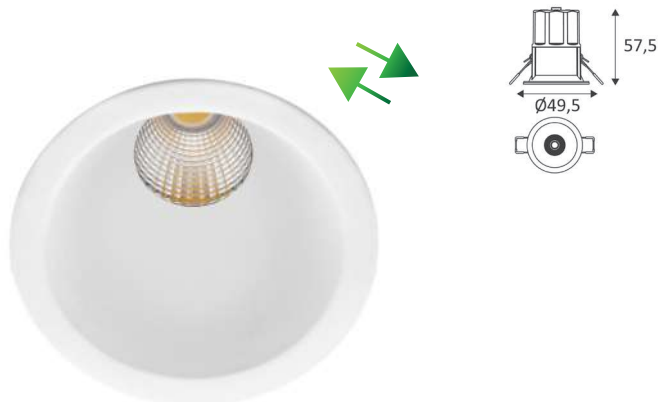

ELENA M RDH	COULEUR	MATIÈRE	P	CCT	LED LUMEN	SYSTEM LUMEN	α	€
DO57405 NEW	NOIR MAT	ALUMINIUM	6W	2700K 3000K 4000K	460Lm (4000K)	356Lm (4000K)	40°	40,00
DO57417 NEW	NOIR MAT - ARGENT	ALUMINIUM	6W	2700K 3000K 4000K	460Lm (4000K)	356Lm (4000K)	40°	50,00
DO57430 NEW	BLANC MAT	ALUMINIUM	6W	2700K 3000K 4000K	460Lm (4000K)	356Lm (4000K)	40°	40,00
DO57435 NEW	NOIR MAT - BLANC MAT	ALUMINIUM	6W	2700K 3000K 4000K	460Lm (4000K)	356Lm (4000K)	40°	50,00
DO57444 NEW	NOIR MAT - LAITON MAT	ALUMINIUM	6W	2700K 3000K 4000K	460Lm (4000K)	356Lm (4000K)	40°	50,00
DO57448 NEW	BLANC MAT - LAITON MAT	ALUMINIUM	6W	2700K 3000K 4000K	460Lm (4000K)	356Lm (4000K)	40°	50,00
DO57453 NEW	BLANC MAT - ARGENT	ALUMINIUM	6W	2700K 3000K 4000K	460Lm (4000K)	356Lm (4000K)	40°	50,00
DO57481 NEW	BLANC MAT - NOIR	ALUMINIUM	6W	2700K 3000K 4000K	460Lm (4000K)	356Lm (4000K)	40°	50,00

CONVERTISSEURS ET SOURCES			€
LPDO578 NEW	SOURCE LED ELENA XL 7,5W 820Lm 45°		24,00
CDDO578 NEW	DRIVER ELENA XL 10W 415MA CC DIM		20,00



ELENA M RDX

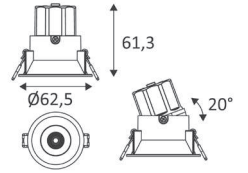

- Spot encastré rond orientable.
- Réflecteur basse luminance.
- 2700K, 3000K ou 4000K au choix via un interrupteur à l'arrière du luminaire.
- Fixation par ressorts.
- Peut être recouvert par un isolant déroulé ou soufflé, convertisseur compris.
- Convertisseur dimmable par coupure de phase déporté fourni.
- Convertisseur et source de remplacement disponibles séparément.

ELENA M RDX	COULEUR	MATIÈRE	P	CCT	LED LUMEN	SYSTEM LUMEN	α	€
DO57505	NEW NOIR MAT	ALUMINIUM	6W	2700K 3000K 4000K	460Lm (4000K)	356Lm (4000K)	40°	45,00
DO57517	NEW NOIR MAT - ARGENT	ALUMINIUM	6W	2700K 3000K 4000K	460Lm (4000K)	356Lm (4000K)	40°	55,00
DO57530	NEW BLANC MAT	ALUMINIUM	6W	2700K 3000K 4000K	460Lm (4000K)	356Lm (4000K)	40°	45,00
DO57535	NEW NOIR MAT - BLANC MAT	ALUMINIUM	6W	2700K 3000K 4000K	460Lm (4000K)	356Lm (4000K)	40°	55,00
DO57544	NEW NOIR MAT - LAITON MAT	ALUMINIUM	6W	2700K 3000K 4000K	460Lm (4000K)	356Lm (4000K)	40°	55,00
DO57548	NEW BLANC MAT - LAITON MAT	ALUMINIUM	6W	2700K 3000K 4000K	460Lm (4000K)	356Lm (4000K)	40°	55,00
DO57553	NEW BLANC MAT - ARGENT	ALUMINIUM	6W	2700K 3000K 4000K	460Lm (4000K)	356Lm (4000K)	40°	55,00
DO57581	NEW BLANC MAT - NOIR	ALUMINIUM	6W	2700K 3000K 4000K	460Lm (4000K)	356Lm (4000K)	40°	55,00

CONVERTISSEURS ET SOURCES			€
CDD0574	NEW DRIVER ELENA M 6W 245MA CC DIM		20,00
LPDO574	NEW SOURCE LED ELENA M 4,5W 460Lm 40°		20,00

ELENA L RDH

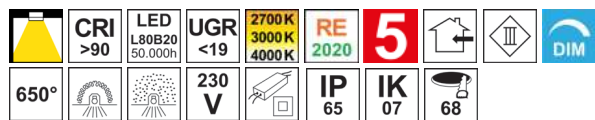

- Spot encastré rond fixe.
- Réflecteur basse luminance.
- 2700K, 3000K ou 4000K au choix via un interrupteur à l'arrière du luminaire.
- Fixation par ressorts.
- Peut être recouvert par un isolant déroulé ou soufflé, à l'exception du convertisseur DALI.
- Convertisseur dimmable par coupure de phase ou DALI déporté fourni.
- Convertisseur et source de remplacement disponibles séparément.

ELENA L RDH	COULEUR	MATIÈRE	P	CCT	LED LUMEN	SYSTEM LUMEN	α	€
DIMMABLE COUPURE DE PHASE								
DO57605	NEW NOIR MAT	ALUMINIUM	7,5W	2700K 3000K 4000K	700Lm (4000K)	502Lm (4000K)	38°	45,00
DO57617	NEW NOIR MAT - ARGENT	ALUMINIUM	7,5W	2700K 3000K 4000K	700Lm (4000K)	502Lm (4000K)	38°	55,00
DO57630	NEW BLANC MAT	ALUMINIUM	7,5W	2700K 3000K 4000K	700Lm (4000K)	502Lm (4000K)	38°	45,00
DO57681	NEW BLANC MAT - NOIR	ALUMINIUM	7,5W	2700K 3000K 4000K	700Lm (4000K)	502Lm (4000K)	38°	55,00
DO57635	NEW NOIR MAT - BLANC MAT	ALUMINIUM	7,5W	2700K 3000K 4000K	700Lm (4000K)	502Lm (4000K)	38°	55,00
DO57644	NEW NOIR MAT - LAITON MAT	ALUMINIUM	7,5W	2700K 3000K 4000K	700Lm (4000K)	502Lm (4000K)	38°	55,00
DO57648	NEW BLANC MAT - LAITON MAT	ALUMINIUM	7,5W	2700K 3000K 4000K	700Lm (4000K)	502Lm (4000K)	38°	55,00
DO57653	NEW BLANC MAT - ARGENT	ALUMINIUM	7,5W	2700K 3000K 4000K	700Lm (4000K)	502Lm (4000K)	38°	55,00
DIMMABLE DALI								
DO58405	NEW NOIR MAT	ALUMINIUM	7,5W	2700K 3000K 4000K	700Lm (4000K)	502Lm (4000K)	38°	95,00
DO58417	NEW NOIR MAT - ARGENT	ALUMINIUM	7,5W	2700K 3000K 4000K	700Lm (4000K)	502Lm (4000K)	38°	105,00
DO58430	NEW BLANC MAT	ALUMINIUM	7,5W	2700K 3000K 4000K	700Lm (4000K)	502Lm (4000K)	38°	95,00
DO58435	NEW NOIR MAT - BLANC MAT	ALUMINIUM	7,5W	2700K 3000K 4000K	700Lm (4000K)	502Lm (4000K)	38°	105,00
DO58444	NEW NOIR MAT - LAITON MAT	ALUMINIUM	7,5W	2700K 3000K 4000K	700Lm (4000K)	502Lm (4000K)	38°	105,00
DO58448	NEW BLANC MAT - LAITON MAT	ALUMINIUM	7,5W	2700K 3000K 4000K	700Lm (4000K)	502Lm (4000K)	38°	105,00
DO58453	NEW BLANC MAT - ARGENT	ALUMINIUM	7,5W	2700K 3000K 4000K	700Lm (4000K)	502Lm (4000K)	38°	105,00
DO58481	NEW BLANC MAT - NOIR	ALUMINIUM	7,5W	2700K 3000K 4000K	700Lm (4000K)	502Lm (4000K)	38°	105,00

CONVERTISSEURS ET SOURCES			€
CDDO576	NEW DRIVER ELENA L 7,5W 320MA CC DIM		20,00
LPDO576	NEW SOURCE LED ELENA L 5,8W 700Lm 38°		22,00
CDDO584	NEW DRIVER ELENA L 14W 350MA CC DALI		40,00



NEW

ELENA L RDX

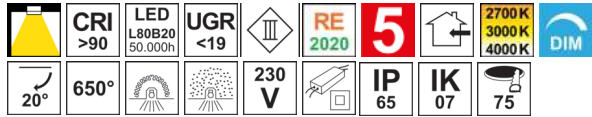

- Spot encastré rond orientable.
- Réflecteur basse luminance.
- 2700K, 3000K ou 4000K au choix via un interrupteur à l'arrière du luminaire.
- Fixation par ressorts.
- Peut être recouvert par un isolant déroulé ou soufflé, à l'exception du convertisseur DALI.
- Convertisseur dimmable par coupure de phase ou DALI déporté fourni.
- Convertisseur et source de remplacement disponibles séparément.

ELENA L RDX	COULEUR	MATIÈRE	P	CCT	LED LUMEN	SYSTEM LUMEN	α	€
DIMMABLE COUPURE DE PHASE								
DO57705	NEW NOIR MAT	ALUMINIUM	7,5W	2700K 3000K 4000K	700Lm (4000K)	502Lm (4000K)	38°	50,00
DO57717	NEW NOIR MAT - ARGENT	ALUMINIUM	7,5W	2700K 3000K 4000K	700Lm (4000K)	502Lm (4000K)	38°	60,00
DO57730	NEW BLANC MAT	ALUMINIUM	7,5W	2700K 3000K 4000K	700Lm (4000K)	502Lm (4000K)	38°	50,00
DO57735	NEW NOIR MAT - BLANC MAT	ALUMINIUM	7,5W	2700K 3000K 4000K	700Lm (4000K)	502Lm (4000K)	38°	60,00
DO57744	NEW NOIR MAT - LAITON MAT	ALUMINIUM	7,5W	2700K 3000K 4000K	700Lm (4000K)	502Lm (4000K)	38°	60,00
DO57748	NEW BLANC MAT - LAITON MAT	ALUMINIUM	7,5W	2700K 3000K 4000K	700Lm (4000K)	502Lm (4000K)	38°	60,00
DO57753	NEW BLANC MAT - ARGENT	ALUMINIUM	7,5W	2700K 3000K 4000K	700Lm (4000K)	502Lm (4000K)	38°	60,00
DO57781	NEW BLANC MAT - NOIR	ALUMINIUM	7,5W	2700K 3000K 4000K	700Lm (4000K)	502Lm (4000K)	38°	60,00
DIMMABLE DALI								
DO58505	NEW NOIR MAT	ALUMINIUM	7,5W	2700K 3000K 4000K	700Lm (4000K)	502Lm (4000K)	38°	100,00
DO58517	NEW NOIR MAT - ARGENT	ALUMINIUM	7,5W	2700K 3000K 4000K	700Lm (4000K)	502Lm (4000K)	38°	110,00
DO58530	NEW BLANC MAT	ALUMINIUM	7,5W	2700K 3000K 4000K	700Lm (4000K)	502Lm (4000K)	38°	100,00
DO58535	NEW NOIR MAT - BLANC MAT	ALUMINIUM	7,5W	2700K 3000K 4000K	700Lm (4000K)	502Lm (4000K)	38°	110,00
DO58544	NEW NOIR MAT - LAITON MAT	ALUMINIUM	7,5W	2700K 3000K 4000K	700Lm (4000K)	502Lm (4000K)	38°	110,00
DO58548	NEW BLANC MAT - LAITON MAT	ALUMINIUM	7,5W	2700K 3000K 4000K	700Lm (4000K)	502Lm (4000K)	38°	110,00
DO58553	NEW BLANC MAT - ARGENT	ALUMINIUM	7,5W	2700K 3000K 4000K	700Lm (4000K)	502Lm (4000K)	38°	110,00
DO58581	NEW BLANC MAT - NOIR	ALUMINIUM	7,5W	2700K 3000K 4000K	700Lm (4000K)	502Lm (4000K)	38°	110,00

CONVERTISSEURS ET SOURCES			€
CDD0576	NEW DRIVER ELENA L 7,5W 320MA CC DIM		20,00
LPD0576	NEW SOURCE LED ELENA L 5,8W 700Lm 38°		22,00
CDD0584	NEW DRIVER ELENA L 14W 350MA CC DALI		40,00

ELENA XL RDH



- Spot encastré rond fixe.
- Réflecteur basse luminance.
- 2700K, 3000K ou 4000K au choix via un interrupteur à l'arrière du luminaire.
- Fixation par ressorts.
- Peut être recouvert par un isolant déroulé ou soufflé, à l'exception du convertisseur DALI.
- Convertisseur dimmable par coupure de phase ou DALI déporté fourni.
- Convertisseur et source de remplacement disponibles séparément.



ELENA XL RDH	COULEUR	MATIÈRE	P	CCT	LED LUMEN	SYSTEM LUMEN	α	€	
DIMMABLE COUPURE DE PHASE									
DO57805	NEW	NOIR MAT	ALUMINIUM	10W	2700K 3000K 4000K	820Lm (4000K)	685Lm (4000K)	45°	50,00
DO57817	NEW	NOIR MAT - ARGENT	ALUMINIUM	10W	2700K 3000K 4000K	820Lm (4000K)	685Lm (4000K)	45°	60,00
DO57830	NEW	BLANC MAT	ALUMINIUM	10W	2700K 3000K 4000K	820Lm (4000K)	685Lm (4000K)	45°	50,00
DO57835	NEW	NOIR MAT - BLANC MAT	ALUMINIUM	10W	2700K 3000K 4000K	820Lm (4000K)	685Lm (4000K)	45°	60,00
DO57844	NEW	NOIR MAT - LAITON MAT	ALUMINIUM	10W	2700K 3000K 4000K	820Lm (4000K)	685Lm (4000K)	45°	60,00
DO57848	NEW	BLANC MAT - LAITON MAT	ALUMINIUM	10W	2700K 3000K 4000K	820Lm (4000K)	685Lm (4000K)	45°	60,00
DO57853	NEW	BLANC MAT - ARGENT	ALUMINIUM	10W	2700K 3000K 4000K	820Lm (4000K)	685Lm (4000K)	45°	60,00
DO57881	NEW	BLANC MAT - NOIR	ALUMINIUM	10W	2700K 3000K 4000K	820Lm (4000K)	685Lm (4000K)	45°	60,00
DIMMABLE DALI									
DO58605	NEW	NOIR MAT	ALUMINIUM	10W	2700K 3000K 4000K	820Lm (4000K)	685Lm (4000K)	45°	100,00
DO58617	NEW	NOIR MAT - ARGENT	ALUMINIUM	10W	2700K 3000K 4000K	820Lm (4000K)	685Lm (4000K)	45°	110,00
DO58630	NEW	BLANC MAT	ALUMINIUM	10W	2700K 3000K 4000K	820Lm (4000K)	685Lm (4000K)	45°	100,00
DO58635	NEW	NOIR MAT - BLANC MAT	ALUMINIUM	10W	2700K 3000K 4000K	820Lm (4000K)	685Lm (4000K)	45°	110,00
DO58644	NEW	NOIR MAT - LAITON MAT	ALUMINIUM	10W	2700K 3000K 4000K	820Lm (4000K)	685Lm (4000K)	45°	110,00
DO58648	NEW	BLANC MAT - LAITON MAT	ALUMINIUM	10W	2700K 3000K 4000K	820Lm (4000K)	685Lm (4000K)	45°	110,00
DO58653	NEW	BLANC MAT - ARGENT	ALUMINIUM	10W	2700K 3000K 4000K	820Lm (4000K)	685Lm (4000K)	45°	110,00
DO58681	NEW	BLANC MAT - NOIR	ALUMINIUM	10W	2700K 3000K 4000K	820Lm (4000K)	685Lm (4000K)	45°	110,00

CONVERTISSEURS ET SOURCES			€
LPDO578	NEW	SOURCE LED ELENA XL 7,5W 820Lm 45°	24,00
CDDO578	NEW	DRIVER ELENA XL 10W 415MA CC DIM	20,00



ELENA XL RDX

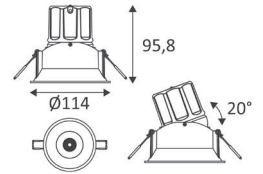

- Spot encastré rond orientable.
- Réflecteur basse luminance.
- 2700K, 3000K ou 4000K au choix via un interrupteur à l'arrière du luminaire.
- Fixation par ressorts.
- Peut être recouvert par un isolant déroulé ou soufflé, à l'exception du convertisseur DALI.
- Convertisseur dimmable par coupure de phase ou DALI déporté fourni.
- Convertisseur et source de remplacement disponibles séparément.

ELENA XL RDX	COULEUR	MATIÈRE	P	CCT	LED LUMEN	SYSTEM LUMEN	α	€
DIMMABLE COUPURE DE PHASE								
DO57905	NEW NOIR MAT	ALUMINIUM	10W	2700K 3000K 4000K	820Lm (4000K)	685Lm (4000K)	45°	55,00
DO57917	NEW NOIR MAT - ARGENT	ALUMINIUM	10W	2700K 3000K 4000K	820Lm (4000K)	685Lm (4000K)	45°	65,00
DO57930	NEW BLANC MAT	ALUMINIUM	10W	2700K 3000K 4000K	820Lm (4000K)	685Lm (4000K)	45°	55,00
DO57935	NEW NOIR MAT - BLANC MAT	ALUMINIUM	10W	2700K 3000K 4000K	820Lm (4000K)	685Lm (4000K)	45°	65,00
DO57944	NEW NOIR MAT - LAITON MAT	ALUMINIUM	10W	2700K 3000K 4000K	820Lm (4000K)	685Lm (4000K)	45°	65,00
DO57948	NEW BLANC MAT - LAITON MAT	ALUMINIUM	10W	2700K 3000K 4000K	820Lm (4000K)	685Lm (4000K)	45°	65,00
DO57953	NEW BLANC MAT - ARGENT	ALUMINIUM	10W	2700K 3000K 4000K	820Lm (4000K)	685Lm (4000K)	45°	65,00
DO57981	NEW BLANC MAT - NOIR	ALUMINIUM	10W	2700K 3000K 4000K	820Lm (4000K)	685Lm (4000K)	45°	65,00
DIMMABLE DALI								
DO58705	NEW NOIR MAT	ALUMINIUM	10W	2700K 3000K 4000K	820Lm (4000K)	685Lm (4000K)	45°	105,00
DO58717	NEW NOIR MAT - ARGENT	ALUMINIUM	10W	2700K 3000K 4000K	820Lm (4000K)	685Lm (4000K)	45°	115,00
DO58730	NEW BLANC MAT	ALUMINIUM	10W	2700K 3000K 4000K	820Lm (4000K)	685Lm (4000K)	45°	105,00
DO58735	NEW NOIR MAT - BLANC MAT	ALUMINIUM	10W	2700K 3000K 4000K	820Lm (4000K)	685Lm (4000K)	45°	115,00
DO58744	NEW NOIR MAT - LAITON MAT	ALUMINIUM	10W	2700K 3000K 4000K	820Lm (4000K)	685Lm (4000K)	45°	115,00
DO58748	NEW BLANC MAT - LAITON MAT	ALUMINIUM	10W	2700K 3000K 4000K	820Lm (4000K)	685Lm (4000K)	45°	115,00
DO58753	NEW BLANC MAT - ARGENT	ALUMINIUM	10W	2700K 3000K 4000K	820Lm (4000K)	685Lm (4000K)	45°	115,00
DO58781	NEW BLANC MAT - NOIR	ALUMINIUM	10W	2700K 3000K 4000K	820Lm (4000K)	685Lm (4000K)	45°	115,00

CONVERTISSEURS ET SOURCES			€
LPDO578	NEW SOURCE LED ELENA XL 7,5W 820Lm 45°		24,00
CDDO578	NEW DRIVER ELENA XL 10W 415MA CC DIM		20,00

KAHA RDH

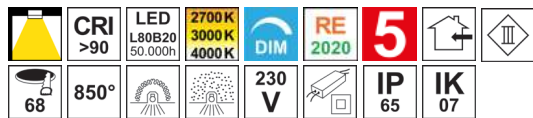

- Spot encastré rond fixe.
- 2700K, 3000K ou 4000K au choix via un interrupteur sur le convertisseur.
- Réflecteur basse luminance.
- Fixation par ressorts.
- Peut être recouvert par un isolant déroulé ou soufflé, convertisseur compris.
- Double bornier automatique.
- Convertisseur dimmable déporté fourni.
- Compatible avec variateur fin de phase.
- Convertisseur ou source de remplacement disponibles séparément.

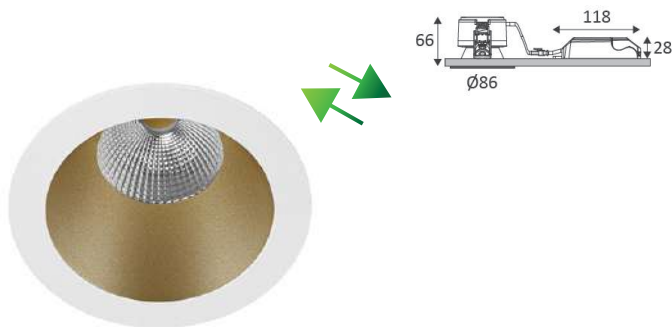

KAHA RDH	COULEUR	MATIÈRE	P	CCT	LED LUMEN	SYSTEM LUMEN	α	€
DO56605	NEW NOIR MAT	ALUMINIUM + COMPOSITE	7W	2700K 3000K 4000K	765Lm (4000K)	420Lm (4000K)	60°	45,00
DO56644	NEW NOIR MAT - LAITON BROSSÉ	ALUMINIUM + COMPOSITE	7W	2700K 3000K 4000K	765Lm (4000K)	480Lm (4000K)	60°	50,00
DO56617	NEW NOIR MAT - ARGENT	ALUMINIUM + COMPOSITE	7W	2700K 3000K 4000K	765Lm (4000K)	480Lm (4000K)	60°	50,00
DO56630	NEW BLANC MAT	ALUMINIUM + COMPOSITE	7W	2700K 3000K 4000K	765Lm(4000K)	480Lm (4000K)	60°	45,00
DO56648	NEW BLANC MAT - LAITON MAT	ALUMINIUM + COMPOSITE	7W	2700K 3000K 4000K	765Lm (4000K)	480Lm (4000K)	60°	50,00
DO56653	NEW BLANC MAT - ARGENT	ALUMINIUM + COMPOSITE	7W	2700K 3000K 4000K	765Lm (4000K)	480Lm (4000K)	60°	50,00

CONVERTISSEURS ET SOURCES		LED	€
LPDO565	NEW SOURCE LED KAHA 4,8W 765Lm 60°	4,8W	30,00
CDDO565	NEW DRIVER KAHA 7W 190MA CC DIM		25,00



NOIR MAT



NOIR MAT - LAITON BROSSÉ



NOIR MAT - ARGENT



BLANC MAT



BLANC MAT - LAITON MAT



BLANC MAT - ARGENT



KAHA RDX



- Spot encastré rond orientable.
- 2700K, 3000K ou 4000K au choix via un interrupteur sur le convertisseur.
- Fixation par ressorts.
- Peut être recouvert par un isolant déroulé ou soufflé, convertisseur compris.
- Double bornier automatique.
- Convertisseur dimmable déporté fourni.
- Compatible avec variateur fin de phase.
- Convertisseur ou source de remplacement disponibles séparément.

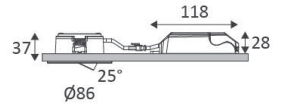

KAHA RDX	COULEUR	MATIÈRE	P	CCT	LED LUMEN	SYSTEM LUMEN	α	€
DO56505 NEW	NOIR MAT	ALUMINIUM + COMPOSITE	7W	2700K 3000K 4000K	765Lm (4000K)	560Lm (4000K)	60°	40,00
DO56530 NEW	BLANC MAT	ALUMINIUM + COMPOSITE	7W	2700K 3000K 4000K	765Lm (4000K)	560Lm (4000K)	60°	40,00

CONVERTISSEURS ET SOURCES	LED	€	
LPDO565 NEW	SOURCE LED KAHA 4,8W 765Lm 60°	4,8W	30,00
CDDO565 NEW	DRIVER KAHA 7W 190MA CC DIM		25,00



NOIR MAT



BLANC MAT



BORA RD EVO

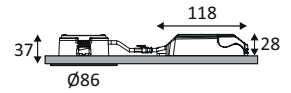

- Spot encastré rond fixe 4 en 1.
- 2700K, 3000K, 4000K ou 6000K au choix via un interrupteur sur le convertisseur.
- Fixation par ressorts.
- Peut être recouvert par un isolant déroulé ou soufflé, convertisseur compris.
- Double bornier automatique.
- Convertisseur dimmable déporté fourni.
- Compatible avec variateur fin de phase.
- Convertisseur ou source de remplacement disponibles séparément.
- Remplaçable



BORA RD EVO	COULEUR	MATIÈRE	P	CCT	LED LUMEN	SYSTEM LUMEN	α	€
DO55105	■ NOIR MAT	ALUMINIUM + COMPOSITE	7W	2700K 3000K 4000K 6000K	800Lm (4000K)	720Lm (4000K)	60°	40,00
DO55121	■ NICKEL SATINÉ	ALUMINIUM + COMPOSITE	7W	2700K 3000K 4000K 6000K	800Lm (4000K)	720Lm (4000K)	60°	40,00
DO55130	■ BLANC MAT	ALUMINIUM + COMPOSITE	7W	2700K 3000K 4000K 6000K	800Lm (4000K)	720Lm (4000K)	60°	40,00

CONVERTISSEURS ET SOURCES		LED	WATT MAX	€
CD553	DRIVER 7W 190MA CC DIM		7W	20,00
LP551	SOURCE LED 5,2W 800Lm 60°		5,2W	12,00



NOIR MAT



NICKEL SATINÉ



BLANC MAT



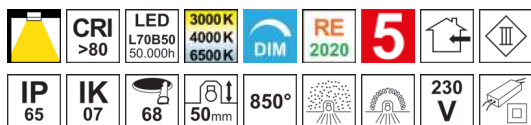

BORA SD EVO

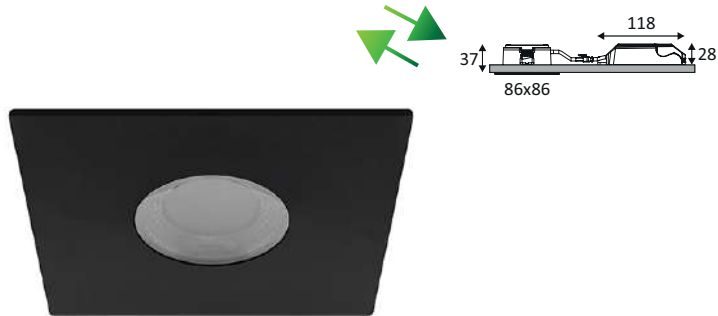

- Spot encastré carré fixe 4 en 1.
- 2700K, 3000K, 4000K ou 6000K au choix via un interrupteur sur le convertisseur.
- Fixation par ressorts.
- Peut être recouvert par un isolant déroulé ou soufflé, convertisseur compris.
- Double bornier automatique.
- Convertisseur dimmable déporté fourni.
- Compatible avec variateur fin de phase.
- Convertisseur ou source de remplacement disponibles séparément.
- Remplaçable



BORA SD EVO	COULEUR	MATIÈRE	P	CCT	L(MM)	LED LUMEN	SYSTEM LUMEN	α	€
DO55405	■ NOIR MAT	ALUMINIUM + COMPOSITE	7W	3000K 4000K 6500K	86	800Lm (4000K)	720Lm (4000K)	60°	46,00
DO55421	■ NICKEL SATINÉ	ALUMINIUM + COMPOSITE	7W	3000K 4000K 6500K	86	800Lm (4000K)	720Lm (4000K)	60°	46,00
DO55430	■ BLANC MAT	ALUMINIUM + COMPOSITE	7W	3000K 4000K 6500K	86	800Lm (4000K)	720Lm (4000K)	60°	46,00

CONVERTISSEURS ET SOURCES			LED	WATT MAX	€
CD553	DRIVER 7W 190MA CC DIM			7W	20,00
LP551	SOURCE LED 5,2W 800Lm 60°		5,2W		12,00



NOIR MAT

NICKEL SATINÉ

BLANC MAT

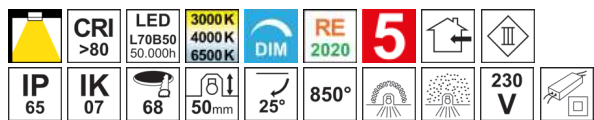

BORA RDX EVO

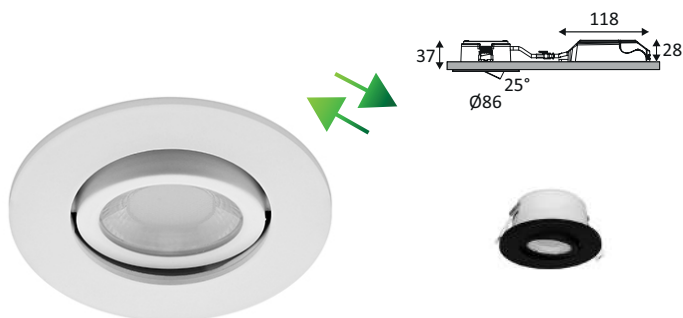

- Spot encastré rond orientable 4 en 1.
- 2700K, 3000K, 4000K ou 6000K au choix via un interrupteur sur le convertisseur.
- Fixation par ressorts.
- Peut être recouvert par un isolant déroulé ou soufflé, convertisseur compris.
- Double bornier automatique.
- Convertisseur dimmable déporté fourni.
- Compatible avec variateur fin de phase.
- Convertisseur ou source de remplacement disponibles séparément.



BORA RDX EVO	COULEUR	MATIÈRE	P	CCT	LED LUMEN	SYSTEM LUMEN	α	€
DO55205	■ NOIR MAT	ALUMINIUM + COMPOSITE	7W	3000K 4000K 6500K	800Lm (4000K)	720Lm (4000K)	60°	46,00
DO55221	■ NICKEL SATINÉ	ALUMINIUM + COMPOSITE	7W	3000K 4000K 6500K	800Lm (4000K)	720Lm (4000K)	60°	46,00
DO55230	■ BLANC MAT	ALUMINIUM + COMPOSITE	7W	3000K 4000K 6500K	800Lm (4000K)	720Lm (4000K)	60°	46,00

CONVERTISSEURS ET SOURCES		LED	WATT MAX	€
CD553	DRIVER 7W 190MA CC DIM		7W	20,00
LP551	SOURCE LED 5,2W 800Lm 60°		5,2W	12,00



NOIR MAT



NICKEL SATINÉ



BLANC MAT





BORA SDX EVO

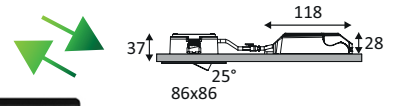

- Spot encastré carré orientable 4 en 1.
- 2700K, 3000K, 4000K ou 6000K au choix via un interrupteur sur le convertisseur.
- Fixation par ressorts.
- Peut être recouvert par un isolant déroulé ou soufflé, convertisseur compris.
- Double bornier automatique.
- Convertisseur dimmable déporté fourni.
- Compatible avec variateur fin de phase.
- Convertisseur ou source de remplacement disponibles séparément.

BORA SDX EVO	COULEUR	MATIÈRE	P	CCT	LED LUMEN	SYSTEM LUMEN	α	€
DO55505	NOIR MAT	ALUMINIUM + COMPOSITE	7W	2700K 3000K 4000K 6000K	800Lm (4000K)	720Lm (4000K)	60°	50,00
DO55521	NICKEL SATINÉ	ALUMINIUM + COMPOSITE	7W	2700K 3000K 4000K 6000K	800Lm (4000K)	720Lm (4000K)	60°	50,00
DO55530	BLANC MAT	ALUMINIUM + COMPOSITE	7W	2700K 3000K 4000K 6000K	800Lm (4000K)	720Lm (4000K)	60°	50,00

CONVERTISSEURS ET SOURCES			LED	WATT MAX	€
CD553	DRIVER 7W 190MA CC DIM			7W	20,00
LP551	SOURCE LED 5,2W 800Lm 60°		5,2W		12,00



NOIR MAT NICKEL SATINÉ BLANC MAT



BORA RDH EVO



- Spot encastré rond fixe 4 en 1.
- 2700K, 3000K, 4000K ou 6000K au choix via un interrupteur sur le convertisseur.
- Réflecteur basse luminance.
- Fixation par ressorts.
- Peut être recouvert par un isolant déroulé ou soufflé, convertisseur compris.
- Double bornier automatique.
- Convertisseur dimmable déporté fourni.
- Compatible avec variateur fin de phase.
- Convertisseur ou source de remplacement disponibles séparément.

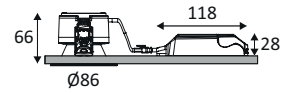

BORA RDH EVO	COULEUR	MATIÈRE	P	CCT	LED LUMEN	SYSTEM LUMEN	α	€
DO55305	■ NOIR MAT	ALUMINIUM + COMPOSITE	7W	2700K 3000K 4000K 6000K	800Lm (4000K)	565Lm (4000K)	60°	43,00
DO55344	■ NOIR MAT - LAITON MAT	ALUMINIUM + COMPOSITE	7W	2700K 3000K 4000K 6000K	800Lm (4000K)	615Lm (4000K)	60°	50,00
DO55317	■ NOIR MAT - ARGENT	ALUMINIUM + COMPOSITE	7W	2700K 3000K 4000K 6000K	800Lm (4000K)	645Lm (4000K)	60°	50,00
DO55330	■ BLANC MAT	ALUMINIUM + COMPOSITE	7W	2700K 3000K 4000K 6000K	800Lm (4000K)	665Lm (4000K)	60°	43,00
DO55348	■ BLANC MAT - LAITON MAT	ALUMINIUM + COMPOSITE	7W	2700K 3000K 4000K 6000K	800Lm (4000K)	640Lm (4000K)	60°	50,00
DO55353	■ BLANC MAT - ARGENT	ALUMINIUM + COMPOSITE	7W	2700K 3000K 4000K 6000K	800Lm (4000K)	640Lm (4000K)	60°	50,00

CONVERTISSEURS ET SOURCES		LED	WATT MAX	€
CD553	DRIVER 7W 190MA CC DIM		7W	20,00
LP551	SOURCE LED 5,2W 800Lm 60°		5,2W	12,00

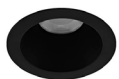

NOIR MAT



NOIR MAT - LAITON MAT

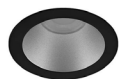

NOIR MAT - ARGENT



BLANC MAT



BLANC MAT - LAITON MAT

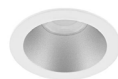

BLANC MAT - ARGENT

BORA RDH EVO



ALEX RDX



- Spot encastré rond orientable 4 en 1.
- 2700K, 3000K, 4000K ou 6500K au choix via un interrupteur sur le convertisseur.
- Fixation par ressorts.
- Peut être recouvert par un isolant déroulé ou soufflé, convertisseur compris.
- Double bornier automatique.
- Convertisseur dimmable déporté fourni.
- Compatible avec variateur début et fin de phase.
- Driver ou spot de remplacement disponibles séparément.

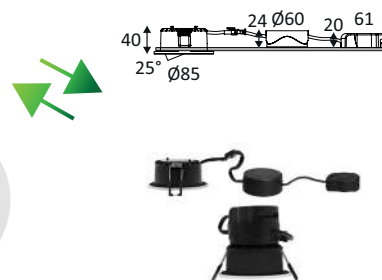

ALEX RDX	COULEUR	MATIÈRE	P	CCT	LED LUMEN	SYSTEM LUMEN	α	€
DO53305	■ NOIR MAT	ALUMINIUM + COMPOSITE	6W	2700K 3000K 4000K 6500K	700Lm (4000K)	575Lm (4000K)	60°	46,00
DO53321	■ NICKEL SATINÉ	ALUMINIUM + COMPOSITE	6W	2700K 3000K 4000K 6500K	700Lm (4000K)	575Lm (4000K)	60°	46,00
DO53330	■ BLANC MAT	ALUMINIUM + COMPOSITE	6W	2700K 3000K 4000K 6500K	700Lm (4000K)	575Lm (4000K)	60°	46,00

CONVERTISSEURS ET SOURCES		WATT MAX	€
CD533	DRIVER 6W 260MA CC DIM	6W	22,00
LP53305	SPOT 6W 700Lm 60° IP65		20,00
LP53321	SPOT 6W 700Lm 60° IP65		20,00
LP53330	SPOT 6W 700Lm 60° IP65		20,00



NOIR MAT



NICKEL SATINÉ



BLANC MAT



ALEX RDX



KORY R

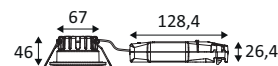

- Spot encastré rond fixe 3 en 1.
- 2700K, 3000K ou 4000K au choix via un interrupteur dans le luminaire.
- Fixation par ressorts.
- Peut être recouvert par un isolant déroulé ou soufflé, convertisseur compris.
- Double bornier automatique.
- Convertisseur non dimmable déporté fourni.



KORY R	COULEUR	MATIÈRE	P	CCT	LED LUMEN	SYSTEM LUMEN	α	€
DO54905	■ NOIR MAT	ALUMINIUM + COMPOSITE	6W	2700K 3000K 4000K	775Lm (4000K)	620Lm (4000K)	60°	37,00
DO54930	□ BLANC MAT	ALUMINIUM + COMPOSITE	6W	2700K 3000K 4000K	775Lm (4000K)	665Lm (4000K)	60°	37,00



NOIR MAT



BLANC MAT

KORY R SENSOR

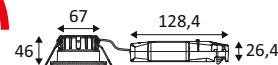
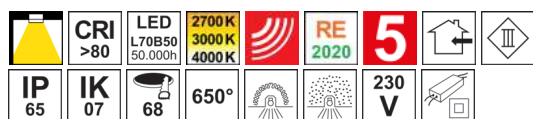

- Spot encastré rond fixe 3 en 1.
- 2700K, 3000K ou 4000K au choix via un interrupteur dans le luminaire.
- Fixation par ressorts.
- Peut être recouvert par un isolant déroulé ou soufflé, convertisseur compris.
- Double bornier automatique.
- Avec détecteur IR 90°, zone de détection max. 4m de diamètre.
- Fonction maître/esclave possible en association avec le KORY R.
- Convertisseur non dimmable déporté fourni.



KORY R SENSOR	COULEUR	MATIÈRE	P	CCT	LED LUMEN	SYSTEM LUMEN	α	€
DO55005	■ NOIR MAT	ALUMINIUM + COMPOSITE	6W	2700K 3000K 4000K	775Lm (4000K)	620Lm (4000K)	60°	45,00
DO55030	□ BLANC MAT	ALUMINIUM + COMPOSITE	6W	2700K 3000K 4000K	775Lm (4000K)	665Lm (4000K)	60°	45,00



NOIR MAT



BLANC MAT



KORY R SENSOR



MODUS EVO 1



- Spot encastré orientable.
- Réflecteur basse luminance.
- Disponible en rond (MV0R) ou carré (MV0S).
- Fixation par ressorts (MV0_/C) ou trimless (MV0_/T).
- Simple bornier automatique.
- Convertisseur non-dimmable déporté fourni.

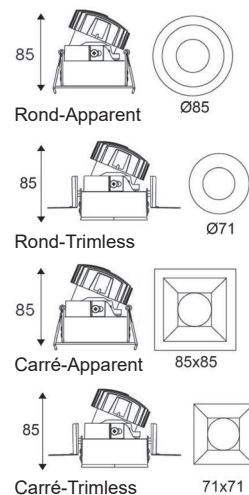

MODUS EVO 1	COULEUR	MATIÈRE	P	CCT	LED LUMEN	SYSTEM LUMEN	α	€
ROND								
APPARENT								
MV0R/BCW/3K07/B6	NOIR MAT	ALUMINIUM	9W	3000K	800Lm	705Lm	60°	80,00
MV0R/WCW/3K07/W6	BLANC MAT	ALUMINIUM	9W	3000K	800Lm	705Lm	60°	80,00
MV0R/BCW/3K11/B6	NOIR MAT	ALUMINIUM	13W	3000K	1000Lm	912Lm	60°	85,00
MV0R/WCW/3K11/W6	BLANC MAT	ALUMINIUM	13W	3000K	1000Lm	912Lm	60°	85,00
TRIMLESS								
MV0R/TW/3K07/B6	NOIR MAT	ALUMINIUM	9W	3000K	800Lm	705Lm	60°	95,00
MV0R/TW/3K07/W6	BLANC MAT	ALUMINIUM	9W	3000K	800Lm	705Lm	60°	95,00
MV0R/TW/3K11/B6	NOIR MAT	ALUMINIUM	13W	3000K	1000Lm	912Lm	60°	100,00
MV0R/TW/3K11/W6	BLANC MAT	ALUMINIUM	13W	3000K	1000Lm	912Lm	60°	100,00
CARRÉ								
APPARENT								
MV0S/BCW/3K07/B6	NOIR MAT	ALUMINIUM	9W	3000K	800Lm	705Lm	60°	85,00
MV0S/WCW/3K07/W6	BLANC MAT	ALUMINIUM	9W	3000K	800Lm	705Lm	60°	85,00
MV0S/BCW/3K11/B6	NOIR MAT	ALUMINIUM	13W	3000K	1000Lm	912Lm	60°	90,00
MV0S/WCW/3K11/W6	BLANC MAT	ALUMINIUM	13W	3000K	1000Lm	912Lm	60°	90,00
TRIMLESS								
MV0S/TW/3K07/B6	NOIR MAT	ALUMINIUM	9W	3000K	800Lm	705Lm	60°	100,00
MV0S/TW/3K07/W6	BLANC MAT	ALUMINIUM	9W	3000K	800Lm	705Lm	60°	100,00
MV0S/TW/3K11/B6	NOIR MAT	ALUMINIUM	13W	3000K	1000Lm	912Lm	60°	105,00
MV0S/TW/3K11/W6	BLANC MAT	ALUMINIUM	13W	3000K	1000Lm	912Lm	60°	105,00

Filtres pour MODUS EVO			€
MV		DESCRIPTION	
MV/ASY	NEW	FILTRE ASYMÉTRIQUE	8,00
MV/D/ASY	NEW	FILTRE DOUBLE ASYMÉTRIQUE	8,00
MV/DIFFUSE	NEW	FILTRE DIFFUS	8,00
MV/HONEYCOMB	NEW	FILTRE NID D'ABEILLE	8,00
MV/LINEAR	NEW	FILTRE LINÉAIRE	8,00



NOIR MAT



BLANC MAT



NOIR MAT



BLANC MAT



NOIR MAT



BLANC MAT



NOIR MAT



BLANC MAT





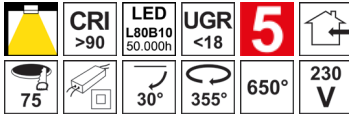



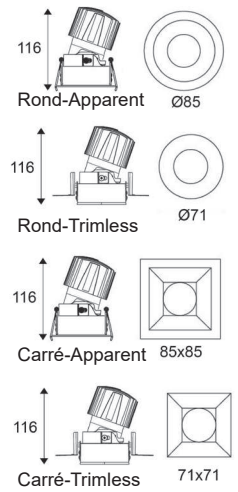

MODUS EVO 2



- Spot encastré orientable.
- Réflecteur basse luminance.
- Disponible en rond (MV1R) ou carré (MV1S).
- Fixation par ressorts (MV1/_C) ou trimless (MV1/_T).
- Simple bornier automatique.
- Convertisseur non-dimmable déporté fourni.



MODUS EVO 2	COULEUR	MATIÈRE	P	CCT	LED LUMEN	SYSTEM LUMEN	α	€
ROND								
APPARENT								
 MV1R/BCW/3K18/B6 NEW	NOIR MAT	ALUMINIUM	21W	3000K	1750Lm	1554Lm	50°	130,00
 MV1R/WCW/3K18/W6 NEW	BLANC MAT	ALUMINIUM	21W	3000K	1750Lm	1554Lm	50°	130,00
TRIMLESS								
 MV1R/TW/3K18/B6 NEW	NOIR MAT	ALUMINIUM	21W	3000K	1750Lm	1554Lm	50°	145,00
 MV1R/TW/3K18/W6 NEW	BLANC MAT	ALUMINIUM	21W	3000K	1750Lm	1554Lm	50°	145,00
CARRÉ								
APPARENT								
 MV1S/BCW/3K18/B6 NEW	NOIR MAT	ALUMINIUM	21W	3000K	1750Lm	1554Lm	50°	135,00
 MV1S/WCW/3K18/W6 NEW	BLANC MAT	ALUMINIUM	21W	3000K	1750Lm	1554Lm	50°	135,00
TRIMLESS								
 MV1S/TW/3K18/B6 NEW	NOIR MAT	ALUMINIUM	21W	3000K	1750Lm	1554Lm	50°	145,00
 MV1S/TW/3K18/W6 NEW	BLANC MAT	ALUMINIUM	21W	3000K	1750Lm	1554Lm	50°	145,00

Filtres pour MODUS EVO			€
MV		DESCRIPTION	
MV/ASY	NEW	FILTRE ASYMÉTRIQUE	8,00
MV/D/ASY	NEW	FILTRE DOUBLE ASYMÉTRIQUE	8,00
MV/DIFFUSE	NEW	FILTRE DIFFUS	8,00
MV/HONEYCOMB	NEW	FILTRE NID D'ABEILLE	8,00
MV/LINEAR	NEW	FILTRE LINÉAIRE	8,00



NOIR MAT



BLANC MAT



NOIR MAT



BLANC MAT



NOIR MAT



BLANC MAT



NOIR MAT



BLANC MAT

AL1014 RX



- Spot encastré rond orientable.
- Fixation par ressorts.
- Peut être recouvert par un isolant déroulé.
- Double bornier automatique.
- Convertisseur non dimmable déporté fourni.
- Bague couvrant un diamètre de perçage de 90 à 120mm à commander séparément.

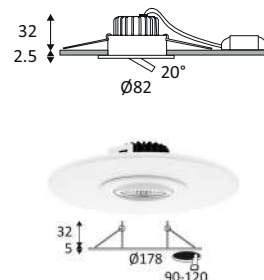

AL1014 RX	COULEUR	MATIÈRE	P	CCT	LED LUMEN	SYSTEM LUMEN	α	€
AL101425	ALUMINIUM	FONTE D'ALUMINIUM	6W	3000K	760Lm	655Lm	38°	44,00
DO11525	ALUMINIUM	FONTE D'ALUMINIUM	6W	4000K	820Lm	705Lm	38°	50,00
DO11530	BLANC MAT	FONTE D'ALUMINIUM	6W	4000K	820Lm	705Lm	38°	50,00

ACCESSOIRES	COULEUR	MATIÈRE	DESCRIPTION	€
DO33330	BLANC MAT	ALUMINIUM	BAGUE DE MONTAGE 178MM	18,00



ALUMINIUM



BLANC MAT

AL1014 RDX



- Spot encastré rond orientable.
- Fixation par ressorts.
- Double bornier automatique.
- Convertisseur dimmable déporté fourni.
- Compatible avec variateur début et fin de phase.
- Bague couvrant un diamètre de perçage de 90 à 120mm à commander séparément.

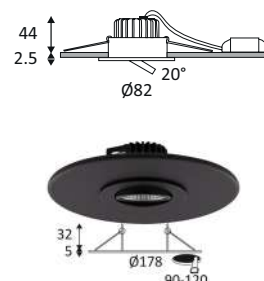

AL1014 RDX	COULEUR	MATIÈRE	P	CCT	LED LUMEN	SYSTEM LUMEN	α	€
DO16005	NOIR MAT	FONTE D'ALUMINIUM	9W	3000K	940Lm	830Lm	38°	60,00
DO16025	ALUMINIUM	FONTE D'ALUMINIUM	9W	3000K	940Lm	830Lm	38°	60,00
DO16030	BLANC MAT	FONTE D'ALUMINIUM	9W	3000K	940Lm	830Lm	38°	60,00

ACCESSOIRES	COULEUR	MATIÈRE	DESCRIPTION	€
DO33305	NOIR MAT	ALUMINIUM	BAGUE DE MONTAGE 178MM	18,00
DO33330	BLANC MAT	ALUMINIUM	BAGUE DE MONTAGE 178MM	18,00



NOIR MAT



ALUMINIUM



BLANC MAT



AL2014 SDX

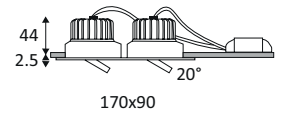
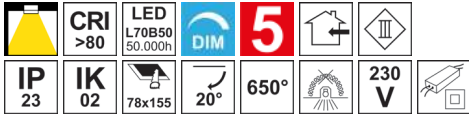

- Spot encastré rectangulaire orientable.
- Fixation par ressorts.
- Double bornier automatique.
- Convertisseur dimmable déporté fourni.
- Compatible avec variateur début et fin de phase.

AL2014 SDX	COULEUR	MATIÈRE	P	CCT	LED LUMEN	SYSTEM LUMEN	α	€
DO18205	■ NOIR MAT	FONTE D'ALUMINIUM	18W	3000K	2X900Lm	1570Lm	38°	160,00
DO18230	■ BLANC MAT	FONTE D'ALUMINIUM	18W	3000K	2X900Lm	1570Lm	38°	160,00



NOIR MAT

BLANC MAT

AL1015 RX

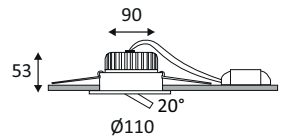

- Spot encastré rond orientable.
- Fixation par ressorts.
- Convertisseur non dimmable déporté fourni.
- En option, convertisseur dimmable DALI-PUSH CD140 à commander séparément.

AL1015 RX	COULEUR	MATIÈRE	P	CCT	LED LUMEN	SYSTEM LUMEN	α	€
DO108WW05	■ NOIR MAT	FONTE D'ALUMINIUM	12W	3000K	1320Lm	1170Lm	38°	117,00
AL1015WW30	■ BLANC MAT	FONTE D'ALUMINIUM	12W	3000K	1320Lm	1170Lm	38°	117,00
DO108NW05	■ NOIR MAT	FONTE D'ALUMINIUM	12W	4000K	1200Lm	1000Lm	38°	117,00
DO108NW30	■ BLANC MAT	FONTE D'ALUMINIUM	12W	4000K	1470Lm	1300Lm	38°	117,00

CONVERTISSEURS ET SOURCES	WATT MAX	€
CD140	DRIVER 3-18W 350MA CC DIM DALI	90,00



NOIR MAT



BLANC MAT

IPHO 82 RD



- Spot encastré rond fixe.
- Fixation par ressorts.
- Double bornier automatique.
- Convertisseur dimmable déporté fourni.
- Compatible avec variateur début et fin de phase.

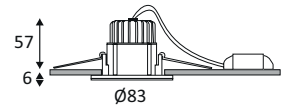

IPHO 82 RD	COULEUR	MATIÈRE	P	CCT	LED LUMEN	SYSTEM LUMEN	α	€
DO16405	NOIR	VERRE	9W	3000K	900Lm	620Lm	38°	95,00
DO16430	BLANC	VERRE	9W	3000K	900Lm	705Lm	38°	95,00



NOIR



BLANC

IPHO 82 SD



- Spot encastré carré fixe.
- Fixation par ressorts.
- Double bornier automatique.
- Convertisseur dimmable déporté fourni.
- Compatible avec variateur début et fin de phase.

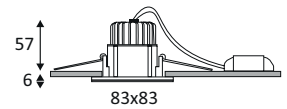

IPHO 82 SD	COULEUR	MATIÈRE	P	CCT	LED LUMEN	SYSTEM LUMEN	α	€
DO16505	NOIR	VERRE	9W	3000K	900Lm	620Lm	38°	95,00
DO16530	BLANC	VERRE	9W	3000K	900Lm	705Lm	38°	95,00



NOIR



BLANC



IPHO 82 SD

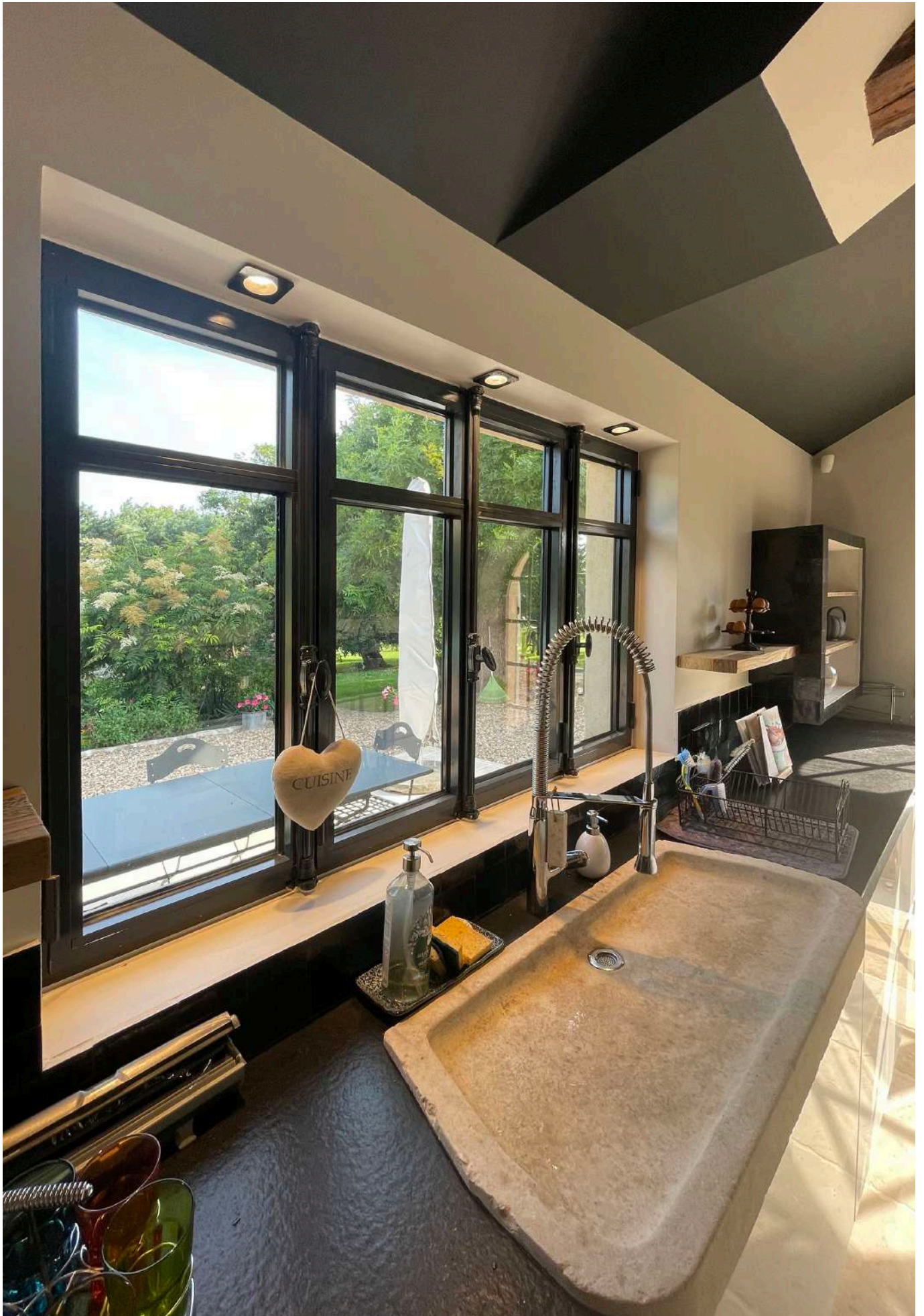

COPE RD

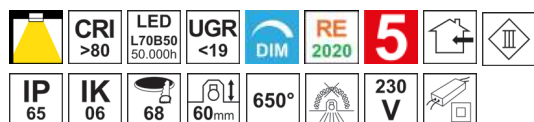

- Spot encastré rond fixe.
- Réflecteur basse luminance.
- Fixation par ressorts.
- Convertisseur dimmable déporté fourni.
- Compatible avec variateur début et fin de phase.

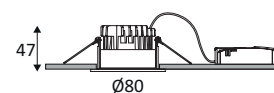

COPE RD	COULEUR	MATIÈRE	P	CCT	LED LUMEN	SYSTEM LUMEN	α	€
DO465WW05	NOIR MAT	FONTE D'ALUMINIUM	7W	3000K	750Lm	620Lm	36°	75,00
DO465WW30	BLANC MAT	FONTE D'ALUMINIUM	7W	3000K	750Lm	620Lm	36°	75,00
DO465NW05	NOIR MAT	FONTE D'ALUMINIUM	7W	4000K	800Lm	645Lm	36°	75,00
DO465NW30	BLANC MAT	FONTE D'ALUMINIUM	7W	4000K	800Lm	645Lm	36°	75,00



NOIR MAT



BLANC MAT

EPI RD

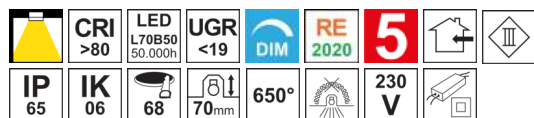

- Spot encastré rond fixe.
- Réflecteur basse luminance.
- Fixation par ressorts.
- Convertisseur dimmable déporté fourni.
- Compatible avec variateur début et fin de phase.

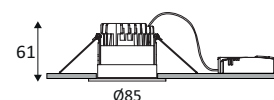

EPI RD	COULEUR	MATIÈRE	P	CCT	LED LUMEN	SYSTEM LUMEN	α	€
DO466WW05	NOIR MAT	FONTE D'ALUMINIUM	7W	3000K	750Lm	570Lm	36°	80,00
DO466WW30	BLANC MAT	FONTE D'ALUMINIUM	7W	3000K	750Lm	570Lm	36°	80,00
DO466NW05	NOIR MAT	FONTE D'ALUMINIUM	7W	4000K	800Lm	600Lm	36°	80,00
DO466NW30	BLANC MAT	FONTE D'ALUMINIUM	7W	4000K	800Lm	600Lm	36°	80,00



NOIR MAT



BLANC MAT



EPI RD

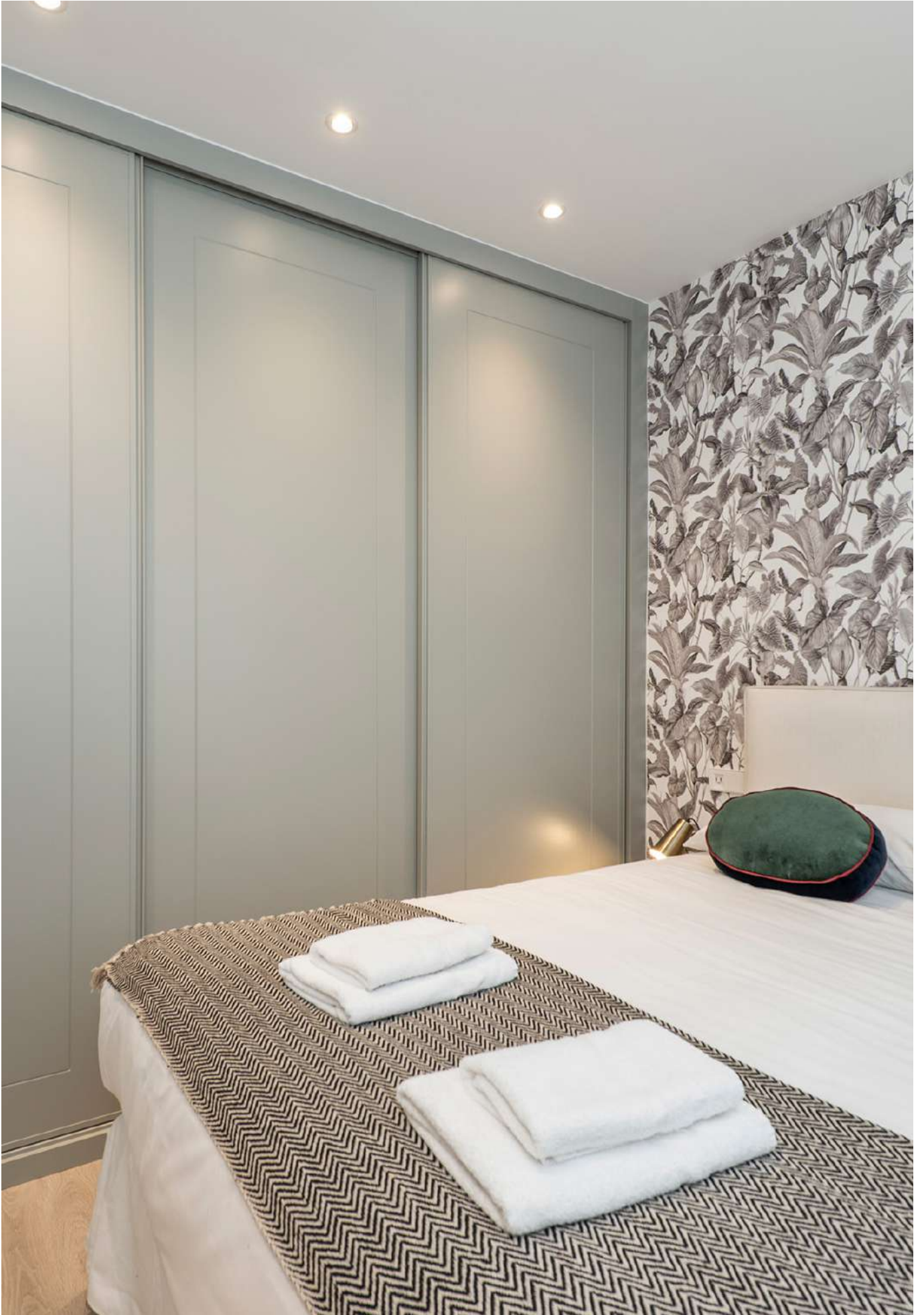

SAMY RD





SAMY RD

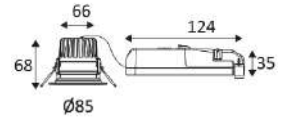

- Spot encastré rond fixe.
- 2200K, 2700K, 3000K ou 4000K au choix via un interrupteur dans le luminaire.
- Réflecteur basse luminance.
- Fixation par ressorts.
- Peut être recouvert par un isolant déroulé ou soufflé, à l'exception du convertisseur DALI.
- Double bornier automatique.
- Convertisseur dimmable par coupure de phase ou DALI déporté fourni.

SAMY RD	COULEUR	MATIÈRE	P	CCT	LED LUMEN	SYSTEM LUMEN	α	€	
DIMMABLE COUPURE DE PHASE									
DO58005	NEW	NOIR MAT	ACIER + COMPOSITE	6,5-10W	2200K 2700K 3000K 4000K	1200Lm (4000K)	900Lm (4000K)	40°	50,00
DO58030	NEW	BLANC MAT	ACIER + COMPOSITE	6,5-10W	2200K 2700K 3000K 4000K	1200Lm (4000K)	1000Lm (4000K)	40°	50,00
DIMMABLE DALI									
DO58305	NEW	NOIR MAT	ACIER + COMPOSITE	10W	2200K 2700K 3000K 4000K	1200Lm (4000K)	900Lm (4000K)	40°	90,00
DO58330	NEW	BLANC MAT	ACIER + COMPOSITE	10W	2200K 2700K 3000K 4000K	1200Lm (4000K)	1000Lm (4000K)	40°	90,00



NOIR MAT



BLANC MAT

SWEET RD EVO



- Spot encastré rond fixe.
- Réflecteur basse luminance.
- 2700K, 3000K ou 4000K au choix via un interrupteur sur le convertisseur.
- Fixation par ressorts.
- Peut être recouvert par un isolant déroulé.
- Double bornier automatique.
- Convertisseur dimmable déporté fourni.
- Compatible avec variateur fin de phase.
- Bague couvrant un diamètre de perçage de 90 à 120mm à commander séparément.
- Driver ou source de remplacement disponibles séparément.

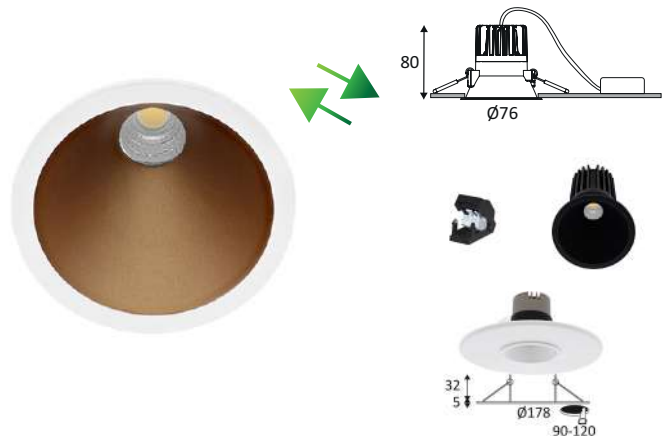

SWEET RD EVO	COULEUR	MATIÈRE	P	CCT	LED LUMEN	SYSTEM LUMEN	α	€
DO56405	■ NOIR MAT	POLYCARBONATE	7,5W	2700K 3000K 4000K	740Lm (4000K)	505Lm (4000K)	60°	50,00
DO56430	■ BLANC MAT	POLYCARBONATE	7,5W	2700K 3000K 4000K	740Lm (4000K)	575Lm (4000K)	60°	50,00
DO56449	■ BLANC MAT - CHAMPAGNE	POLYCARBONATE	7,5W	2700K 3000K 4000K	740Lm (4000K)	575Lm (4000K)	60°	50,00
DO56453	■ BLANC MAT - ARGENT	POLYCARBONATE	7,5W	2700K 3000K 4000K	740Lm (4000K)	575Lm (4000K)	60°	50,00
DO56481	■ BLANC MAT - NOIR	POLYCARBONATE	7,5W	2700K 3000K 4000K	740Lm (4000K)	505Lm (4000K)	60°	50,00

ACCESSOIRES	COULEUR	MATIÈRE	DESCRIPTION	€
DO33305	■ NOIR MAT	ALUMINIUM	BAGUE DE MONTAGE 178MM	18,00
DO33330	■ BLANC MAT	ALUMINIUM	BAGUE DE MONTAGE 178MM	18,00

CONVERTISSEURS ET SOURCES	LED	WATT MAX	€
CD562	DRIVER 5-7W 180MA CC DIM	5-7W	20,00
LP564	SOURCE LED 6W 740Lm 60°	6W	20,00



NOIR MAT



BLANC MAT

BLANC MAT -
CHAMPAGNEBLANC MAT -
ARGENT

BLANC MAT - NOIR

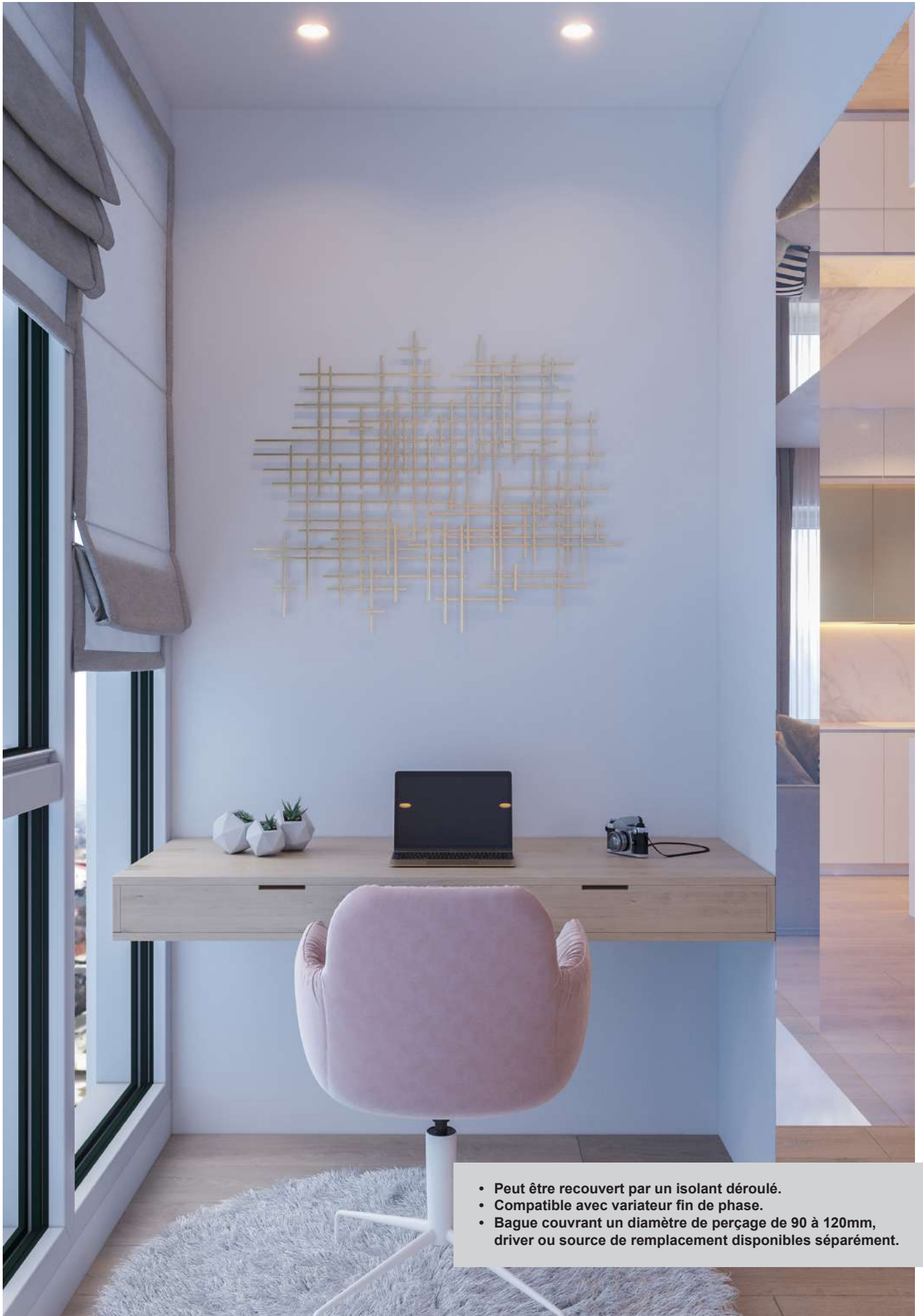
SWEET RD EVO

- Peut être recouvert par un isolant déroulé.
- Compatible avec variateur fin de phase.
- Bague couvrant un diamètre de perçage de 90 à 120mm, driver ou source de remplacement disponibles séparément.

SILK RDX



- Spot encastré rond orientable.
- Réflecteur basse luminance.
- Fixation par ressorts.
- Peut être recouvert par un isolant déroulé.
- Double bornier automatique.
- Convertisseur dimmable déporté fourni.
- Compatible avec variateur fin de phase.
- Bague couvrant un diamètre de perçage de 90 à 120mm à commander séparément.

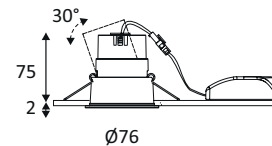

SILK RDX	COULEUR	MATIÈRE	P	CCT	LED LUMEN	SYSTEM LUMEN	α	€
DO501WW05	NOIR MAT	FONTE D'ALUMINIUM	6W	3000K	630Lm	490Lm	36°	65,00
DO501WW08	NOIR MAT - BRONZE SATINÉ	FONTE D'ALUMINIUM	6W	3000K	630Lm	490Lm	36°	65,00
DO501WW17	NOIR MAT - ARGENT	FONTE D'ALUMINIUM	6W	3000K	630Lm	490Lm	36°	65,00
DO501WW06	NOIR MAT - OR BROSSÉ	FONTE D'ALUMINIUM	6W	3000K	630Lm	490Lm	36°	65,00
DO501WW30	BLANC MAT	FONTE D'ALUMINIUM	6W	3000K	630Lm	510Lm	36°	65,00
DO501WW49	BLANC MAT - CHAMPAGNE	FONTE D'ALUMINIUM	6W	3000K	630Lm	510Lm	36°	65,00
DO501WW53	BLANC MAT - ARGENT	FONTE D'ALUMINIUM	6W	3000K	630Lm	510Lm	36°	65,00
DO501WW02	BLANC MAT - OR ROSE	FONTE D'ALUMINIUM	6W	3000K	630Lm	510Lm	36°	65,00

ACCESSOIRES	COULEUR	MATIÈRE	DESCRIPTION	€
DO33330	BLANC MAT	ALUMINIUM	BAGUE DE MONTAGE 178MM	18,00
DO33305	NOIR MAT	ALUMINIUM	BAGUE DE MONTAGE 178MM	18,00



NOIR MAT

NOIR MAT - BRONZE
SATINÉ

NOIR MAT - ARGENT

NOIR MAT - OR
BROSSÉ

BLANC MAT

BLANC MAT -
CHAMPAGNEBLANC MAT -
ARGENTBLANC MAT - OR
ROSE



AL3012 RD

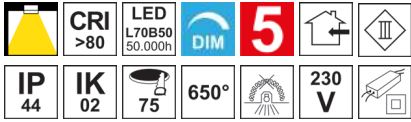

- Spot encastré rond fixe.
- Réflecteur basse luminance.
- Fixation par ressorts.
- Double bornier automatique.
- Convertisseur dimmable déporté fourni.
- Compatible avec variateur début et fin de phase.

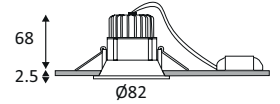

AL3012 RD	COULEUR	MATIÈRE	P	CCT	LED LUMEN	SYSTEM LUMEN	α	€
DO17105	■ NOIR MAT	FONTE D'ALUMINIUM	9W	3000K	1050Lm	820Lm	38°	75,00
DO17130	■ BLANC MAT	FONTE D'ALUMINIUM	9W	3000K	1050Lm	865Lm	38°	75,00
DO17144	■ BLANC MAT - DORÉ	FONTE D'ALUMINIUM	9W	3000K	1050Lm	865Lm	38°	75,00

DANS LA MÊME GAMME



NOIR MAT



BLANC MAT



BLANC MAT - DORÉ



AL3012 RD OUT PAGE 498

AL3012 RD WARM



- Spot encastré rond fixe.
- Réflecteur basse luminance.
- Fixation par ressorts.
- Double bornier automatique.
- Peut être recouvert par un isolant déroulé.
- Température de couleur variable de 1800K à 3000K suivant l'intensité de dimming.
- Convertisseur dimmable déporté fourni.
- Compatible avec variateur début et fin de phase.

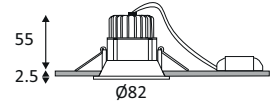

AL3012 RD WARM	COULEUR	MATIÈRE	P	CCT	LED LUMEN	SYSTEM LUMEN	α	€
DO33005	■ NOIR MAT	FONTE D'ALUMINIUM	6W	1800K>3000K	530Lm	405Lm	38°	100,00
DO33030	■ BLANC MAT	FONTE D'ALUMINIUM	6W	1800K>3000K	530Lm	425Lm	38°	100,00

DANS LA MÊME GAMME



NOIR MAT



BLANC MAT



AL3012 RD OUT PAGE 498

SYLA RD-B

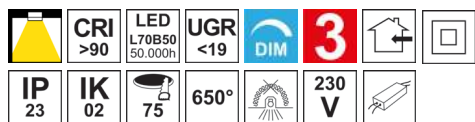

- Spot encastré rond fixe.
- Réflecteur basse luminance.
- Fixation par lamelles.
- Convertisseur dimmable déporté fourni.

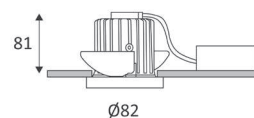

SYLA RD-B	COULEUR	MATIÈRE	P	CCT	LED LUMEN	SYSTEM LUMEN	α	€
DO221SW05	■ NOIR MAT	FONTE D'ALUMINIUM	10W	2700K	960Lm	775Lm	38°	88,00
DO221SW18	■ NOIR - DORÉ	FONTE D'ALUMINIUM	10W	2700K	960Lm	775Lm	38°	106,00
DO221SW30	■ BLANC MAT	FONTE D'ALUMINIUM	10W	2700K	960Lm	775Lm	38°	88,00
DO221WW05	■ NOIR MAT	FONTE D'ALUMINIUM	10W	3000K	1010Lm	850Lm	38°	88,00
DO221WW18	■ NOIR - DORÉ	FONTE D'ALUMINIUM	10W	3000K	1010Lm	850Lm	38°	106,00
DO221WW30	■ BLANC MAT	FONTE D'ALUMINIUM	10W	3000K	1010Lm	850Lm	38°	88,00

ACCESSOIRES	COULEUR	DESCRIPTION	L(MM)	€
DO33905	NOIR MAT	BAGUE CARREE 100X100MM	100	15,00
DO33930	BLANC MAT	BAGUE CARREE 100X100MM	100	15,00
DO34005	NOIR MAT	BAGUE RECTANGULAIRE 195X100MM	195	31,00
DO34030	BLANC MAT	BAGUE RECTANGULAIRE 195X100MM	195	31,00



NOIR MAT



NOIR - DORÉ



BLANC MAT

SYLA RD-B



ABY 1 RD



- Spot encastré rond fixe.
- Réflecteur basse luminance.
- Fixation par ressorts.
- Convertisseur dimmable déporté fourni.
- Compatible avec variateur début et fin de phase.

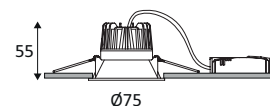

ABY 1 RD	COULEUR	MATIÈRE	P	CCT	LED LUMEN	SYSTEM LUMEN	α	€
DO461WW05	■ NOIR MAT	FONTE D'ALUMINIUM	6,5W	3000K	550Lm	520Lm	36°	65,00
DO461WW30	■ BLANC MAT	FONTE D'ALUMINIUM	6,5W	3000K	550Lm	520Lm	36°	65,00



NOIR MAT



BLANC MAT

ABY 2 RD



- Spot encastré rond fixe.
- Réflecteur basse luminance.
- Fixation par ressorts.
- Convertisseur dimmable déporté fourni.
- Compatible avec variateur début et fin de phase.

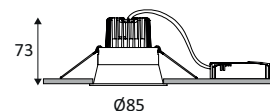

ABY 2 RD	COULEUR	MATIÈRE	P	CCT	LED LUMEN	SYSTEM LUMEN	α	€
DO462WW05	■ NOIR MAT	FONTE D'ALUMINIUM	9W	3000K	750Lm	680Lm	36°	75,00
DO462WW30	■ BLANC MAT	FONTE D'ALUMINIUM	9W	3000K	750Lm	680Lm	36°	75,00



NOIR MAT



BLANC MAT



ABY 3 RD

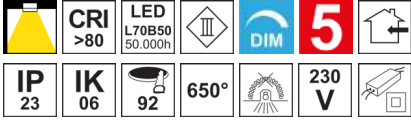

- Spot encastré rond fixe.
- Réflecteur basse luminance.
- Fixation par ressorts.
- Convertisseur dimmable déporté fourni.
- Compatible avec variateur début et fin de phase.

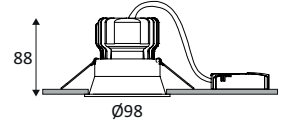

ABY 3 RD	COULEUR	MATIÈRE	P	CCT	LED LUMEN	SYSTEM LUMEN	α	€
DO464WW05	■ NOIR MAT	FRONT D'ALUMINIUM	15W	3000K	1300Lm	1150Lm	45°	95,00
DO464WW30	■ BLANC MAT	FRONT D'ALUMINIUM	15W	3000K	1300Lm	1150Lm	45°	95,00



NOIR MAT



BLANC MAT

ABY 2 RD



ALLY 3 RDX



- Spot encastré rond orientable.
- Fixation par ressorts.
- Convertisseur dimmable déporté fourni.
- Compatible avec variateur début et fin de phase.
- En option, convertisseur dimmable DALI-PUSH CD123 à commander séparément.

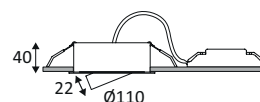

ALLY 3 RDX	COULEUR	MATIÈRE	P	CCT	LED LUMEN	SYSTEM LUMEN	α	€
DO529WW05	■ NOIR MAT	ALUMINIUM	10W	3000K	1025Lm	715Lm	38°	128,00
DO529WW30	■ BLANC MAT	ALUMINIUM	10W	3000K	1025Lm	715Lm	38°	128,00

CONVERTISSEURS ET SOURCES		WATT MAX	€
CD123	DRIVER 3-18W 250MA CC DIM DALI	3-18W	80,00

DANS LA MÊME GAMME



ALLY 1 RDX PAGE 94



NOIR MAT



BLANC MAT

ALLY 4 RDX

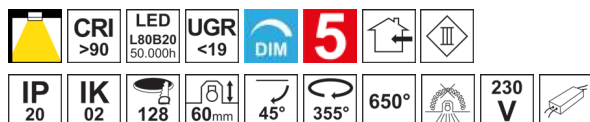

- Spot encastré rond orientable.
- Fixation par ressorts.
- Convertisseur dimmable déporté fourni.
- Compatible avec variateur début et fin de phase.
- En option, convertisseur dimmable DALI-PUSH CD140 à commander séparément.

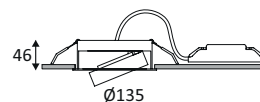

ALLY 4 RDX	COULEUR	MATIÈRE	P	CCT	LED LUMEN	SYSTEM LUMEN	α	€
DO530WW05	■ NOIR MAT	ALUMINIUM	14W	3000K	1270Lm	925Lm	38°	147,00
DO530WW30	■ BLANC MAT	ALUMINIUM	14W	3000K	1270Lm	925Lm	38°	147,00

CONVERTISSEURS ET SOURCES		WATT MAX	€
CD140	DRIVER 3-18W 350MA CC DIM DALI	3-18W	90,00

DANS LA MÊME GAMME



ALLY 2 RDX PAGE 94



NOIR MAT



BLANC MAT



DOTS

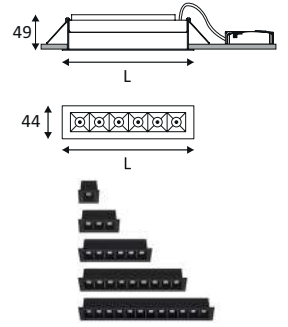

- Spot encastré pour éclairage d'accentuation.
- Réflecteur basse luminance.
- Fixation par ressorts.
- Convertisseur dimmable déporté fourni.
- DO497, DO498 et DO499 en version DALI : convertisseur avec fonction push-dim.

DOTS		COULEUR	MATIÈRE	P	CCT	L(MM)	LED LUMEN	SYSTEM LUMEN	α	€	
DIMMABLE COUPURE DE PHASE											
		DO500WW05	NOIR MAT	ALUMINIUM	3W	3000K	48	320Lm	150Lm	45°	45,00
		DO500WW30	BLANC MAT	ALUMINIUM	3W	3000K	48	320Lm	150Lm	45°	45,00
		DO496WW05	NOIR MAT	ALUMINIUM	6W	3000K	102	470Lm	345Lm	45°	55,00
		DO496WW30	BLANC MAT	ALUMINIUM	6W	3000K	102	470Lm	345Lm	45°	55,00
		DO497WW05	NOIR MAT	ALUMINIUM	12W	3000K	182	940Lm	610Lm	45°	80,00
		DO497WW30	BLANC MAT	ALUMINIUM	12W	3000K	182	940Lm	610Lm	45°	80,00
		DO498WW05	NOIR MAT	ALUMINIUM	16W	3000K	262	1400Lm	1010Lm	45°	105,00
		DO498WW30	BLANC MAT	ALUMINIUM	16W	3000K	262	1400Lm	1010Lm	45°	105,00
		DO499WW05	NOIR MAT	ALUMINIUM	20W	3000K	342	1880Lm	1215Lm	45°	120,00
		DO499WW30	BLANC MAT	ALUMINIUM	20W	3000K	342	1880Lm	1215Lm	45°	120,00
DIMMABLE DALI											
		DO500WW05DA	NOIR MAT	ALUMINIUM	3W	3000K	48	320Lm	150Lm	45°	95,00
		DO500WW30DA	BLANC MAT	ALUMINIUM	3W	3000K	48	320Lm	150Lm	45°	95,00
		DO496WW05DA	NOIR MAT	ALUMINIUM	6W	3000K	102	470Lm	345Lm	45°	105,00
		DO496WW30DA	BLANC MAT	ALUMINIUM	6W	3000K	102	470Lm	345Lm	45°	105,00
		DO497WW05DA	NOIR MAT	ALUMINIUM	12W	3000K	182	940Lm	610Lm	45°	130,00
		DO497WW30DA	BLANC MAT	ALUMINIUM	12W	3000K	182	940Lm	610Lm	45°	130,00
		DO498WW05DA	NOIR MAT	ALUMINIUM	16W	3000K	262	1400Lm	1010Lm	45°	155,00
		DO498WW30DA	BLANC MAT	ALUMINIUM	16W	3000K	262	1400Lm	1010Lm	45°	155,00
		DO499WW05DA	NOIR MAT	ALUMINIUM	20W	3000K	342	1880Lm	1215Lm	45°	170,00
		DO499WW30DA	BLANC MAT	ALUMINIUM	20W	3000K	342	1880Lm	1215Lm	45°	170,00

DANS LA MÊME GAMME



NOIR MAT

BLANC MAT



DOTS C PAGE 222

SEMI-ENCASTRÉS

SIRA R

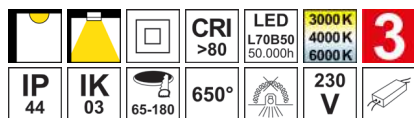

- Downlight rond fixe 3 en 1.
- Montage apparent ou semi-encastré.
- 3000K, 4000K ou 6000K au choix via un interrupteur à l'arrière du luminaire.
- Fixation par ressorts ajustables pour couvrir les diamètres d'encastrement de 65 à 180mm.
- Convertisseur non dimmable intégré dans l'appareil.

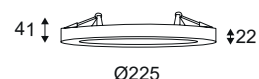

SIRA R	COULEUR	MATIÈRE	P	CCT	LED LUMEN	SYSTEM LUMEN	α	€
DO36630	BLANC MAT	COMPOSITE	18W	3000K 4000K 6000K	2150Lm (4000K)	1600Lm (4000K)	110°	52,00

SIRA R SENSOR IR



- Downlight rond fixe 3 en 1.
- Montage apparent ou semi-encastré.
- Multi-puissance : 12, 15 ou 18W au choix via un interrupteur à l'arrière du luminaire.
- 3000K, 4000K ou 6000K au choix via un interrupteur à l'arrière du luminaire.
- Avec détecteur IR 120°, zone de détection 3m de diamètre.
- Fixation par ressorts ajustables pour couvrir les diamètres d'encastrement de 65 à 180mm.
- Convertisseur non dimmable intégré dans l'appareil.

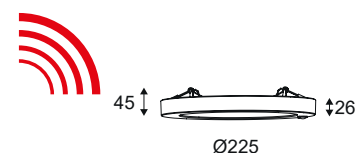

SIRA R SENSOR IR	COULEUR	MATIÈRE	LED	CCT	LED LUMEN	SYSTEM LUMEN	α	€
DO49530	BLANC MAT	COMPOSITE	12W 15W 18W	3000K 4000K 6000K	1550Lm (4000K) 1910Lm (4000K) 2150Lm (4000K)	1190Lm (4000K) 1470Lm (4000K) 1660Lm (4000K)	110°	90,00

SIRA R SENSOR IR

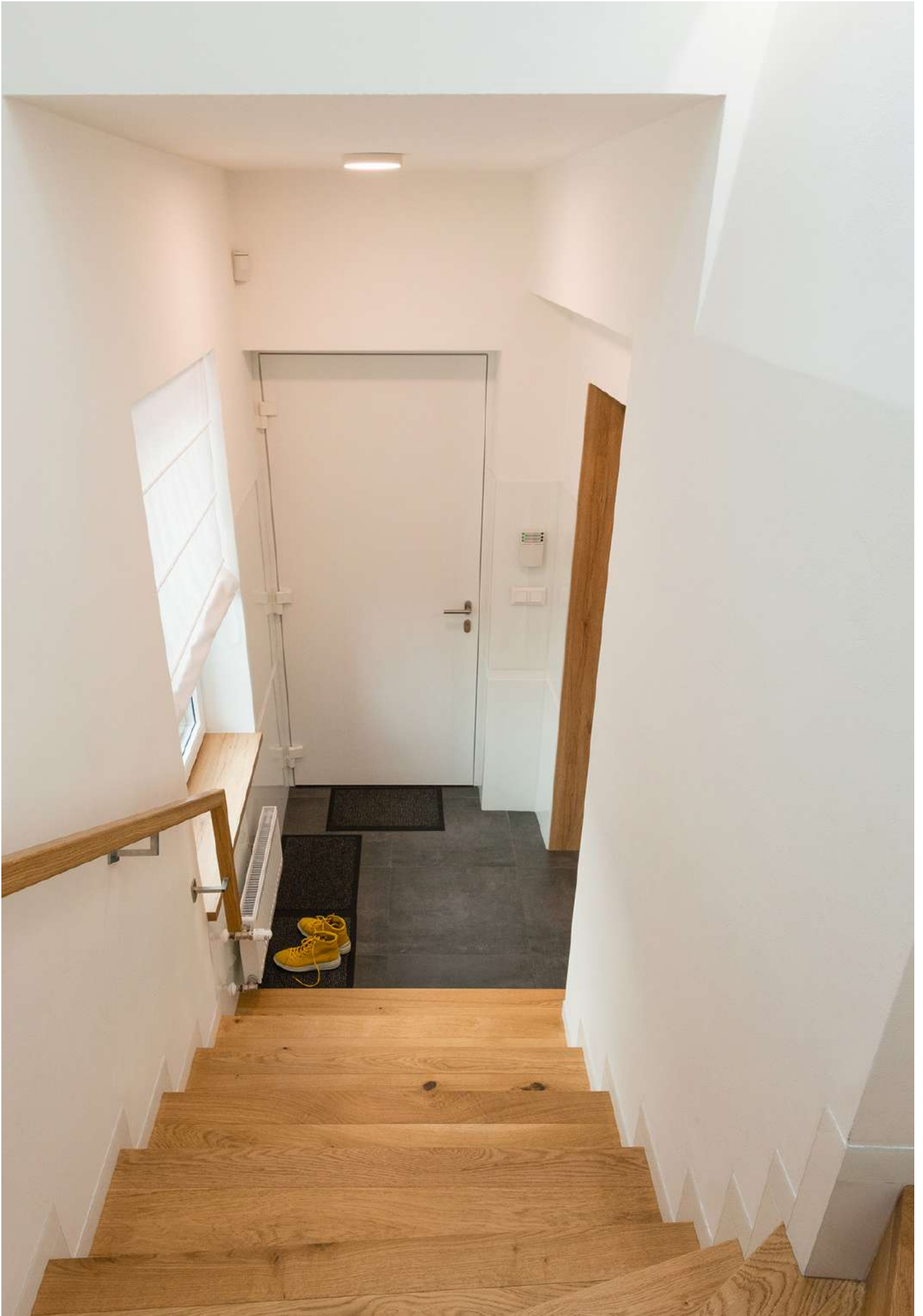

FILI 1 RX GU10 AUTO

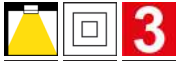

- Spot semi-encastré rond orientable.
- Fixation par ressorts.
- Double bornier automatique.

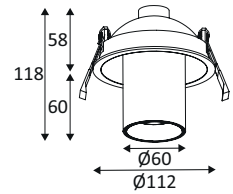

FILI 1 RX GU10 AUTO	COULEUR	MATIÈRE	DOUILLE	LAMPE	WATT MAX	€
DO44405	■ NOIR MAT	ALUMINIUM	GU10	PAR16 LED	10W	63,00
DO44430	■ BLANC MAT	ALUMINIUM	GU10	PAR16 LED	10W	63,00

DANS LA MÊME GAMME



NOIR MAT



BLANC MAT



FILI 1 RX-B PAGE 92

FILI 5 RX-B GU10 AUTO

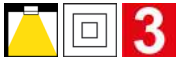

- Spot semi-encastré rond orientable.
- Fixation par lamelles.
- Livré avec réflecteur doré.
- Double bornier automatique.

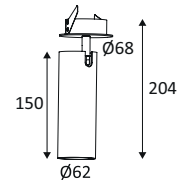

FILI 5 RX-B GU10 AUTO	COULEUR	MATIÈRE	DOUILLE	LAMPE	WATT MAX	€
DO49105	■ NOIR MAT	ALUMINIUM	GU10	PAR16 LED	10W	74,00
DO49130	■ BLANC MAT	ALUMINIUM	GU10	PAR16 LED	10W	74,00

DANS LA MÊME GAMME



NOIR MAT



BLANC MAT



FILI 5 RDX-B PAGE 90



FILI 5 RX-B GU10 AUTO



FILI 1 RX-B



- Spot semi-encastré rond orientable.
- Fixation par lamelles.
- Convertisseur non dimmable déporté fourni.
- En option, convertisseur dimmable DALI-PUSH CD123 à commander séparément.

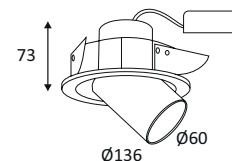

FILI 1 RX-B	COULEUR	MATIÈRE	P	CCT	LED LUMEN	SYSTEM LUMEN	α	€
DO246WW05	■ NOIR MAT	ALUMINIUM	10W	3000K	1010Lm	650Lm	40°	170,00
DO246WW30	■ BLANC MAT	ALUMINIUM	10W	3000K	1010Lm	650Lm	40°	170,00
CONVERTISSEURS ET SOURCES			WATT MAX	€	DANS LA MÊME GAMME			
CD123	DRIVER 3-18W 250MA CC DIM DALI		3-18W	80,00		FILI 1 RX GU10 AUTO PAGE 90		



NOIR MAT



BLANC MAT

FILI 5 RDX-B



- Spot semi-encastré rond orientable.
- Fixation par lamelles.
- Livré avec réflecteur doré.
- Double bornier automatique.
- Convertisseur dimmable déporté fourni.
- Compatible avec variateur fin de phase.
- En option, convertisseur dimmable DALI-PUSH CD140 à commander séparément.

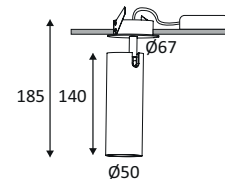

FILI 5 RDX-B	COULEUR	MATIÈRE	P	CCT	LED LUMEN	SYSTEM LUMEN	α	€
DO490WW05	■ NOIR MAT	ALUMINIUM	14W	3000K	1120Lm	505Lm	40°	130,00
DO490WW30	■ BLANC MAT	ALUMINIUM	14W	3000K	1120Lm	505Lm	40°	130,00
CONVERTISSEURS ET SOURCES			WATT MAX	€	DANS LA MÊME GAMME			
CD140	DRIVER 3-18W 350MA CC DIM DALI		3-18W	90,00		FILI 5 RX-B GU10 AUTO PAGE 90		



NOIR MAT



BLANC MAT



FILI 1 RX-B



ALLY 1 RDX

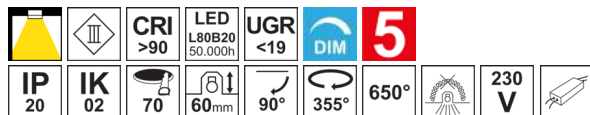

- Spot semi-encastré rond orientable.
- Fixation par ressorts.
- Convertisseur dimmable déporté fourni.
- Compatible avec variateur début et fin de phase.
- En option, convertisseur dimmable DALI-PUSH CD123 à commander séparément.

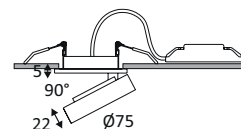

ALLY 1 RDX	COULEUR	MATIÈRE	P	CCT	LED LUMEN	SYSTEM LUMEN	α	€
DO527WW05	■ NOIR MAT	ALUMINIUM	10W	3000K	1025Lm	715Lm	38°	124,00
DO527WW30	■ BLANC MAT	ALUMINIUM	10W	3000K	1025Lm	715Lm	38°	124,00
CONVERTISSEURS ET SOURCES			WATT MAX	€	DANS LA MÊME GAMME			
CD123	DRIVER 3-18W 250MA CC DIM DALI		3-18W	80,00		ALLY 3 RDX PAGE 84		



NOIR MAT



BLANC MAT

ALLY 2 RDX



- Spot semi-encastré rond orientable.
- Fixation par ressorts.
- Convertisseur dimmable déporté fourni.
- Compatible avec variateur début et fin de phase.
- En option, convertisseur dimmable DALI-PUSH CD140 à commander séparément.

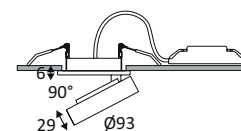

ALLY 2 RDX	COULEUR	MATIÈRE	P	CCT	LED LUMEN	SYSTEM LUMEN	α	€
DO528WW05	■ NOIR MAT	ALUMINIUM	14W	3000K	1270Lm	925Lm	38°	140,00
DO528WW30	■ BLANC MAT	ALUMINIUM	14W	3000K	1270Lm	925Lm	38°	140,00
CONVERTISSEURS ET SOURCES			WATT MAX	€	DANS LA MÊME GAMME			
CD140	DRIVER 3-18W 350MA CC DIM DALI		3-18W	90,00		ALLY 4 RDX PAGE 84		



NOIR MAT



BLANC MAT



ALLY 1 RDX

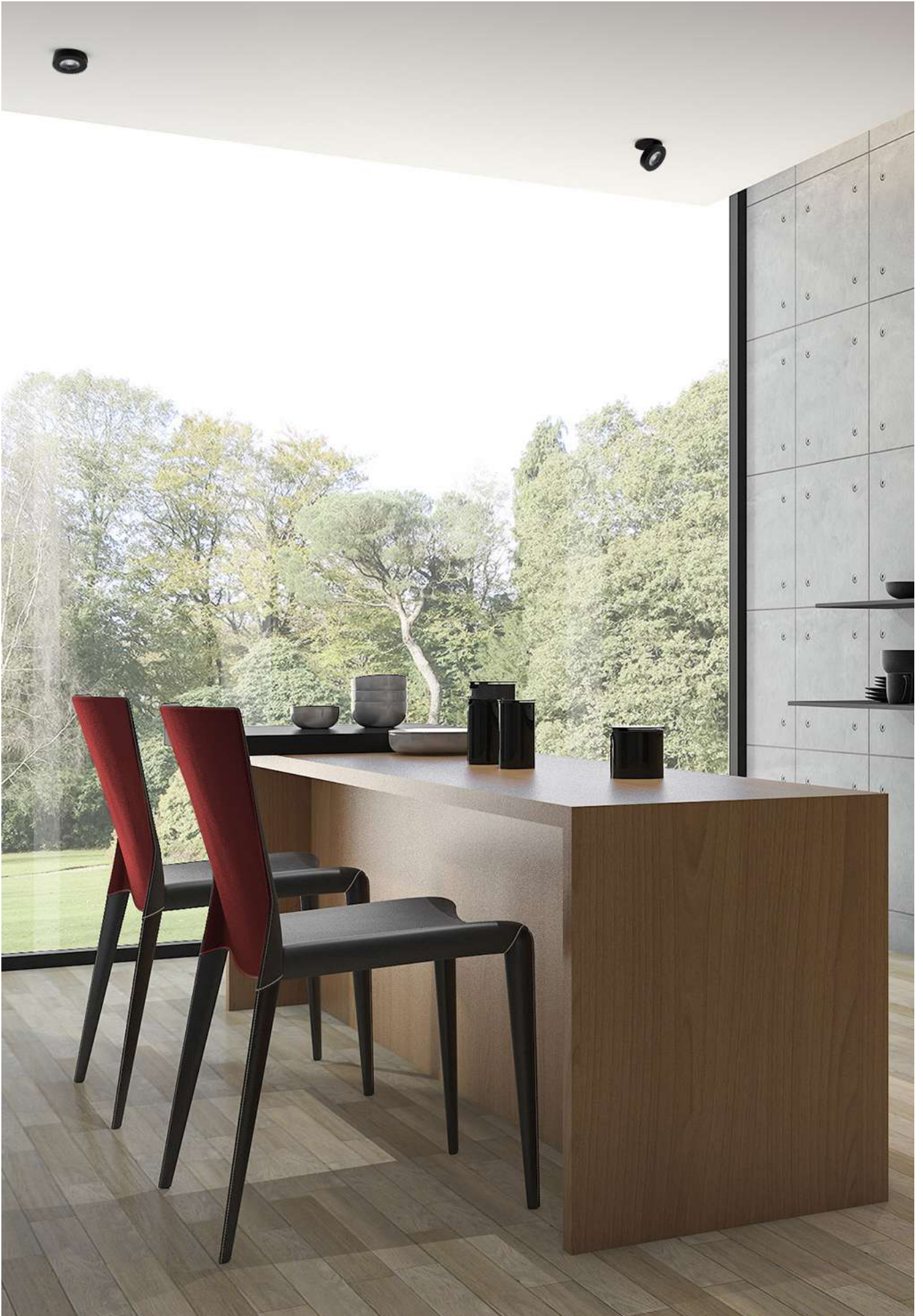

CLIC RDX MINI

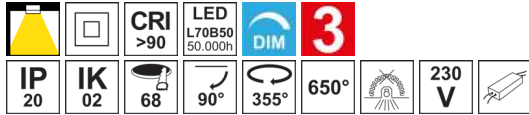

- Spot semi-encastré rond orientable.
- Fixation par ressorts.
- Convertisseur dimmable déporté fourni.
- Compatible avec variateur fin de phase.

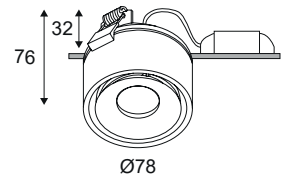

CLIC RDX MINI	COULEUR	MATIÈRE	P	CCT	LED LUMEN	SYSTEM LUMEN	α	€
DO365SW05	NOIR MAT	ALUMINIUM	8W	2700K	710Lm	435Lm	38°	128,00
DO365SW30	BLANC MAT	ALUMINIUM	9W	2700K	920Lm	560Lm	38°	128,00
DO365WW05	NOIR MAT	ALUMINIUM	9W	3000K	930Lm	630Lm	38°	128,00
DO365WW30	BLANC MAT	ALUMINIUM	9W	3000K	930Lm	680Lm	38°	128,00

DANS LA MÊME GAMME



NOIR MAT



BLANC MAT



CLAC 1 MINI PAGE 206



CLAC 2 MINI PAGE 206

CLIC RDX

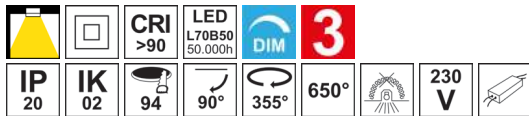

- Spot semi-encastré rond orientable.
- Fixation par ressorts.
- Convertisseur dimmable déporté fourni.
- Compatible avec variateur fin de phase.
- En option, convertisseur dimmable DALI-PUSH CD124 à commander séparément.

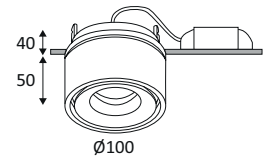

CLIC RDX	COULEUR	MATIÈRE	P	CCT	LED LUMEN	SYSTEM LUMEN	α	€
DO224SW05	NOIR MAT	ALUMINIUM	13W	2700K	1120Lm	800Lm	38°	185,00
DO224SW30	BLANC MAT	ALUMINIUM	13W	2700K	1120Lm	800Lm	38°	185,00
DO224WW05	NOIR MAT	ALUMINIUM	13W	3000K	1570Lm	905Lm	38°	185,00
DO224WW30	BLANC MAT	ALUMINIUM	13W	3000K	1570Lm	1020Lm	38°	185,00

CONVERTISSEURS ET SOURCES

WATT MAX

€

DANS LA MÊME GAMME

CD124 DRIVER 3-18W 300MA CC DIM DALI



3-18W

92,00



CLAC PAGE 207



NOIR MAT



BLANC MAT

CLIC RDX MINI



CLIC RDX



OLYN 1 RDX

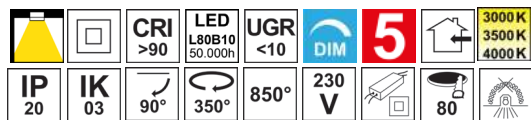

- Spot semi-encastré rond orientable.
- 3000K, 3500K ou 4000K au choix via un interrupteur à l'arrière du luminaire.
- Fixation par ressorts.
- Convertisseur dimmable par coupure de phase déporté fourni.
- Très basse luminance grâce à un design d'optique à réflexion totale interne.

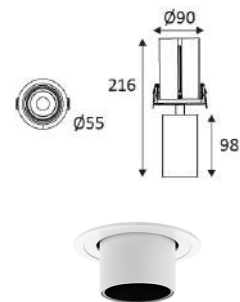

OLYN 1 RDX	COULEUR	MATIÈRE	P	CCT	LED LUMEN	SYSTEM LUMEN	α	€
DO57105 NEW	NOIR MAT	ALUMINIUM	15W	3000K 3500K 4000K	1820Lm (4000K)	1340Lm (4000K)	36°	170,00
DO57130 NEW	BLANC MAT	ALUMINIUM	15W	3000K 3500K 4000K	1820Lm (4000K)	1340Lm (4000K)	36°	170,00
DO57131 NEW	NOIR MAT - BRONZE SATINÉ	ALUMINIUM	15W	3000K 3500K 4000K	1820Lm (4000K)	1340Lm (4000K)	36°	190,00
DO57151 NEW	BLANC MAT - ROSE BROSSÉ	ALUMINIUM	15W	3000K 3500K 4000K	1820Lm (4000K)	1340Lm (4000K)	36°	190,00
DO57156 NEW	BLANC MAT - NICKEL BROSSÉ	ALUMINIUM	15W	3000K 3500K 4000K	1820Lm (4000K)	1340Lm (4000K)	36°	190,00
DO57157 NEW	NOIR MAT - NICKEL BROSSÉ	ALUMINIUM	15W	3000K 3500K 4000K	1820Lm (4000K)	1340Lm (4000K)	36°	190,00
DO57159 NEW	BLANC MAT - OR BROSSÉ	ALUMINIUM	15W	3000K 3500K 4000K	1820Lm (4000K)	1340Lm (4000K)	36°	190,00
DO57165 NEW	BLANC MAT - BRONZE SATINÉ	ALUMINIUM	15W	3000K 3500K 4000K	1820Lm (4000K)	1340Lm (4000K)	36°	190,00
DO57167 NEW	NOIR MAT - ROSE BROSSÉ	ALUMINIUM	15W	3000K 3500K 4000K	1820Lm (4000K)	1340Lm (4000K)	36°	190,00
DO57168 NEW	NOIR MAT - OR BROSSÉ	ALUMINIUM	15W	3000K 3500K 4000K	1820Lm (4000K)	1340Lm (4000K)	36°	190,00



DANS LA MÊME GAMME



OLYN 1 W PAGE 168



OLYN 2 RDX PAGE 99



OLYN 3 T PAGE 280



OLYN 2 C PAGE 204



OLYN 2 P PAGE 229



OLYN 1 P PAGE 228



OLYN 2 RDX

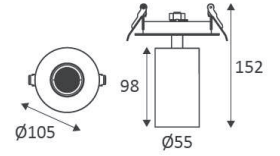

- Spot semi-encastré rond orientable.
- 3000K, 3500K ou 4000K au choix via un interrupteur à l'arrière du luminaire.
- Fixation par ressorts.
- Convertisseur dimmable par coupure de phase déporté fourni.
- Très basse luminance grâce à un design d'optique à réflexion totale interne.

OLYN 2 RDX	COULEUR	MATIÈRE	P	CCT	LED LUMEN	SYSTEM LUMEN	α	€
DO57205 NEW	NOIR MAT	ALUMINIUM	15W	3000K 3500K 4000K	1820Lm (4000K)	1340Lm (4000K)	36°	150,00
DO57230 NEW	BLANC MAT	ALUMINIUM	15W	3000K 3500K 4000K	1820Lm (4000K)	1340Lm (4000K)	36°	150,00
DO57231 NEW	NOIR MAT - BRONZE SATINÉ	ALUMINIUM	15W	3000K 3500K 4000K	1820Lm (4000K)	1340Lm (4000K)	36°	170,00
DO57251 NEW	BLANC MAT - ROSE BROSSÉ	ALUMINIUM	15W	3000K 3500K 4000K	1820Lm (4000K)	1340Lm (4000K)	36°	170,00
DO57256 NEW	BLANC MAT - NICKEL BROSSÉ	ALUMINIUM	15W	3000K 3500K 4000K	1820Lm (4000K)	1340Lm (4000K)	36°	170,00
DO57257 NEW	NOIR MAT - NICKEL BROSSÉ	ALUMINIUM	15W	3000K 3500K 4000K	1820Lm (4000K)	1340Lm (4000K)	36°	170,00
DO57259 NEW	BLANC MAT - OR BROSSÉ	ALUMINIUM	15W	3000K 3500K 4000K	1820Lm (4000K)	1340Lm (4000K)	36°	170,00
DO57265 NEW	BLANC MAT - BRONZE SATINÉ	ALUMINIUM	15W	3000K 3500K 4000K	1820Lm (4000K)	1340Lm (4000K)	36°	170,00
DO57267 NEW	NOIR MAT - ROSE BROSSÉ	ALUMINIUM	15W	3000K 3500K 4000K	1820Lm (4000K)	1340Lm (4000K)	36°	170,00
DO57268 NEW	NOIR MAT - OR BROSSÉ	ALUMINIUM	15W	3000K 3500K 4000K	1820Lm (4000K)	1340Lm (4000K)	36°	170,00



NOIR MAT



BLANC MAT

NOIR MAT -
BRONZE SATINÉBLANC MAT -
ROSE BROSSÉBLANC MAT -
NICKEL BROSSÉNOIR MAT -
NICKEL BROSSÉBLANC MAT -
OR BROSSÉBLANC MAT -
BRONZE SATINÉNOIR MAT -
ROSE BROSSÉNOIR MAT -
OR BROSSÉ

DANS LA MÊME GAMME



OLYN 1 W PAGE 168



OLYN 3 T PAGE 280



OLYN 2 C PAGE 204



OLYN 2 P PAGE 229



OLYN 1 RDX PAGE 98

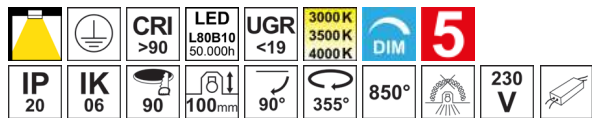

OLYN 1 P PAGE 228

KARL 1 RDX

- Spot semi-encastré rond orientable 3 en 1.
- 3000K, 3500K ou 4000K au choix via un interrupteur à l'arrière du luminaire.
- Fixation par ressorts.
- Convertisseur dimmable déporté fourni.
- Compatible avec variateur fin de phase.

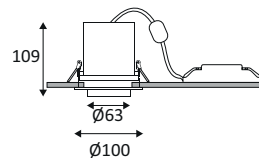

KARL 1 RDX	COULEUR	MATIÈRE	P	CCT	LED LUMEN	SYSTEM LUMEN	α	€
DO54205	■ NOIR MAT	ALUMINIUM	13W	3000K 3500K 4000K	1330Lm (4000K)	960Lm (4000K)	38°	125,00
DO54230	□ BLANC MAT	ALUMINIUM	13W	3000K 3500K 4000K	1330Lm (4000K)	960Lm (4000K)	38°	125,00



NOIR MAT

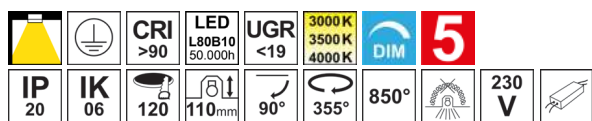

BLANC MAT

KARL 2 RDX

- Spot semi-encastré rond orientable 3 en 1.
- 3000K, 3500K ou 4000K au choix via un interrupteur à l'arrière du luminaire.
- Fixation par ressorts.
- Convertisseur dimmable déporté fourni.
- Compatible avec variateur fin de phase.

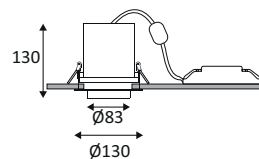

KARL 2 RDX	COULEUR	MATIÈRE	P	CCT	LED LUMEN	SYSTEM LUMEN	α	€
DO54305	■ NOIR MAT	ALUMINIUM	26W	3000K 3500K 4000K	2750Lm (4000K)	2250Lm (4000K)	38°	164,00
DO54330	□ BLANC MAT	ALUMINIUM	26W	3000K 3500K 4000K	2750Lm (4000K)	2250Lm (4000K)	38°	164,00



NOIR MAT



BLANC MAT



KARL 1 RDX

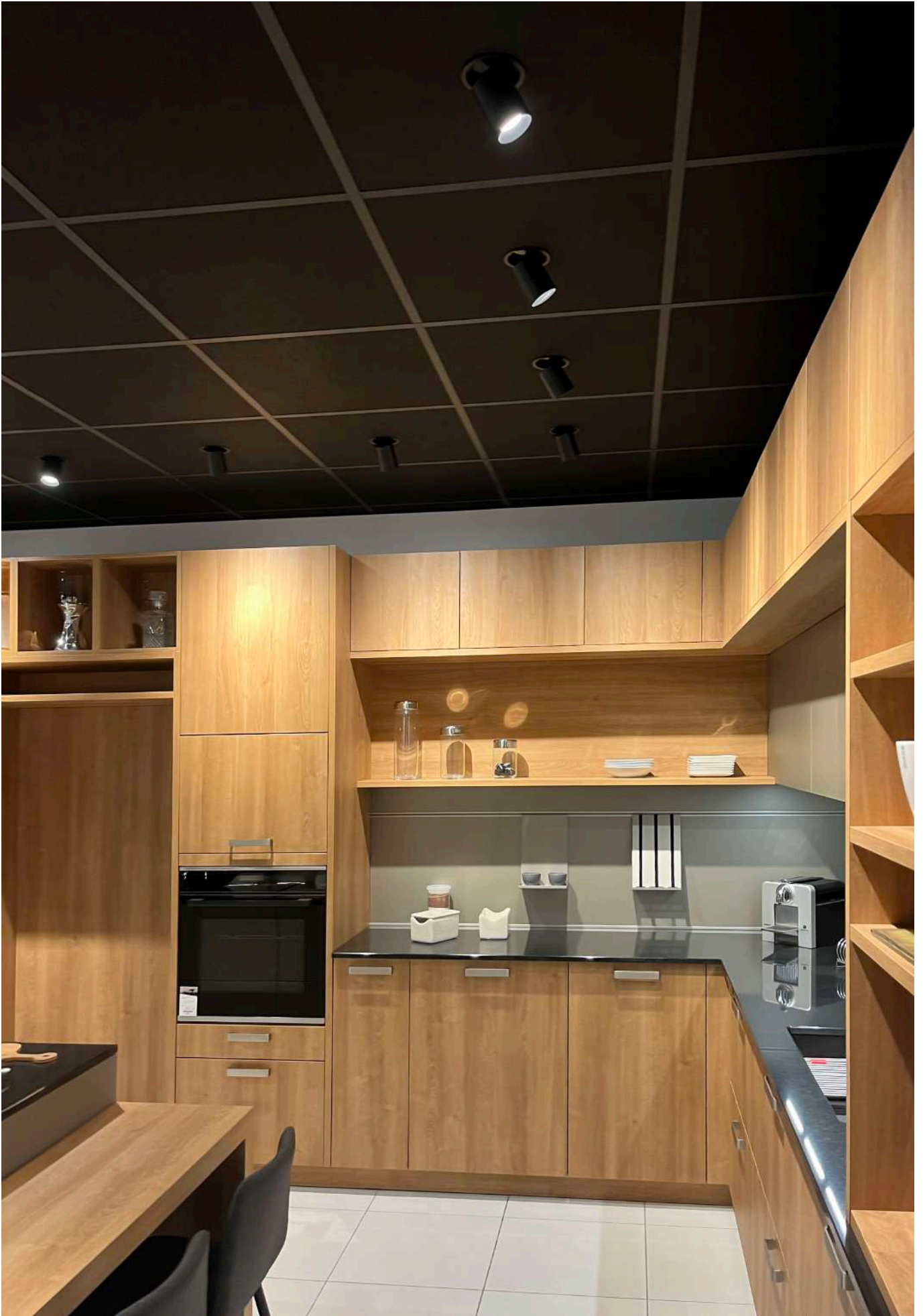

OBIA 1 RX

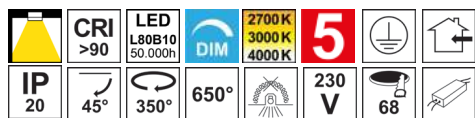

- Spot semi-encastré rond orientable.
- Fixation par ressorts.
- Tête inclinable jusqu'à 45°.
- CCT (2700K, 3000K ou 4000K) et puissance (6 ou 9W) au choix via un interrupteur dans le luminaire.
- Convertisseur dimmable par coupure de phase intégré dans le luminaire.

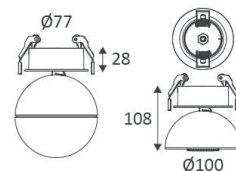

OBIA 1 RX	COULEUR	MATIÈRE	P	CCT	LED LUMEN	SYSTEM LUMEN	α	€
DO58105 NEW	NOIR MAT	FONTE D'ALUMINIUM	6-9W	2700K 3000K 4000K	950Lm (4000K)	710Lm (4000K)	150°	190,00
DO58130 NEW	BLANC MAT	FONTE D'ALUMINIUM	6-9W	2700K 3000K 4000K	950Lm (4000K)	710Lm (4000K)	150°	190,00



NOIR MAT



BLANC MAT

OBIA 2 RX

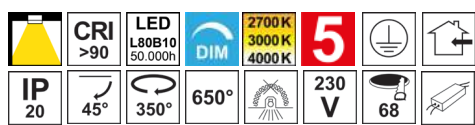

- Spot semi-encastré rond orientable.
- Fixation par ressorts.
- Tête inclinable jusqu'à 45°.
- CCT (2700K, 3000K ou 4000K) et puissance (6 ou 9W) au choix via un interrupteur dans le luminaire.
- Convertisseur dimmable par coupure de phase intégré dans le luminaire.

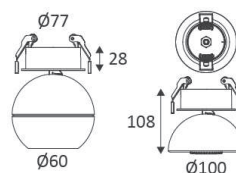

OBIA 2 RX	COULEUR	MATIÈRE	P	CCT	LED LUMEN	SYSTEM LUMEN	α	€
DO58205 NEW	NOIR MAT	FONTE D'ALUMINIUM	6-9W	2700K 3000K 4000K	950Lm (4000K)	755Lm (4000K)	60°	200,00
DO58208 NEW	NOIR MAT - CHAMPAGNE	FONTE D'ALUMINIUM	6-9W	2700K 3000K 4000K	950Lm (4000K)	755Lm (4000K)	60°	210,00
DO58230 NEW	BLANC MAT	FONTE D'ALUMINIUM	6-9W	2700K 3000K 4000K	950Lm (4000K)	755Lm (4000K)	60°	200,00
DO58235 NEW	NOIR MAT - BLANC MAT	FONTE D'ALUMINIUM	6-9W	2700K 3000K 4000K	950Lm (4000K)	755Lm (4000K)	60°	210,00
DO58249 NEW	BLANC MAT - CHAMPAGNE	FONTE D'ALUMINIUM	6-9W	2700K 3000K 4000K	950Lm (4000K)	755Lm (4000K)	60°	210,00
DO58281 NEW	BLANC MAT - NOIR	FONTE D'ALUMINIUM	6-9W	2700K 3000K 4000K	950Lm (4000K)	755Lm (4000K)	60°	210,00



NOIR MAT

NOIR MAT -
CHAMPAGNENOIR MAT -
BLANC MAT

BLANC MAT

BLANC MAT -
CHAMPAGNEBLANC MAT -
NOIR



OBIA 2 RX

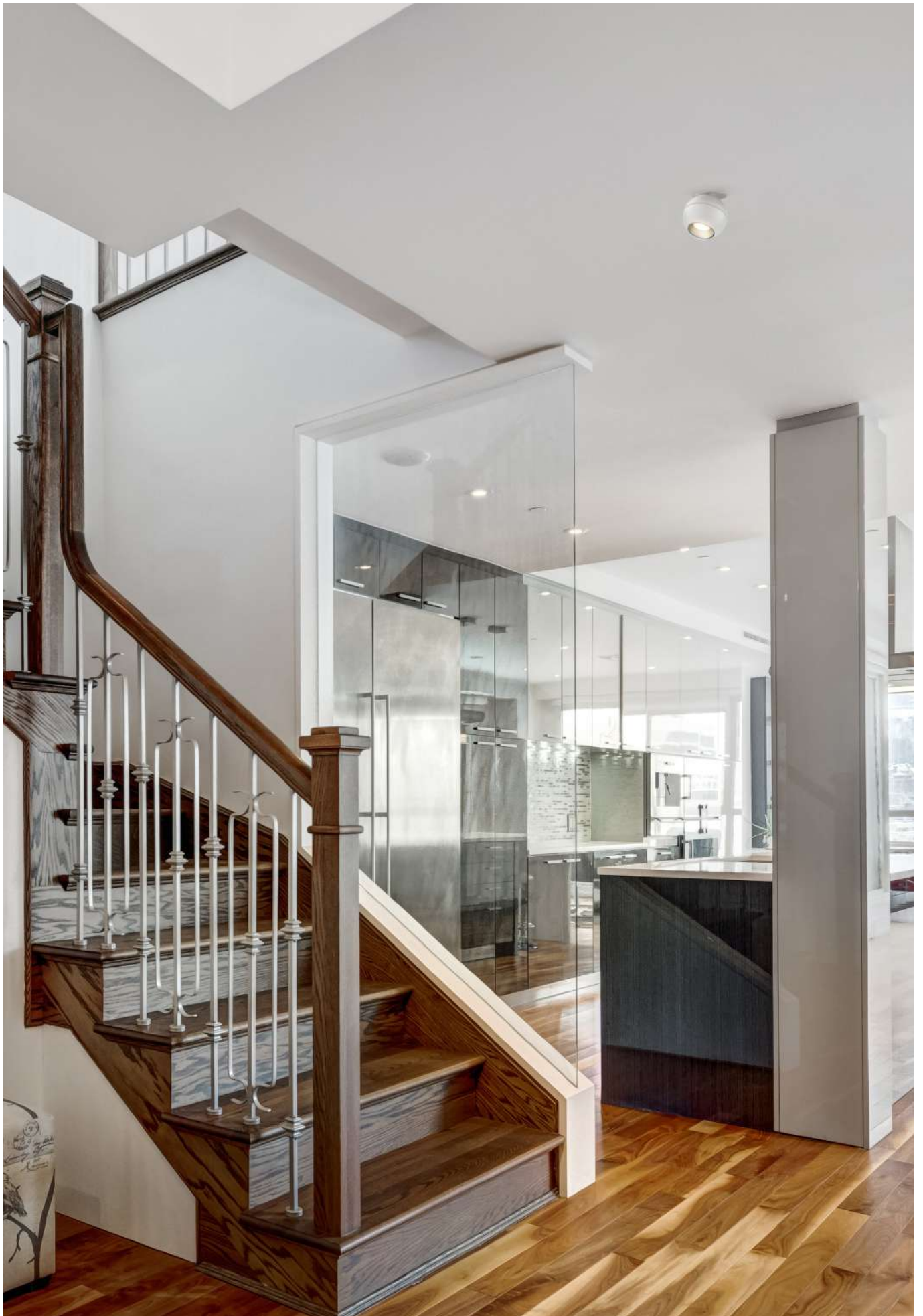

RETI 1 RX

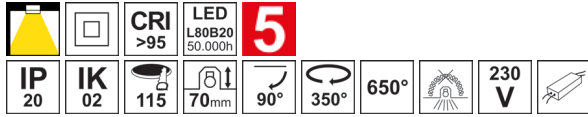

- Downlight semi-encastré rond orientable.
- Faisceau lumineux précisément dessiné grâce à une lentille en verre de haute qualité.
- Fixation par ressorts.
- Convertisseur non dimmable déporté fourni.

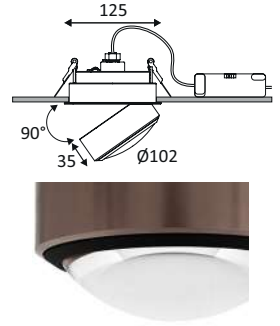

RETI 1 RX	COULEUR	MATIÈRE	P	CCT	LED LUMEN	SYSTEM LUMEN	α	€
DO560WW05	■ NOIR MAT	ALUMINIUM	18W	3000K	1620Lm	1490Lm	80°	245,00
DO560WW31	■ NOIR MAT - BRONZE SATINÉ	ALUMINIUM	18W	3000K	1620Lm	1490Lm	80°	245,00
DO560WW30	■ BLANC MAT	ALUMINIUM	18W	3000K	1620Lm	1490Lm	80°	245,00

DANS LA MÊME GAMME



NOIR MAT

NOIR MAT - BRONZE SATINÉ

BLANC MAT



RETI W PAGE 170



RETI P PAGE 236

RETI 2 RX

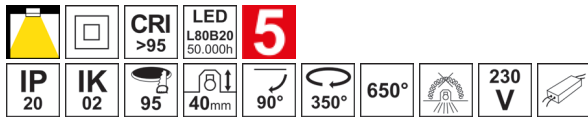

- Downlight semi-encastré rond orientable.
- Faisceau lumineux précisément dessiné grâce à une lentille en verre de haute qualité.
- Fixation par ressorts.
- Convertisseur non dimmable déporté fourni.

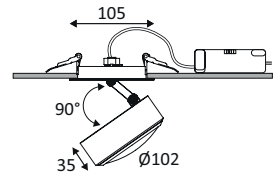

RETI 2 RX	COULEUR	MATIÈRE	P	CCT	LED LUMEN	SYSTEM LUMEN	α	€
DO561WW05	■ NOIR MAT	ALUMINIUM	18W	3000K	1620Lm	1490Lm	80°	245,00
DO561WW31	■ NOIR MAT - BRONZE SATINÉ	ALUMINIUM	18W	3000K	1620Lm	1490Lm	80°	245,00
DO561WW30	■ BLANC MAT	ALUMINIUM	18W	3000K	1620Lm	1490Lm	80°	245,00

DANS LA MÊME GAMME



NOIR MAT

NOIR MAT - BRONZE SATINÉ

BLANC MAT



RETI W PAGE 170



RETI P PAGE 236



RETI 1 RX



DOWNLIGHTS

DAX RD-230



- Downlight encastré rond fixe 4 en 1.
- 2700K, 3000K, 4000K ou 6000K au choix via un interrupteur à l'arrière du luminaire.
- Fixation par ressorts.
- Peut être recouvert par un isolant déroulé ou soufflé.
- Double bornier automatique.
- Ne nécessite pas de convertisseur.
- Dimmable.
- Compatible avec variateur fin de phase.

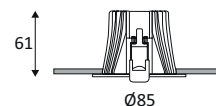

DAX RD-230	COULEUR	MATIÈRE	P	CCT	LED LUMEN	SYSTEM LUMEN	α	€
DO48730	BLANC MAT	COMPOSITE	6W	2700K 3000K 4000K 6000K	850Lm (4000K)	675Lm (4000K)	100°	29,00

SENSO R-230

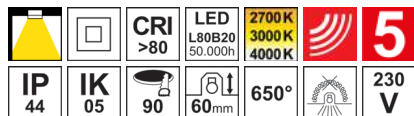

- Downlight encastré rond fixe 3 en 1.
- 2700K, 3000K ou 4000K au choix via un interrupteur à l'arrière du luminaire.
- Fixation par ressorts.
- Double bornier automatique.
- Avec détecteur IR 90°, zone de détection max. 5m de diamètre.
- Durée d'allumage de 3 minutes après détection.
- Fonctionne uniquement quand la luminosité est inférieure à 100 Lux.
- Ne nécessite pas de convertisseur.

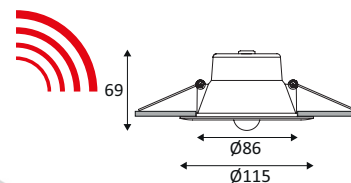

SENSO R-230	COULEUR	MATIÈRE	P	CCT	LED LUMEN	SYSTEM LUMEN	α	€
DO53605	NOIR MAT	COMPOSITE	9W	2700K 3000K 4000K	1800Lm (4000K)	950Lm (4000K)	100°	43,00
DO53630	BLANC MAT	COMPOSITE	9W	2700K 3000K 4000K	1800Lm (4000K)	950Lm (4000K)	100°	43,00



NOIR MAT



BLANC MAT



DAX RD-230



TIGA 1 RD EVO



- Downlight encastré rond fixe.
- 3000K, 4000K ou 6000K au choix via un interrupteur à l'arrière du luminaire.
- Fixation par ressorts.
- Convertisseur dimmable par coupure de phase déporté inclus.
- Peut être recouvert par un isolant déroulé, convertisseur compris.
- Double bornier automatique.
- Convertisseur ou source de remplacement disponibles séparément.

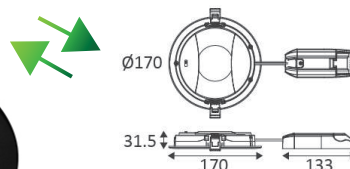

TIGA 1 RD EVO	COULEUR	MATIÈRE	P	CCT	LED LUMEN	SYSTEM LUMEN	α	€
DO56705 NEW	NOIR MAT	POLYCARBONATE	10W	3000K 4000K 6000K	1800Lm (4000K)	1300Lm (4000K)	100°	42,00
DO56730 NEW	BLANC MAT	POLYCARBONATE	10W	3000K 4000K 6000K	1800Lm (4000K)	1300Lm (4000K)	100°	42,00

CONVERTISSEURS ET SOURCES		LED	€
CDDO567	DRIVER TIGA 1 RD EVO 12W 105MA CC DIM	12W	10,00
LPDO567	SOURCE LED TIGA 1 RD EVO 9,5W 1800Lm	9,5W	10,00



NOIR MAT



BLANC MAT

TIGA 2 RD EVO



- Downlight encastré rond fixe.
- 3000K, 4000K ou 6000K au choix via un interrupteur à l'arrière du luminaire.
- Fixation par ressorts.
- Convertisseur dimmable par coupure de phase déporté inclus.
- Peut être recouvert par un isolant déroulé, convertisseur compris.
- Double bornier automatique.
- Convertisseur ou source de remplacement disponibles séparément.

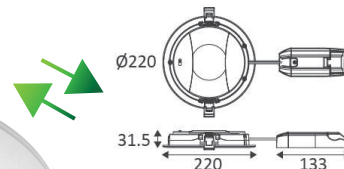

TIGA 2 RD EVO	COULEUR	MATIÈRE	P	CCT	LED LUMEN	SYSTEM LUMEN	α	€
DO56805 NEW	NOIR MAT	POLYCARBONATE	17W	3000K 4000K 6000K	2800Lm (4000K)	2200Lm (4000K)	110°	47,00
DO56830 NEW	BLANC MAT	POLYCARBONATE	17W	3000K 4000K 6000K	2800Lm (4000K)	2200Lm (4000K)	110°	47,00

CONVERTISSEURS ET SOURCES		LED	€
CDDO568 NEW	DRIVER TIGA 2 RD EVO 18W 110MA CC DIM	18W	10,00
LPDO568 NEW	SOURCE LED TIGA 2 RD EVO 15,5W 2800Lm	15,5W	10,00



NOIR MAT
110



BLANC MAT



TIGA 3 RD EVO



- Downlight encastré rond fixe.
- 3000K, 4000K ou 6000K au choix via un interrupteur à l'arrière du luminaire.
- Fixation par ressorts.
- Convertisseur dimmable par coupure de phase déporté inclus.
- Peut être recouvert par un isolant déroulé, convertisseur compris.
- Double bornier automatique.
- Convertisseur ou source de remplacement disponibles séparément.



TIGA 3 RD EVO	COULEUR	MATIÈRE	P	CCT	LED LUMEN	SYSTEM LUMEN	α	€
DO56905 NEW	NOIR MAT	POLYCARBONATE	21W	3000K 4000K 6000K	3525Lm	2800Lm	110°	53,00
DO56930 NEW	BLANC MAT	POLYCARBONATE	21W	3000K 4000K 6000K	3525Lm	2800Lm	110°	53,00
CONVERTISSEURS ET SOURCES		LED	€					
CDDO569 NEW	DRIVER TIGA 3 RD EVO 24W 160MA CC DIM		16,00					
LPDO569 NEW	SOURCE LED TIGA 3 RD EVO 19,5W 3525Lm	19,5W	20,00					



NOIR MAT



BLANC MAT



THEA LITE CSP 1

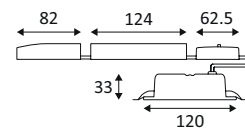
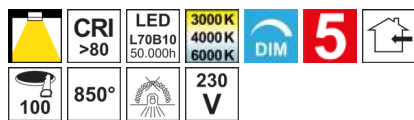

- Downlight encastré rond fixe 3 en 1.
- 3000K, 4000K ou 6000K au choix via un interrupteur à l'arrière du luminaire.
- Fixation par ressorts.
- Double bornier automatique.
- Connecteur Plug & Play inclus.
- THL1T : convertisseur dimmable coupure de phase déporté fourni.
- THL1X : convertisseur Dali, Push-Dim, 0-10V non fourni (PS250600MA à commander séparément).
- Kit d'éclairage de secours en option.

THEA LITE CSP 1	COULEUR	MATIÈRE	P	CCT	LED LUMEN	SYSTEM LUMEN	α	€
CONVERTISSEUR EXCLU								
THL1X	BLANC	ALUMINIUM	10W	3000K 4000K 6000K	1600Lm (4000K)	1200Lm (4000K)	80°	29,00
CONVERTISSEUR INCLUS								
THL1T	BLANC	ALUMINIUM	10W	3000K 4000K 6000K	1600Lm (4000K)	1200Lm (4000K)	80°	36,00

ACCESSOIRES	DESCRIPTION	L(MM)	€
LEDEP10	KIT ECLAIRAGE DE SECOURS	199	227,00

CONVERTISSEURS ET SOURCES POUR THEA LITE CSP 1, 2 ET 3		WATT MAX	€
PS250600MA	DRIVER 13-29W 250-600MA CC DALI PUSH-DIM 0-10V	13-29W	74,00





THEA LITE CSP 2

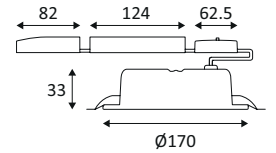
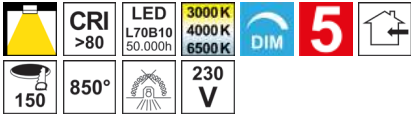

- Downlight encastré rond fixe 3 en 1.
- 3000K, 4000K ou 6500K au choix via un interrupteur à l'arrière du luminaire.
- Fixation par ressorts.
- Double bornier automatique.
- Connecteur Plug & Play inclus.
- THL2T : convertisseur dimmable coupure de phase déporté fourni.
- THL2X : convertisseur Dali, Push-Dim, 0-10V non fourni (PS250600MA à commander séparément).
- Kit d'éclairage de secours en option.

THEA LITE CSP 2	COULEUR	MATIÈRE	P	CCT	LED LUMEN	SYSTEM LUMEN	α	€
CONVERTISSEUR EXCLU								
THL2X	BLANC	ALUMINIUM	14W	3000K 4000K 6500K	2000Lm (4000K)	1680Lm (4000K)	90°	37,00
CONVERTISSEUR INCLUS								
THL2T	BLANC	ALUMINIUM	14W	3000K 4000K 6500K	2000Lm (4000K)	1680Lm (4000K)	90°	46,00
ACCESSOIRES	DESCRIPTION	L(MM)		€				
LEDEP10	KIT ECLAIRAGE DE SECOURS	199		227,00				

THEA LITE CSP 3

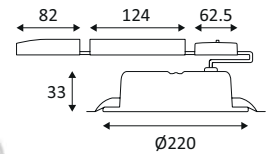
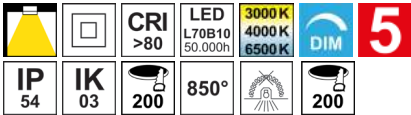

- Downlight encastré rond fixe 3 en 1.
- 3000K, 4000K ou 6500K au choix via un interrupteur à l'arrière du luminaire.
- Fixation par ressorts.
- Double bornier automatique.
- Connecteur Plug & Play inclus.
- THL3T : convertisseur dimmable coupure de phase déporté fourni.
- THL3X : convertisseur Dali, Push-Dim, 0-10V non fourni (PS250600MA à commander séparément).
- Kit d'éclairage de secours en option.
- Bague couvrant un diamètre de perçage de 240 à 290mm à commander séparément.

THEA LITE CSP 3	COULEUR	MATIÈRE	P	CCT	LED LUMEN	SYSTEM LUMEN	α	€
CONVERTISSEUR EXCLU								
THL3X	BLANC	ALUMINIUM	20W	3000K 4000K 6500K	2950Lm (4000K)	2400Lm (4000K)	90°	45,00
CONVERTISSEUR INCLUS								
THL3T	BLANC	ALUMINIUM	20W	3000K 4000K 6500K	2950Lm (4000K)	2400Lm (4000K)	90°	62,00
ACCESSOIRES	COULEUR	MATIÈRE	DESCRIPTION	L(MM)		€		
DL801MW	BLANC	ACIER	BAGUE DE MONTAGE 319MM			26,00		
LEDEP10			KIT ECLAIRAGE DE SECOURS	199		227,00		

FOX 2 RD

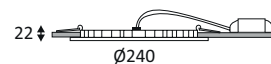
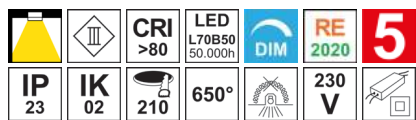

- Downlight encastré rond fixe.
- Fixation par ressorts.
- Convertisseur dimmable déporté fourni.
- Compatible avec variateur fin de phase.



FOX 2 RD	COULEUR	MATIÈRE	P	CCT	LED LUMEN	SYSTEM LUMEN	α	€
DO102WW05	■ NOIR MAT	FONTE D'ALUMINIUM	19W	3000K	2700Lm	1725Lm	110°	82,00
DO102WW30	■ BLANC MAT	FONTE D'ALUMINIUM	19W	3000K	2700Lm	1725Lm	110°	82,00
DO102NW05	■ NOIR MAT	FONTE D'ALUMINIUM	19W	4000K	2800Lm	1805Lm	110°	82,00
DO102NW30	■ BLANC MAT	FONTE D'ALUMINIUM	19W	4000K	2800Lm	1805Lm	110°	82,00





AL1016 RX

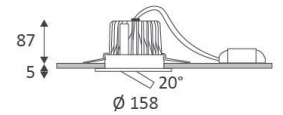

- Downlight encastré rond orientable.
- Fixation par ressorts.
- Convertisseur non dimmable déporté fourni.
- En option, convertisseur dimmable DALI, Push-Dim et 1-10V à commander séparément.

AL1016 RX	COULEUR	MATIÈRE	P	CCT	LED LUMEN	SYSTEM LUMEN	α	€
DO107WW30	BLANC MAT	FORTE D'ALUMINIUM	26W	3000K	2350Lm	2050Lm	30°	200,00
DO107NW30	BLANC MAT	FORTE D'ALUMINIUM	26W	4000K	2450Lm	2140Lm	30°	200,00
CONVERTISSEURS ET SOURCES			WATT MAX	€				
PSDAL700M	DRIVER 3-50W 700MA CC DIM 1-10V DALI PUSH		3-50W	146,00				



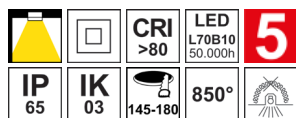

THEA PRO 1

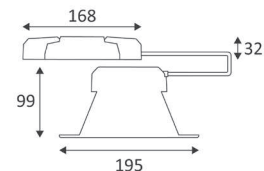

- Downlight encastré rond fixe.
- Diffuseur en polycarbonate opalin.
- Réflecteur basse luminance.
- Réflecteur pour UGR<19 en option.
- Fixation par ressorts.
- Peut être recouvert par un isolant, à l'exception du convertisseur.
- Double bornier automatique.
- Connecteur Plug & Play inclus.
- Convertisseur non dimmable déporté fourni ou convertisseur à commander séparément.
- Convertisseur dimmable DALI / Push-Dim en option.
- Kit d'éclairage de secours en option.



THEA PRO 1	COULEUR	MATIÈRE	P	CCT	LED LUMEN	SYSTEM LUMEN	α	€
CONVERTISSEUR EXCLU								
THP2X	BLANC	ALUMINIUM + THERMOPLASTIQUE	14W	4000K	2400Lm	2000Lm	80°	52,00
CONVERTISSEUR INCLUS								
THP2N	BLANC	ALUMINIUM + THERMOPLASTIQUE	10-14W	4000K	1600-2400Lm	1400-2000Lm	80°	57,00

ACCESSOIRES	DESCRIPTION	L(MM)		€
LEDEP10	KIT ECLAIRAGE DE SECOURS	199		227,00
THP12UGR	REFLECTEUR UGR<19 THP2			17,50

CONVERTISSEURS ET SOURCES		€
THP23DD	DRIVER DALI PUSH-DIM THP2	45,00





THEA PRO 2

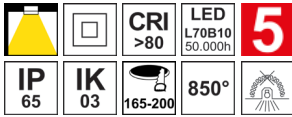

- Downlight encastré rond fixe.
- Diffuseur en polycarbonate opalin.
- Réflecteur basse luminance.
- Réflecteur pour UGR<19 en option.
- Fixation par ressorts.
- Peut être recouvert par un isolant, à l'exception du convertisseur.
- Double bornier automatique.
- Connecteur Plug & Play inclus.
- Convertisseur non dimmable déporté fourni ou convertisseur à commander séparément.
- Convertisseur dimmable DALI / Push-Dim en option.
- Kit d'éclairage de secours en option.
- Bague couvrant un diamètre de perçage de 240 à 290mm à commander séparément.

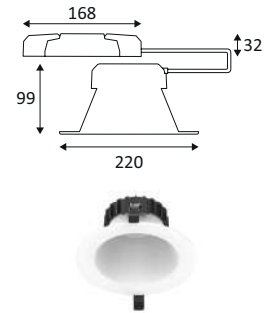

THEA PRO 2	COULEUR	MATIÈRE	P	CCT	LED LUMEN	SYSTEM LUMEN	α	€
CONVERTISSEUR EXCLU								
THP4X	BLANC	ALUMINIUM + THERMOPLASTIQUE	25W	4000K	4400Lm	3500Lm	80°	65,00
CONVERTISSEUR INCLUS								
THP4N	BLANC	ALUMINIUM + THERMOPLASTIQUE	25W	4000K	4400Lm	3500Lm	80°	70,00

ACCESSOIRES	COULEUR	MATIÈRE	DESCRIPTION	L(MM)	€
DL801MW	BLANC	ACIER	BAGUE DE MONTAGE 319MM		26,00
LEDEP10			KIT ECLAIRAGE DE SECOURS	199	227,00
THP34UGR			REFLECTEUR UGR<19 THP4		22,00

CONVERTISSEURS ET SOURCES		€
THP4DD	DRIVER DALI PUSH-DIM THP4	45,00

LYON 1 R

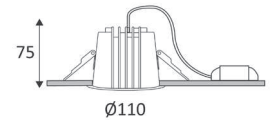
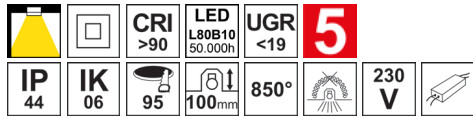

- Downlight encastré rond fixe.
- Réflecteur basse luminance.
- Fixation par ressorts.
- Convertisseur non-dimmable ou dimmable DALI-push déporté fourni.

LYON 1 R	COULEUR	MATIÈRE	P	CCT	LED LUMEN	SYSTEM LUMEN	α	€
NON DIMMABLE								
DO538WW05	■ NOIR MAT	ALUMINIUM	15W	3000K	1875Lm	1515Lm	60°	70,00
DO538WW17	▣ NOIR MAT - ARGENT	ALUMINIUM	15W	3000K	1875Lm	1590Lm	60°	72,00
DO538WW30	□ BLANC MAT	ALUMINIUM	15W	3000K	1875Lm	1590Lm	60°	70,00
DO538WW53	▤ BLANC MAT - ARGENT	ALUMINIUM	15W	3000K	1875Lm	1590Lm	60°	72,00
DO538NW05	■ NOIR MAT	ALUMINIUM	15W	4000K	1920Lm	1545Lm	60°	70,00
DO538NW17	▣ NOIR MAT - ARGENT	ALUMINIUM	15W	4000K	1920Lm	1625Lm	60°	72,00
DO538NW30	□ BLANC MAT	ALUMINIUM	15W	4000K	1920Lm	1625Lm	60°	70,00
DO538NW53	▤ BLANC MAT - ARGENT	ALUMINIUM	15W	4000K	1920Lm	1625Lm	60°	72,00
DIMMABLE DALI								
DO538WW05DA	■ NOIR MAT	ALUMINIUM	15W	3000K	1875Lm	1515Lm	60°	120,00
DO538WW17DA	▣ NOIR MAT - ARGENT	ALUMINIUM	15W	3000K	1875Lm	1590Lm	60°	122,00
DO538WW30DA	□ BLANC MAT	ALUMINIUM	15W	3000K	1875Lm	1590Lm	60°	120,00
DO538WW53DA	▤ BLANC MAT - ARGENT	ALUMINIUM	15W	3000K	1875Lm	1590Lm	60°	122,00
DO538NW05DA	■ NOIR MAT	ALUMINIUM	15W	4000K	1920Lm	1545Lm	60°	120,00
DO538NW17DA	▣ NOIR MAT - ARGENT	ALUMINIUM	15W	4000K	1920Lm	1625Lm	60°	122,00
DO538NW30DA	□ BLANC MAT	ALUMINIUM	15W	4000K	1920Lm	1625Lm	60°	120,00
DO538NW53DA	▤ BLANC MAT - ARGENT	ALUMINIUM	15W	4000K	1920Lm	1625Lm	60°	122,00





LYON 2 R

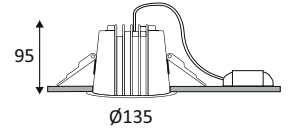

- Downlight encastré rond fixe.
- Réflecteur basse luminance.
- Fixation par ressorts.
- Convertisseur non-dimmable ou dimmable DALI-push déporté fourni.

LYON 2 R	COULEUR	MATIÈRE	P	CCT	LED LUMEN	SYSTEM LUMEN	α	€
NON DIMMABLE								
DO539WW05	■ NOIR MAT	ALUMINIUM	25W	3000K	3000Lm	2535Lm	60°	90,00
DO539WW17	▣ NOIR MAT - ARGENT	ALUMINIUM	25W	3000K	3000Lm	2670Lm	60°	95,00
DO539WW30	□ BLANC MAT	ALUMINIUM	25W	3000K	3000Lm	2670Lm	60°	90,00
DO539WW53	▤ BLANC MAT - ARGENT	ALUMINIUM	25W	3000K	3000Lm	2670Lm	60°	95,00
DO539NW05	■ NOIR MAT	ALUMINIUM	25W	4000K	3070Lm	2590Lm	60°	90,00
DO539NW17	▣ NOIR MAT - ARGENT	ALUMINIUM	25W	4000K	3070Lm	2750Lm	60°	95,00
DO539NW30	□ BLANC MAT	ALUMINIUM	25W	4000K	3070Lm	2750Lm	60°	90,00
DO539NW53	▤ BLANC MAT - ARGENT	ALUMINIUM	25W	4000K	3070Lm	2750Lm	60°	95,00
DIMMABLE DALI								
DO539WW05DA	■ NOIR MAT	ALUMINIUM	25W	3000K	3000Lm	2535Lm	60°	140,00
DO539WW17DA	▣ NOIR MAT - ARGENT	ALUMINIUM	25W	3000K	3000Lm	2670Lm	60°	145,00
DO539WW30DA	□ BLANC MAT	ALUMINIUM	25W	3000K	3000Lm	2670Lm	60°	140,00
DO539WW53DA	▤ BLANC MAT - ARGENT	ALUMINIUM	25W	3000K	3000Lm	2670Lm	60°	145,00
DO539NW05DA	■ NOIR MAT	ALUMINIUM	25W	4000K	3070Lm	2590Lm	60°	140,00
DO539NW17DA	▣ NOIR MAT - ARGENT	ALUMINIUM	25W	4000K	3070Lm	2750Lm	60°	145,00
DO539NW30DA	□ BLANC MAT	ALUMINIUM	25W	4000K	3070Lm	2750Lm	60°	140,00
DO539NW53DA	▤ BLANC MAT - ARGENT	ALUMINIUM	25W	4000K	3070Lm	2750Lm	60°	145,00



NOIR MAT

NOIR MAT - ARGENT

BLANC MAT

BLANC MAT - ARGENT



LYON 3 R

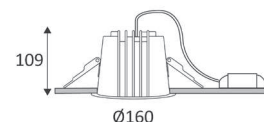
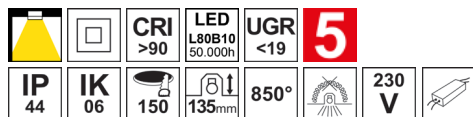

- Downlight encastré rond fixe.
- Réflecteur basse luminance.
- Fixation par ressorts.
- Convertisseur non-dimmable ou dimmable DALI-push déporté fourni.



LYON 3 R	COULEUR	MATIÈRE	P	CCT	LED LUMEN	SYSTEM LUMEN	α	€
NON DIMMABLE								
DO540WW05	■ NOIR MAT	ALUMINIUM	30W	3000K	4000Lm	3020Lm	60°	110,00
DO540WW17	▣ NOIR MAT - ARGENT	ALUMINIUM	30W	3000K	4000Lm	3180Lm	60°	115,00
DO540WW30	□ BLANC MAT	ALUMINIUM	30W	3000K	4000Lm	3180Lm	60°	110,00
DO540WW53	▤ BLANC MAT - ARGENT	ALUMINIUM	30W	3000K	4000Lm	3180Lm	60°	115,00
DO540NW05	■ NOIR MAT	ALUMINIUM	30W	4000K	4100Lm	3085Lm	60°	110,00
DO540NW17	▣ NOIR MAT - ARGENT	ALUMINIUM	30W	4000K	4100Lm	3275Lm	60°	115,00
DO540NW30	□ BLANC MAT	ALUMINIUM	30W	4000K	4100Lm	3275Lm	60°	110,00
DO540NW53	▤ BLANC MAT - ARGENT	ALUMINIUM	30W	4000K	4100Lm	3275Lm	60°	115,00
DIMMABLE DALI								
DO540WW05DA	■ NOIR MAT	ALUMINIUM	30W	3000K	4000Lm	3020Lm	60°	160,00
DO540WW17DA	▣ NOIR MAT - ARGENT	ALUMINIUM	30W	3000K	4000Lm	3180Lm	60°	165,00
DO540WW30DA	□ BLANC MAT	ALUMINIUM	30W	3000K	4000Lm	3180Lm	60°	160,00
DO540WW53DA	▤ BLANC MAT - ARGENT	ALUMINIUM	30W	3000K	4000Lm	3180Lm	60°	165,00
DO540NW05DA	■ NOIR MAT	ALUMINIUM	30W	4000K	4100Lm	3085Lm	60°	160,00
DO540NW17DA	▣ NOIR MAT - ARGENT	ALUMINIUM	30W	4000K	4100Lm	3275Lm	60°	165,00
DO540NW30DA	□ BLANC MAT	ALUMINIUM	30W	4000K	4100Lm	3275Lm	60°	160,00
DO540NW53DA	▤ BLANC MAT - ARGENT	ALUMINIUM	30W	4000K	4100Lm	3275Lm	60°	165,00



NOIR MAT NOIR MAT - ARGENT BLANC MAT BLANC MAT - ARGENT

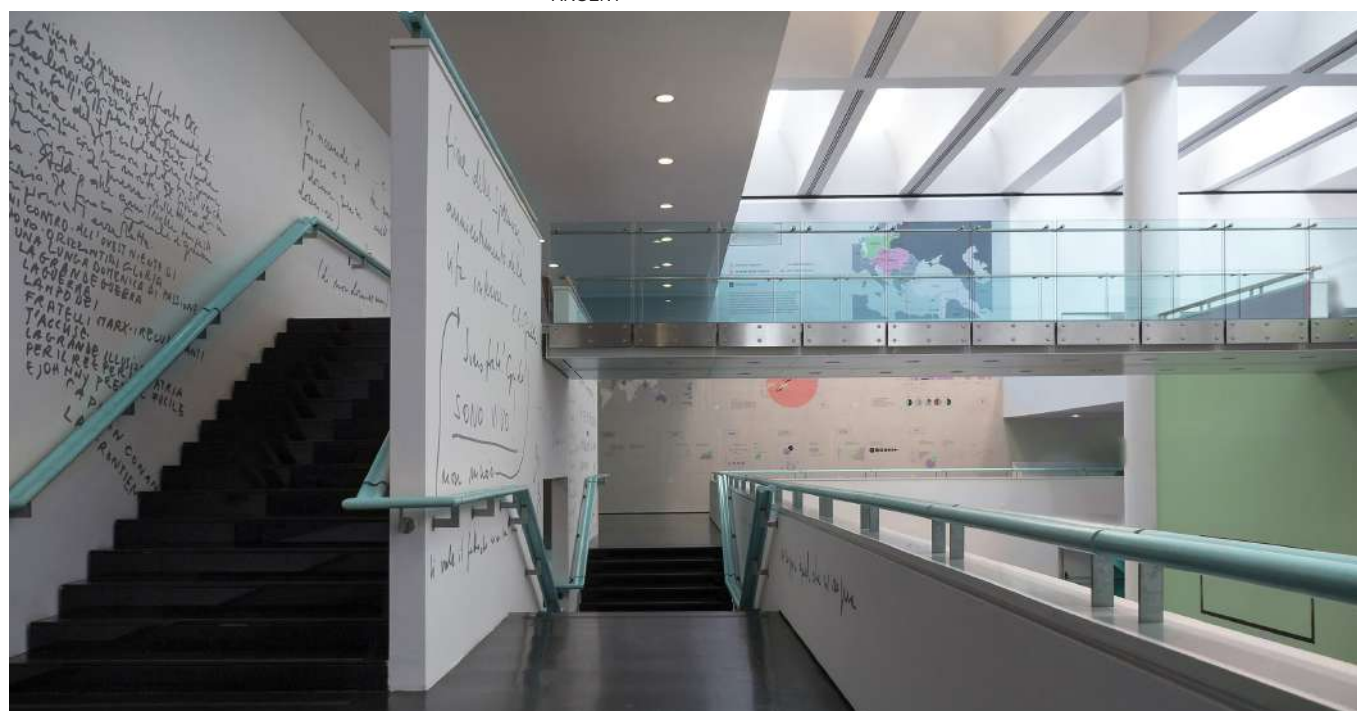



LYON 4 R

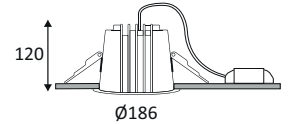
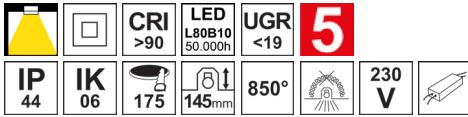

- Downlight encastré rond fixe.
- Réflecteur basse luminance.
- Fixation par ressorts.
- Convertisseur non-dimmable ou dimmable DALI-push déporté fourni.

LYON 4 R	COULEUR	MATIÈRE	P	CCT	LED LUMEN	SYSTEM LUMEN	α	€
NON DIMMABLE								
DO541WW05	■ NOIR MAT	ALUMINIUM	40W	3000K	5000Lm	3835Lm	60°	130,00
DO541WW17	▣ NOIR MAT - ARGENT	ALUMINIUM	40W	3000K	5000Lm	4035Lm	60°	135,00
DO541WW30	□ BLANC MAT	ALUMINIUM	40W	3000K	5000Lm	4035Lm	60°	130,00
DO541WW53	▤ BLANC MAT - ARGENT	ALUMINIUM	40W	3000K	5000Lm	4035Lm	60°	135,00
DO541NW05	■ NOIR MAT	ALUMINIUM	40W	4000K	5120Lm	3915Lm	60°	130,00
DO541NW17	▣ NOIR MAT - ARGENT	ALUMINIUM	40W	4000K	5120Lm	4160Lm	60°	135,00
DO541NW30	□ BLANC MAT	ALUMINIUM	40W	4000K	5120Lm	4160Lm	60°	130,00
DO541NW53	▤ BLANC MAT - ARGENT	ALUMINIUM	40W	4000K	5120Lm	4160Lm	60°	135,00
DIMMABLE DALI								
DO541WW05DA	■ NOIR MAT	ALUMINIUM	40W	3000K	5000Lm	3835Lm	60°	180,00
DO541WW17DA	▣ NOIR MAT - ARGENT	ALUMINIUM	40W	3000K	5000Lm	4035Lm	60°	185,00
DO541WW30DA	□ BLANC MAT	ALUMINIUM	40W	3000K	5000Lm	4035Lm	60°	180,00
DO541WW53DA	▤ BLANC MAT - ARGENT	ALUMINIUM	40W	3000K	5000Lm	4035Lm	60°	185,00
DO541NW05DA	■ NOIR MAT	ALUMINIUM	40W	4000K	5120Lm	3915Lm	60°	180,00
DO541NW17DA	▣ NOIR MAT - ARGENT	ALUMINIUM	40W	4000K	5120Lm	4160Lm	60°	185,00
DO541NW30DA	□ BLANC MAT	ALUMINIUM	40W	4000K	5120Lm	4160Lm	60°	180,00
DO541NW53DA	▤ BLANC MAT - ARGENT	ALUMINIUM	40W	4000K	5120Lm	4160Lm	60°	185,00



IZA 1 SDX

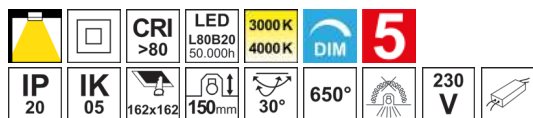

- Downlight encastré carré orientable 2 en 1.
- 3000K ou 4000K au choix via un interrupteur à l'arrière du luminaire.
- Fixation par ressorts.
- Convertisseur dimmable déporté fourni.
- Compatible avec variateur début et fin de phase.

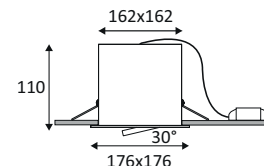

IZA 1 SDX	COULEUR	MATIÈRE	P	CCT	L(MM)	LED LUMEN	SYSTEM LUMEN	α	€
DO53105	■ NOIR MAT	ALUMINIUM	24W	3000K 4000K	176	3360Lm (4000K)	2645Lm (4000K)	60°	160,00
DO53130	□ BLANC MAT	ALUMINIUM	24W	3000K 4000K	176	3360Lm (4000K)	2645Lm (4000K)	60°	160,00



NOIR MAT

BLANC MAT

IZA 2 SDX

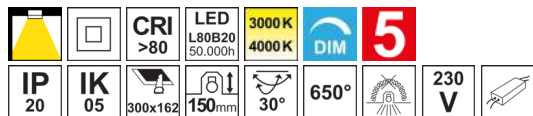

- Downlight encastré rectangulaire orientable 2 en 1.
- 3000K ou 4000K au choix via un interrupteur à l'arrière du luminaire.
- Fixation par ressorts.
- Convertisseurs dimmables déportés fournis.
- Compatible avec variateur début et fin de phase.

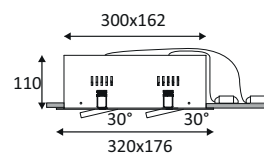

IZA 2 SDX	COULEUR	MATIÈRE	P	CCT	L(MM)	LED LUMEN	SYSTEM LUMEN	α	€
DO53205	■ NOIR MAT	ALUMINIUM	48W	3000K 4000K	320	2X3360Lm (4000K)	5315Lm (4000K)	60°	282,00
DO53230	□ BLANC MAT	ALUMINIUM	48W	3000K 4000K	320	2X3360Lm (4000K)	5315Lm (4000K)	60°	282,00



NOIR MAT

BLANC MAT



IZA 2 SDX





SPIRA 1 RX PLUS

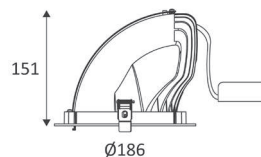

- Downlight encastré rond orientable 3 en 1.
- 2700K, 3000K ou 4000K au choix via un interrupteur sur le convertisseur.
- Verre de protection.
- Fixation par ressorts.
- Convertisseur non dimmable déporté fourni.
- Bague couvrant un diamètre de perçage de 220 à 240mm à commander séparément.



SPIRA 1 RX PLUS	COULEUR	MATIÈRE	P	CCT	LED LUMEN	SYSTEM LUMEN	α	€
DO48805	NOIR	FONTE D'ALUMINIUM	40W	2700K 3000K 4000K	4600Lm (4000K)	3325Lm (4000K)	40°	160,00
DO48804	BLANC	FONTE D'ALUMINIUM	40W	2700K 3000K 4000K	4600Lm (4000K)	3610Lm (4000K)	40°	160,00
ACCESSOIRES	COULEUR	MATIÈRE	DESCRIPTION					€
DO54804	BLANC	ALUMINIUM	BAGUE DE FINITION 250MM					21,00
DO54805	NOIR	ALUMINIUM	BAGUE DE FINITION 250MM					21,00



NOIR



BLANC





SPIRA 3 RX



- Downlight encastré rond orientable.
- Verre de protection.
- Fixation par ressorts.
- Convertisseur non dimmable déporté fourni.

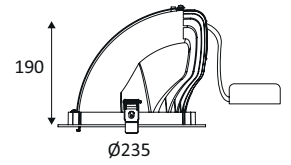

SPIRA 3 RX	COULEUR	MATIÈRE	P	CCT	LED LUMEN	SYSTEM LUMEN	α	€
DO344NW04	BLANC	FRONT D'ALUMINIUM	60W	4000K	8400Lm	6250Lm	40°	315,00



FOCEA 1 SX PLUS

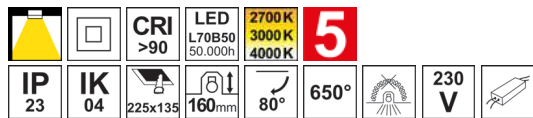

- Downlight encastré rectangulaire orientable 3 en 1.
- 2700K, 3000K ou 4000K au choix via un interrupteur sur le convertisseur.
- Verre de protection.
- Fixation par ressorts.
- Convertisseur non dimmable déporté fourni.

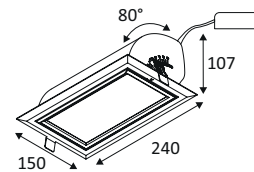

FOCEA 1 SX PLUS	COULEUR	MATIÈRE	P	CCT	L(MM)	LED LUMEN	SYSTEM LUMEN	α	€
DO48905	■ NOIR	FRONT D'ALUMINIUM	40W	2700K 3000K 4000K	240	3400Lm (4000K)	2305Lm (4000K)	60°	190,00
DO48904	■ BLANC	FRONT D'ALUMINIUM	40W	2700K 3000K 4000K	240	4600Lm (4000K)	3620Lm (4000K)	60°	190,00



NOIR



BLANC

FOCEA 2 SX

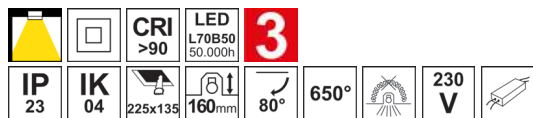

- Downlight encastré rectangulaire orientable.
- Verre de protection.
- Fixation par ressorts.
- Convertisseur non dimmable déporté fourni.

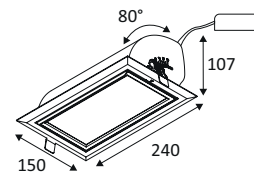

FOCEA 2 SX	COULEUR	MATIÈRE	P	CCT	L(MM)	LED LUMEN	SYSTEM LUMEN	α	€
DO346NW04	■ BLANC	FRONT D'ALUMINIUM	60W	4000K	240	8400Lm	6645Lm	60°	305,00



FOCEA 1 SX PLUS



DALLES LED

SOLIS 1

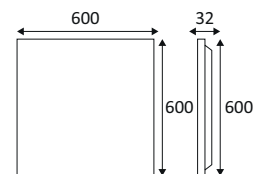

- Dalle LED 600x600mm.
- Diffuseur PS à structure prismatique.
- Connecteur rapide et filin de sécurité (1m) inclus.
- Peut être recouvert par un isolant, à l'exception du convertisseur.
- SOL66N : convertisseur non-dimmable déporté fourni.
- SOL66X : convertisseur Dali, Push-Dim, 0-10V non fourni (PS6501100MA à commander séparément).
- Kit de montage en saillie ou kit de suspension à commander séparément.
- Kit d'éclairage de secours en option.
- SOL66N : Multi-puissance : 27 ou 32W au choix via un interrupteur sur le convertisseur.



SOLIS 1	COULEUR	MATIÈRE	P	CCT	LED LUMEN	SYSTEM LUMEN	α	€
CONVERTISSEUR INCLUS								
SOL66N19D30IN NEW	BLANC	ACIER	27 - 32W	3000K	3800 (24W) 4400 (29W)	3360 (27W) 3910 (32W)	90°	54,00
SOL66N19D40IN NEW	BLANC	ACIER	27 - 32W	4000K	4000 (24W) 4650 (29W)	3610 (27W) 4190 (32W)	90°	54,00
CONVERTISSEUR EXCLUS								
SOL66X19D30 NEW	BLANC	ACIER	29W	3000K	4400Lm	3910Lm	90°	40,00
SOL66X19D40 NEW	BLANC	ACIER	29W	4000K	4650Lm	4190Lm	90°	40,00

ACCESSOIRES	COULEUR	MATIÈRE	DESCRIPTION	L(MM)	€
AU4/66 NEW	BLANC MAT	ALUMINIUM	CADRE DE MONTAGE EN SAILLIE POUR DALLES 600X600MM	600	50,00
AU4/66/LINK NEW	BLANC MAT	ALUMINIUM	MODULE DE LIAISON 600MM POUR CADRE DE MONTAGE EN SAILLIE	600	40,00
AZ7 NEW	BLANC MAT	INOX	KIT DE SUSPENSION L:1000MM		30,00
LEDEP10 NEW			KIT ECLAIRAGE DE SECOURS	199	227,00

CONVERTISSEURS ET SOURCES	WATT MAX	€
PS6501100MA NEW DRIVER 40W 650-1100mA CC DALI PUSH-DIM 0-10V	40W	55,00





SOLIS IP65

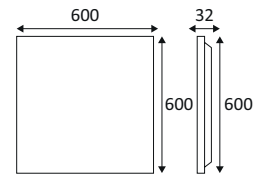

- Dalle LED 600x600mm.
- Diffuseur en polypropylène.
- Peut être recouvert par un isolant, à l'exception du convertisseur.
- Convertisseur non dimmable déporté fourni.
- Kit de montage en saillie ou kit de suspension à commander séparément.
- Kit d'éclairage de secours en option.

SOLIS IP65	COULEUR	MATIÈRE	P	CCT	L(MM)	LED LUMEN	SYSTEM LUMEN	α	€
SOLIP66N4K	BLANC	ALUMINIUM	40W	4000K	600	5400Lm	4500Lm	110°	80,00

ACCESSOIRES	COULEUR	MATIÈRE	DESCRIPTION	L(MM)	€
AU4/66	BLANC MAT	ALUMINIUM	CADRE DE MONTAGE EN SAILLIE POUR DALLES 600X600MM	600	50,00
AU4/66/LINK	BLANC MAT	ALUMINIUM	MODULE DE LIAISON 600MM POUR CADRE DE MONTAGE EN SAILLIE	600	40,00
AZ7	BLANC MAT	INOX	KIT DE SUSPENSION L:1000MM		30,00
LEDEP10			KIT ECLAIRAGE DE SECOURS	199	227,00



SOLIS 2

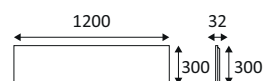
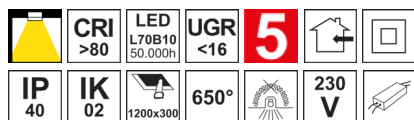

- Dalle LED 1200x300mm.
- Diffuseur PS à structure prismatique.
- Connecteur rapide et filin de sécurité (1m) inclus.
- Peut être recouvert par un isolant, à l'exception du convertisseur.
- Convertisseur non dimmable déporté fourni.
- Kit de montage en saillie ou kit de suspension à commander séparément.
- Kit d'éclairage de secours en option.



SOLIS 2	COULEUR	MATIÈRE	P	CCT	L(MM)	LED LUMEN	SYSTEM LUMEN	α	€
P2B16S30WA	BLANC	ALUMINIUM	30W	4000K	1200	4125Lm	3450Lm	90°	72,00

ACCESSOIRES	COULEUR	MATIÈRE	DESCRIPTION	L(MM)	€
AU4/312	BLANC MAT	ALUMINIUM	CADRE DE MONTAGE EN SAILLIE POUR DALLES 1200X300MM	1200	80,00
AU4/312/LINK	BLANC MAT	ALUMINIUM	MODULE DE LIAISON 300MM POUR CADRE DE MONTAGE EN SAILLIE	300	38,00
AZ7	BLANC MAT	INOX	KIT DE SUSPENSION L:1000MM		30,00
LEDEP10			KIT ECLAIRAGE DE SECOURS	199	227,00

CONVERTISSEURS ET SOURCES	WATT MAX	€
PS6501100MA DRIVER 40W 650-1100MA CC DALI PUSH-DIM 0-10V	40W	55,00



SOLIS 3

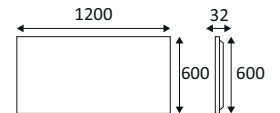
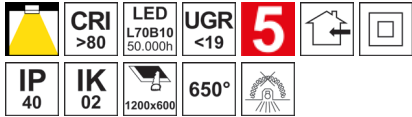

- Dalle LED 1200x600mm.
- Diffuseur PS à structure prismatique.
- Connecteur rapide et filin de sécurité (1m) inclus.
- Peut être recouvert par un isolant, à l'exception du convertisseur.
- P2C__N : convertisseur non-dimmable déporté fourni.
- P2C__X : convertisseur Dali, Push-Dim non fourni (TR28000677 à commander séparément).
- Kit de montage en saillie à commander séparément.
- Kit d'éclairage de secours en option.

SOLIS 3	COULEUR	MATIÈRE	P	CCT	L(MM)	LED LUMEN	SYSTEM LUMEN	α	€
CONVERTISSEUR EXCLU									
P2C19X60WA	BLANC	ALUMINIUM	60W	4000K	1200	8250Lm	6600Lm	90°	110,00
CONVERTISSEUR INCLUS									
P2C19S60WA	BLANC	ALUMINIUM	60W	4000K	1200	8250Lm	6600Lm	90°	137,00

ACCESSOIRES	COULEUR	MATIÈRE	DESCRIPTION	L(MM)	€
P2SMC	BLANC	ALUMINIUM	KIT DE MONTAGE EN SAILLIE	1200	73,00
LEDEP10			KIT ECLAIRAGE DE SECOURS	199	227,00

CONVERTISSEURS ET SOURCES	WATT MAX	€
TR28000677 DRIVER 60W 900-1750MA CC DALI PUSH-DIM	60W	77,00

SOLIS LENS





SOLIS LENS



- Dalle LED 600x600mm.
- Modules LED à basse luminance (UGR<16) facilement interchangeables.
- 3000K ou 4000K au choix via un interrupteur à l'arrière du luminaire.
- Double bornier automatique et filin de sécurité (1m) inclus.
- Convertisseur non-dimmable ou dimmable DALI déporté fourni.
- Kit de montage en saillie ou kit de suspension à commander séparément.
- Convertisseur ou module LED de remplacement disponibles séparément.



SOLIS LENS	COULEUR	MATIÈRE	P	CCT	LED LUMEN	SYSTEM LUMEN	α	€	
NON DIMMABLE									
LENBS66N	NEW	NOIR MAT - ARGENT	ACIER	25W	3000K 4000K	4400Lm (4000K)	3180Lm (4000K)	80°	90,00
LENWW66N	NEW	BLANC MAT	ACIER	25W	3000K 4000K	4400Lm (4000K)	3510Lm (4000K)	80°	90,00
DIMMABLE DALI									
LENBS66D	NEW	NOIR MAT - ARGENT	ACIER	25W	3000K 4000K	4400Lm (4000K)	3180Lm (4000K)	80°	140,00
LENWW66D	NEW	BLANC MAT	ACIER	25W	3000K 4000K	4400Lm (4000K)	3510Lm (4000K)	80°	140,00

ACCESSOIRES	COULEUR	MATIÈRE	DESCRIPTION	L(MM)	€	
AU4/66	NEW	BLANC MAT	ALUMINIUM	CADRE DE MONTAGE EN SAILLIE POUR DALLES 600X600MM	600	50,00
AU4/66/LINK	NEW	BLANC MAT	ALUMINIUM	MODULE DE LIAISON 600MM POUR CADRE DE MONTAGE EN SAILLIE	600	40,00
AZ7	NEW	BLANC MAT	INOX	KIT DE SUSPENSION L:1000MM		30,00

CONVERTISSEURS ET SOURCES	LED	€	
LENWREFL NEW	SOLIS LENS MODULE LED 24W 4400Lm 80°	24W	30,00
LENSREFL NEW	SOLIS LENS MODULE LED 24W 4400Lm 80°	24W	30,00
LENDRVN NEW	DRIVER 30W 700MA CC		11,00
LENDRVD NEW	DRIVER 26W 650MA CC DALI		65,00

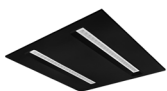

NOIR MAT - ARGENT



BLANC MAT

DOMINO



- Dalle LED 600x600mm.
- Lentilles en polycarbonate.
- Connecteur rapide et filin de sécurité inclus.
- Peut être recouvert par un isolant, à l'exception du convertisseur.
- Convertisseur dimmable DALI, Push-Dim et 0-10V à commander séparément.
- Kit de montage en saillie ou kit de suspension à commander séparément.
- Kit d'éclairage de secours en option.

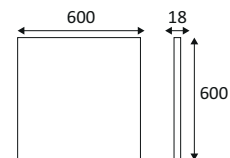

DOMINO	COULEUR	MATIÈRE	P	CCT	L(MM)	SYSTEM LUMEN	α	€
DMB66X4K	NOIR	ACIER	27W	4000K	600	4350Lm	75°	100,00
DMW66X4K	BLANC	ACIER	27W	4000K	600	4350Lm	75°	100,00

ACCESSOIRES	COULEUR	MATIÈRE	DESCRIPTION	L(MM)	€
AU4/66	BLANC MAT	ALUMINIUM	CADRE DE MONTAGE EN SAILLIE POUR DALLES 600X600MM	600	50,00
AU4/66/LINK	BLANC MAT	ALUMINIUM	MODULE DE LIAISON 600MM POUR CADRE DE MONTAGE EN SAILLIE	600	40,00
AZ7	BLANC MAT	INOX	KIT DE SUSPENSION L:1000MM		30,00
LEDEP10			KIT ECLAIRAGE DE SECOURS	199	227,00

CONVERTISSEURS ET SOURCES	WATT MAX	€
PS6501100MA DRIVER 40W 650-1100MA CC DALI PUSH-DIM 0-10V	40W	55,00



NOIR

BLANC



- Dalle LED pour faux-plafond modulaire.
- Excellent confort visuel grâce à un UGR inférieur à 16. Convient à l'éclairage de bureaux et salles de classe.
- Choix du mode de variation : convertisseur DALI, Push-dim et 0-10V à commander séparément.
- Rendement élevé (efficacité lumineuse supérieure à 160lm/W).
- Installation rapide et sûre grâce aux connecteur rapide et filin de sécurité inclus.
- Très bonne résistance aux chocs (IK08).
- Garantie de 5 ans.
- Kit d'éclairage de secours disponible en option.



DOMINO CSP

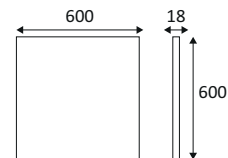

- Dalle LED 600x600mm.
- Lentilles en polycarbonate.
- Connecteur rapide et filin de sécurité inclus.
- Peut être recouvert par un isolant, à l'exception du convertisseur.
- Convertisseur non dimmable déporté fourni.
- Multi-puissance : 22, 24, 25 ou 27W au choix via un interrupteur sur le convertisseur.
- Kit de montage en saillie ou kit de suspension à commander séparément.
- Kit d'éclairage de secours en option.

DOMINO CSP	COULEUR	MATIÈRE	P	CCT	L(MM)	α	€
DMB66N4K	■ NOIR	ACIER	22 - 24 - 25 - 27W	4000K	600	75°	110,00
DMW66N4K	■ BLANC	ACIER	22 - 24 - 25 - 27W	4000K	600	75°	110,00

ACCESSOIRES	COULEUR	MATIÈRE	DESCRIPTION	L(MM)	€
AU4/66	BLANC MAT	ALUMINIUM	CADRE DE MONTAGE EN SAILLIE POUR DALLES 600X600MM	600	50,00
AU4/66/LINK	BLANC MAT	ALUMINIUM	MODULE DE LIAISON 600MM POUR CADRE DE MONTAGE EN SAILLIE	600	40,00
AZ7	BLANC MAT	INOX	KIT DE SUSPENSION L:1000MM		30,00
LEDEP10			KIT ECLAIRAGE DE SECOURS	199	227,00



NOIR



BLANC

ENCASTRÉS MURAUX

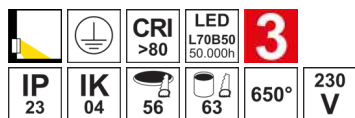
EVA 65R

- Encastré mural décoratif rond pour l'éclairage de circulations.
- Fixation par lamelles.
- Boîtier d'encastrement inclus.
- Ne nécessite pas de convertisseur.
- Non dimmable.

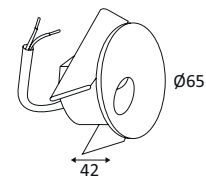

EVA 65R	COULEUR	MATIÈRE	P	CCT	LED LUMEN	SYSTEM LUMEN	€
DW110R31	BLANC	ALUMINIUM	4W	3000K	420Lm	180Lm	104,00

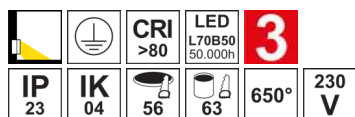
EVA 65S

- Encastré mural décoratif carré pour l'éclairage de circulations.
- Fixation par lamelles.
- Boîtier d'encastrement inclus.
- Ne nécessite pas de convertisseur.
- Non dimmable.

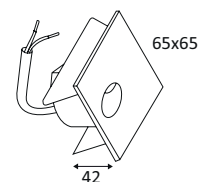

EVA 65S	COULEUR	MATIÈRE	P	CCT	L(MM)	LED LUMEN	SYSTEM LUMEN	€
DW110S31	BLANC	ALUMINIUM	4W	3000K	65	420Lm	205Lm	104,00

EVA 65R

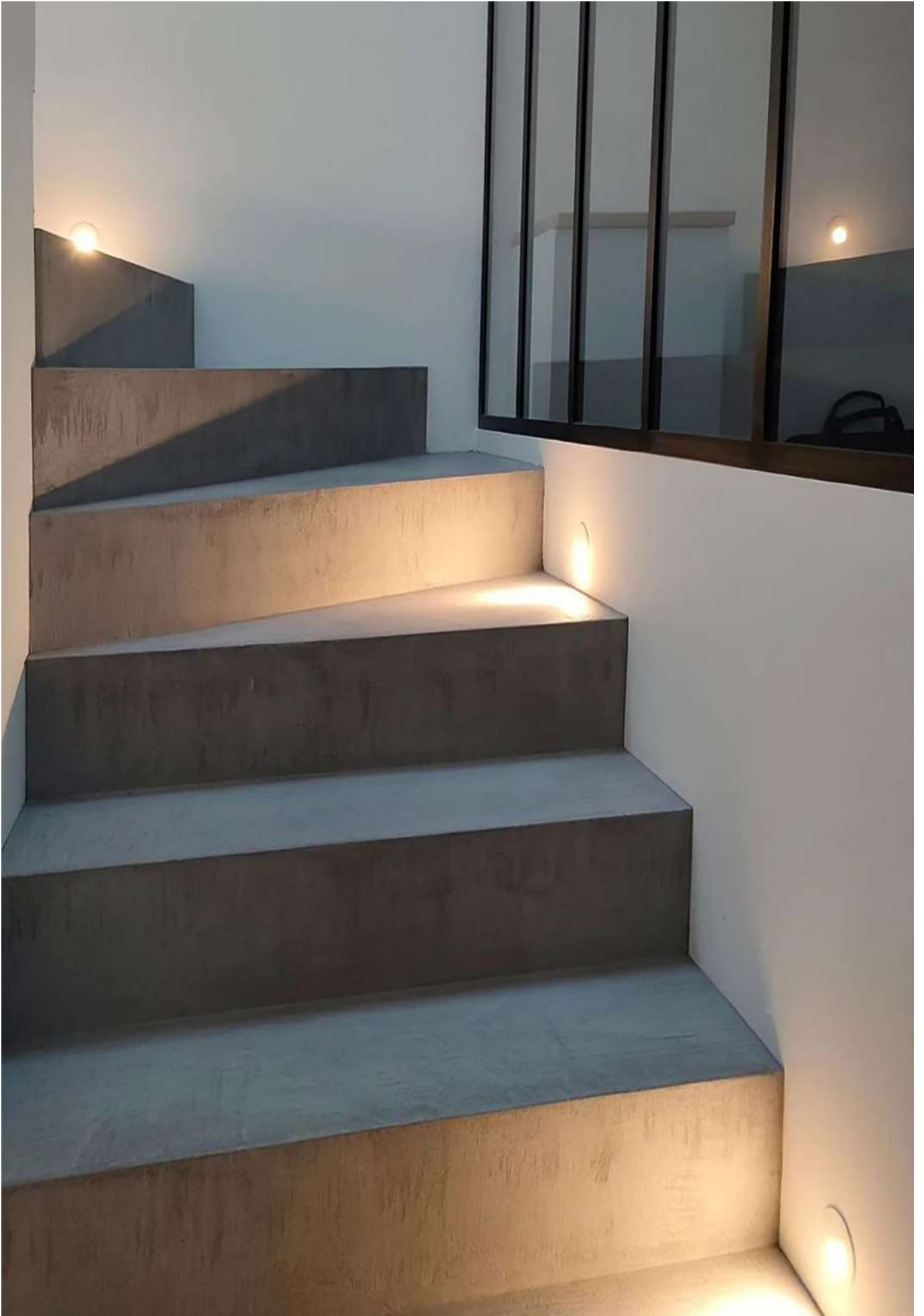

LIKA

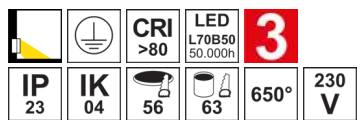

- Encastré mural décoratif carré pour l'éclairage de circulations.
- Fixation par lamelles.
- Boîtier d'encastrement inclus.
- Ne nécessite pas de convertisseur.
- Non dimmable.

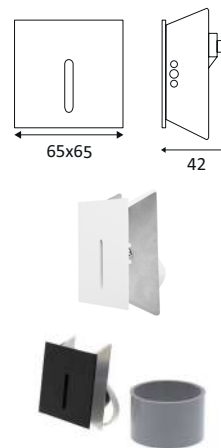

LIKA	COULEUR	MATIÈRE	P	CCT	L(MM)	LED LUMEN	SYSTEM LUMEN	€
WA173WW05	■ NOIR MAT	ALUMINIUM	4W	3000K	65	420Lm	80Lm	104,00
WA173WW30	■ BLANC MAT	ALUMINIUM	4W	3000K	65	420Lm	80Lm	104,00



NOIR MAT

BLANC MAT





MAKA

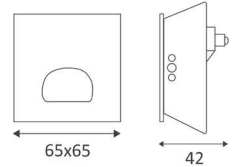
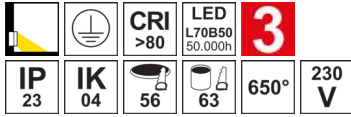

- Encastré mural décoratif carré pour l'éclairage de circulations.
- Fixation par lamelles.
- Boîtier d'encastrement inclus.
- Ne nécessite pas de convertisseur.
- Non dimmable.

MAKA	COULEUR	MATIÈRE	P	CCT	L(MM)	LED LUMEN	SYSTEM LUMEN	€
WA174WW05	NOIR MAT	ALUMINIUM	4W	3000K	65	420Lm	210Lm	104,00
WA174WW30	BLANC MAT	ALUMINIUM	4W	3000K	65	420Lm	210Lm	104,00



NOIR MAT



BLANC MAT

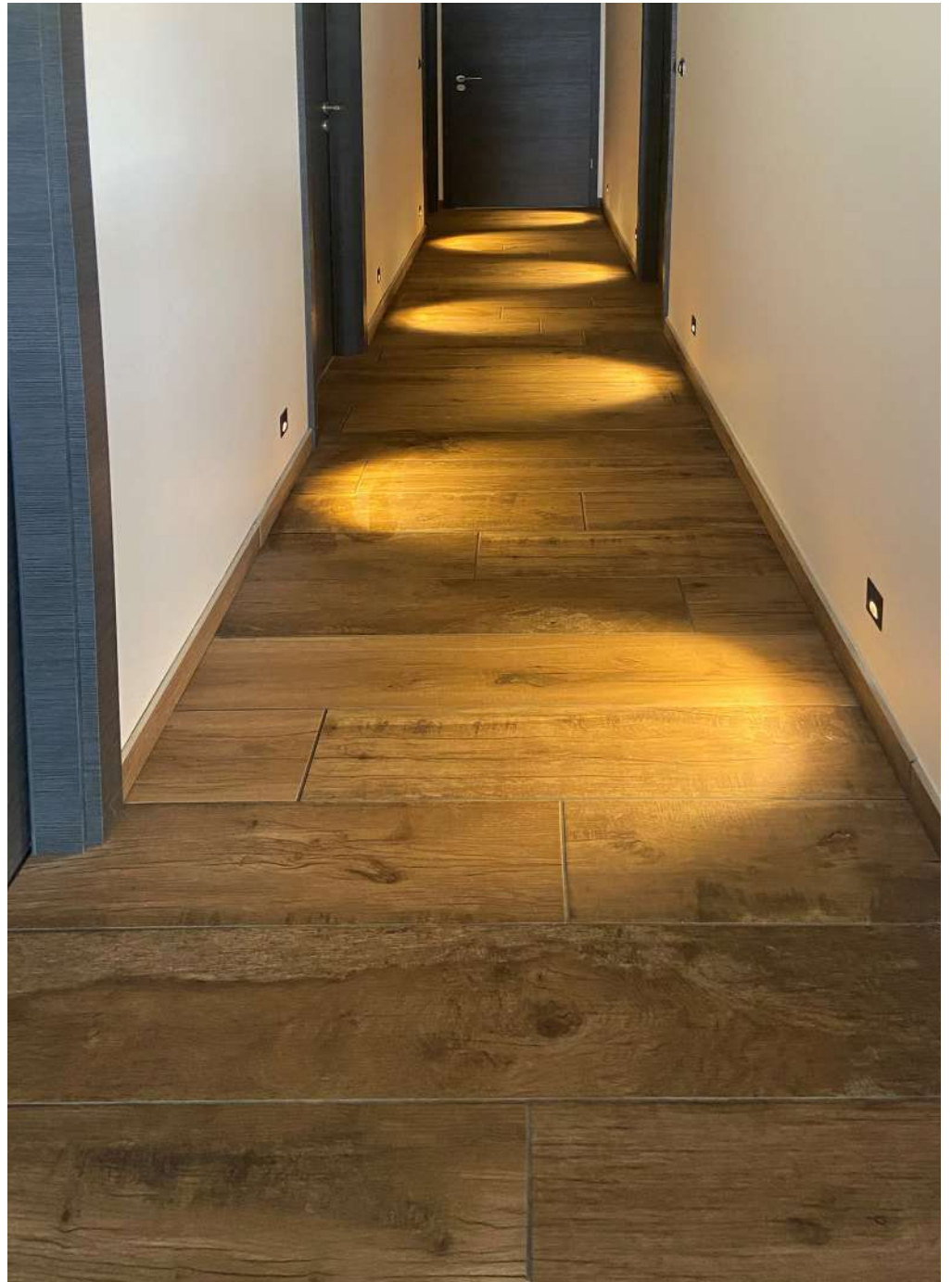

STEPBEAM

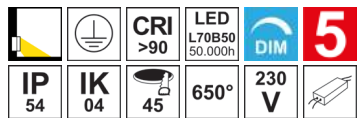

- Encastré mural décoratif pour l'éclairage de circulations.
- Face magnétique ronde ou carrée à commander séparément.
- Fixation par lamelles.
- Convertisseur dimmable déporté fourni.
- Compatible avec variateur début et fin de phase.

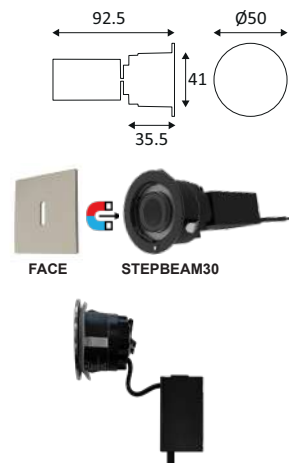

STEPBEAM	MATIÈRE	P	CCT	LED LUMEN	€
STEPBEAM30	ALUMINIUM	2,7W	3000K	255Lm	65,00





STEPBEAM

ACCESSOIRES	COULEUR	DESCRIPTION	L(MM)	€
FACES RONDES - DIFFUSION CIRCULAIRE				
RBEZCIRCLEB	NOIR	FACE RONDE DIFFUSION CIRCULAIRE		6,00
RBEZCIRCLES	CHROME SATINÉ	FACE RONDE DIFFUSION CIRCULAIRE		8,00
RBEZCIRCLEW	BLANC	FACE RONDE DIFFUSION CIRCULAIRE		6,00
FACES RONDES - DIFFUSION DEMI-CIRCULAIRE				
RBEZHIRCLEB	NOIR	FACE RONDE DIFFUSION DEMI-CIRCULAIRE		6,00
RBEZHIRCLES	CHROME SATINÉ	FACE RONDE DIFFUSION DEMI-CIRCULAIRE		8,00
RBEZHIRCLEW	BLANC	FACE RONDE DIFFUSION DEMI-CIRCULAIRE		6,00
FACES RONDES - DIFFUSION LINÉAIRE				
RBEZSLOTB	NOIR	FACE RONDE DIFFUSION LINÉAIRE		6,00
RBEZSLOTW	BLANC	FACE RONDE DIFFUSION LINÉAIRE		6,00
RBEZSLOTWS	CHROME SATINÉ	FACE RONDE DIFFUSION LINÉAIRE		8,00
FACES CARRÉES - DIFFUSION CIRCULAIRE				
SBEZCIRCLEB	NOIR	FACE CARRÉE DIFFUSION CIRCULAIRE	55	6,00
SBEZCIRCLES	CHROME SATINÉ	FACE CARRÉE DIFFUSION CIRCULAIRE	55	8,00
SBEZCIRCLEW	BLANC	FACE CARRÉE DIFFUSION CIRCULAIRE	55	6,00
FACES CARRÉES - DIFFUSION DEMI-CIRCULAIRE				
SBEZHIRCLEB	NOIR	FACE CARRÉE DIFFUSION DEMI-CIRCULAIRE	55	6,00
SBEZHIRCLES	CHROME SATINÉ	FACE CARRÉE DIFFUSION DEMI-CIRCULAIRE	55	8,00
SBEZHIRCLEW	BLANC	FACE CARRÉE DIFFUSION DEMI-CIRCULAIRE	55	6,00
FACES CARRÉES - DIFFUSION LINÉAIRE				
SBEZSLOTB	NOIR	FACE CARRÉE DIFFUSION LINÉAIRE	55	6,00
SBEZSLOTW	BLANC	FACE CARRÉE DIFFUSION LINÉAIRE	55	6,00
SBEZSLOTWS	CHROME SATINÉ	FACE CARRÉE DIFFUSION LINÉAIRE	55	8,00

APPLIQUES

EVIA G9



- Applique murale décorative.
- Diffuseur en verre opalin.
- Lampe LED G9 8W 3000K incluse.

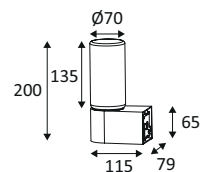

EVIA G9	COULEUR	MATIÈRE	DOUILLE	WATT MAX	CCT	LED LUMEN	SYSTEM LUMEN	€
WA25404	BLANC	ACIER	G9	8W	3000K	900Lm	570Lm	135,00
WA25403	CHROME	ACIER	G9	8W	3000K	900Lm	570Lm	141,00
WA25445	NICKEL MAT	ACIER	G9	8W	3000K	900Lm	570Lm	141,00
WA25461	LAITON BROSSÉ	INOX	G9	8W	3000K	900Lm	570Lm	175,00



BLANC



CHROME



NICKEL MAT



LAITON BROSSÉ

VITEL GX53



- Applique murale ou plafonnier décoratif.
- Diffuseur en verre pyramidal clair.
- Lampe LED GX53 9W 3000K incluse.

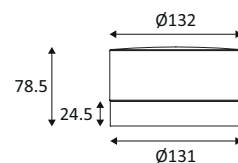

VITEL GX53	COULEUR	MATIÈRE	DOUILLE	WATT MAX	CCT	LED LUMEN	SYSTEM LUMEN	€
WA25330	BLANC MAT	POLYCARBONATE	GX53	9W	3000K	800Lm	525Lm	157,00
WA25303	CHROME	POLYCARBONATE	GX53	9W	3000K	800Lm	525Lm	160,00
WA25345	NICKEL MAT	POLYCARBONATE	GX53	9W	3000K	800Lm	525Lm	160,00
WA25361	LAITON BROSSÉ	POLYCARBONATE	GX53	9W	3000K	800Lm	525Lm	160,00



BLANC MAT



CHROME



NICKEL MAT



LAITON BROSSÉ



SNOOP GU10

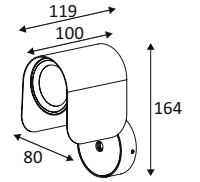

- Applique murale décorative pour éclairage intérieur et extérieur.
- Cache de finition magnétique adaptable en hauteur afin de modifier la luminance.
- Avec entrée et sortie de câble.

SNOOP GU10	COULEUR	MATIÈRE	DOUILLE	LAMPE	WATT MAX	€
WA26105	NOIR MAT	ALUMINIUM	GU10	PAR16 LED	10W	83,00
WA26135	NOIR MAT - BLANC MAT	ALUMINIUM	GU10	PAR16 LED	10W	83,00
WA26108	NOIR MAT - CHAMPAGNE	ALUMINIUM	GU10	PAR16 LED	10W	99,00
WA26183	NOIR MAT - ROSE	ALUMINIUM	GU10	PAR16 LED	10W	99,00



NOIR MAT



NOIR MAT - BLANC MAT



NOIR MAT - CHAMPAGNE



NOIR MAT - ROSE

SNOOP

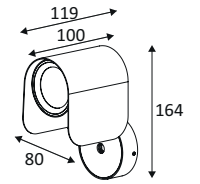
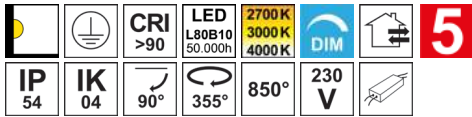

- Applique murale décorative pour éclairage intérieur et extérieur.
- Cache de finition magnétique adaptable en hauteur afin de modifier la luminance.
- 2700K, 3000K ou 4000K au choix via un interrupteur à l'arrière du luminaire.
- Avec entrée et sortie de câble.
- Convertisseur dimmable intégré dans l'appareil.
- Compatible avec variateur fin de phase.

SNOOP	COULEUR	MATIÈRE	P	CCT	LED LUMEN	SYSTEM LUMEN	α	€
WA26205	NOIR MAT	ALUMINIUM	10W	2700K 3000K 4000K	1050Lm (4000K)	865Lm (4000K)	38°	135,00
WA26235	NOIR MAT - BLANC MAT	ALUMINIUM	10W	2700K 3000K 4000K	1050Lm (4000K)	865Lm (4000K)	38°	135,00
WA26208	NOIR MAT - CHAMPAGNE	ALUMINIUM	10W	2700K 3000K 4000K	1050Lm (4000K)	865Lm (4000K)	38°	155,00
WA26283	NOIR MAT - ROSE	ALUMINIUM	10W	2700K 3000K 4000K	1050Lm (4000K)	865Lm (4000K)	38°	155,00



NOIR MAT



NOIR MAT - BLANC MAT



NOIR MAT - CHAMPAGNE



NOIR MAT - ROSE

JUPI

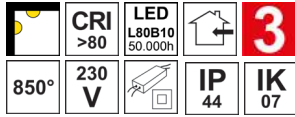

- Réglette de salle de bain, cuisine ou local technique.
- Montage en applique.
- Diffuseur en polycarbonate.
- Convertisseur non dimmable intégré dans l'appareil.
- 3 versions disponibles : standard (WA270), avec interrupteur (WA271) ou avec interrupteur et prise 2P+T 16A (WA273).

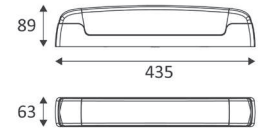





JUPI	COULEUR	MODÈLE	P	CCT	LED LUMEN	SYSTEM LUMEN	α	€
WA270WW04  NEW	BLANC	STANDARD	10W	3000K	1070Lm	830Lm	160°	38,00
WA271WW04  NEW	BLANC	INTER.	10W	3000K	1070Lm	830Lm	160°	40,00
WA273WW04  NEW	BLANC	INTER. + PRISE	10W	3000K	1070Lm	830Lm	160°	45,00

JUPI S19

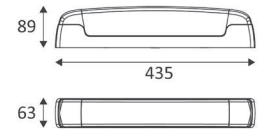

- Réglette de salle de bain, cuisine ou local technique.
- Montage en applique.
- Diffuseur en polycarbonate.
- Source lumineuse S19 non-incluse.
- 3 versions disponibles : standard (WA265), avec interrupteur (WA266) ou avec interrupteur et prise 2P+T 16A (WA268).



JUPI S19	COULEUR	MODÈLE	DOUILLE	WATT MAX	€
WA26504  NEW	BLANC	STANDARD	S19	30W	20,00
WA26604  NEW	BLANC	INTER.	S19	30W	22,00
WA26804  NEW	BLANC	INTER. + PRISE	S19	30W	25,00

JUPI



RONDY 1 W

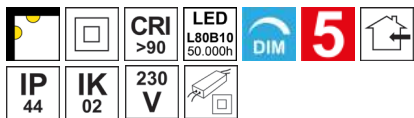

- Applique murale ou plafonnier décoratif.
- Diffuseur en verre opalin.
- Convertisseur dimmable par coupure de phase intégré dans l'appareil.

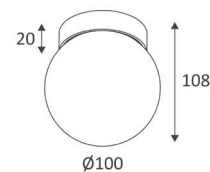

RONDY 1 W	COULEUR	MATIÈRE	P	CCT	LED LUMEN	SYSTEM LUMEN	€
WA279WW05 NEW	NOIR MAT	ALUMINIUM	6,6W	3000K	865Lm	755Lm	120,00
WA279WW30 NEW	BLANC MAT	ALUMINIUM	6,6W	3000K	865Lm	755Lm	120,00
WA279WW58 NEW	GRIS CANON DE FUSIL	ALUMINIUM	6,6W	3000K	865Lm	755Lm	150,00
WA279WW61 NEW	LAITON BROSSÉ	ALUMINIUM	6,6W	3000K	865Lm	755Lm	150,00



NOIR MAT



BLANC MAT



GRIS CANON DE FUSIL



LAITON BROSSÉ

RONDY 2 W



- Applique murale décorative.
- Diffuseur en verre opalin.
- Convertisseur dimmable par coupure de phase intégré dans l'appareil.

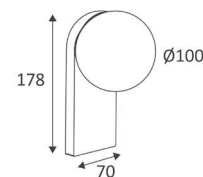

RONDY 2 W	COULEUR	MATIÈRE	P	CCT	LED LUMEN	SYSTEM LUMEN	€
WA280WW05 NEW	NOIR MAT	ALUMINIUM	6,6W	3000K	865Lm	770Lm	190,00
WA280WW30 NEW	BLANC MAT	ALUMINIUM	6,6W	3000K	865Lm	770Lm	190,00
WA280WW58 NEW	GRIS CANON DE FUSIL	ALUMINIUM	6,6W	3000K	865Lm	770Lm	220,00
WA280WW61 NEW	LAITON BROSSÉ	ALUMINIUM	6,6W	3000K	865Lm	770Lm	220,00



NOIR MAT



BLANC MAT



GRIS CANON DE FUSIL



LAITON BROSSÉ

RONDY 2 W



DIPLO 1

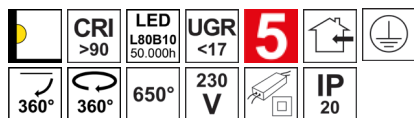

- Applique murale décorative.
- Base apparente avec interrupteur.
- Peut être montée sur une boîte d'encastrement de 68mm.
- Longueur du flexible: 300mm.
- Convertisseur non-dimmable intégré dans l'appareil.

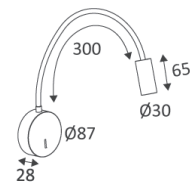

DIPLO 1	COULEUR	MATIÈRE	P	CCT	LED LUMEN	SYSTEM LUMEN	α	€
WA275WW05 NEW	■ NOIR MAT	ALUMINIUM	4,6W	3000K	360Lm	300Lm	34°	125,00
WA275WW30 NEW	■ BLANC MAT	ALUMINIUM	4,6W	3000K	360Lm	325Lm	34°	125,00
WA275WW58 NEW	■ GRIS CANON DE FUSIL	ALUMINIUM	4,6W	3000K	360Lm	300Lm	34°	150,00
WA275WW61 NEW	■ LAITON BROSSÉ	ALUMINIUM	4,6W	3000K	360Lm	300Lm	34°	150,00



NOIR MAT



BLANC MAT



GRIS CANON DE FUSIL



LAITON BROSSÉ

DIPLO 2



- Applique murale décorative.
- Base semi-encastrée avec interrupteur et prise USB-C (5VDC, 2A).
- Boîtier d'encastrement inclus.
- Longueur du flexible: 300mm.
- Convertisseur non-dimmable intégré dans l'appareil.

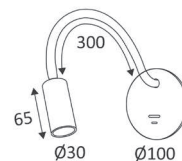

DIPLO 2	COULEUR	MATIÈRE	P	CCT	LED LUMEN	SYSTEM LUMEN	α	€
WA276WW05 NEW	■ NOIR MAT	ALUMINIUM	4,6W	3000K	360Lm	300Lm	34°	150,00
WA276WW30 NEW	■ BLANC MAT	ALUMINIUM	4,6W	3000K	360Lm	325Lm	34°	150,00
WA276WW58 NEW	■ GRIS CANON DE FUSIL	ALUMINIUM	4,6W	3000K	360Lm	300Lm	34°	175,00
WA276WW61 NEW	■ LAITON BROSSÉ	ALUMINIUM	4,6W	3000K	360Lm	300Lm	34°	175,00



NOIR MAT



BLANC MAT



GRIS CANON DE FUSIL



LAITON BROSSÉ

DIPLO 1



LIVRO GU10

- Applique murale décorative.
- Base apparente avec interrupteur.

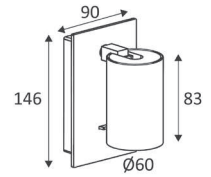

LIVRO GU10	COULEUR	MATIÈRE	L(MM)	DOUILLE	LAMPE	WATT MAX	€
WA27405 NEW	■ NOIR MAT	ALUMINIUM	105	GU10	PAR16 LED	8W	95,00
WA27455 NEW	■ NOIR MAT - LAITON	ALUMINIUM	105	GU10	PAR16 LED	8W	120,00
WA27430 NEW	■ BLANC MAT	ALUMINIUM	105	GU10	PAR16 LED	8W	95,00
WA27454 NEW	■ BLANC MAT - LAITON BROSSÉ	ALUMINIUM	105	GU10	PAR16 LED	8W	120,00



NOIR MAT



NOIR MAT - LAITON



BLANC MAT



BLANC MAT - LAITON BROSSÉ

LIVRO GU10



NEW

LUSY R

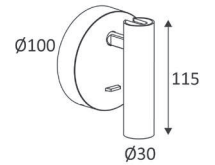

- Applique murale décorative.
- Base apparente avec interrupteur, 1 prise USB-A et 1 prise USB-C (5VDC, 2A).
- Peut être montée sur une boîte d'encastrement de 68mm.
- Convertisseur non-dimmable intégré dans l'appareil.

LUSY R	COULEUR	MATIÈRE	P	CCT	L(MM)	LED LUMEN	SYSTEM LUMEN	α	€
WA277WW05	NOIR MAT	ALUMINIUM	6,3W	3000K	115	475Lm	410Lm	34°	160,00
WA277WW30	BLANC MAT	ALUMINIUM	6,3W	3000K	115	475Lm	410Lm	34°	160,00
WA277WW58	GRIS CANON DE FUSIL	ALUMINIUM	6,3W	3000K	115	475Lm	410Lm	34°	185,00
WA277WW61	LAITON BROSSÉ	ALUMINIUM	6,3W	3000K	115	475Lm	410Lm	34°	185,00



NOIR MAT



BLANC MAT



GRIS CANON DE FUSIL



LAITON BROSSÉ

LUSY S

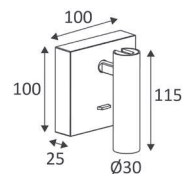

- Applique murale décorative.
- Base apparente avec interrupteur, 1 prise USB-A et 1 prise USB-C (5VDC, 2A).
- Peut être montée sur une boîte d'encastrement de 68mm.
- Convertisseur non-dimmable intégré dans l'appareil.

LUSY S	COULEUR	MATIÈRE	P	CCT	L(MM)	LED LUMEN	SYSTEM LUMEN	α	€
WA278WW05	NOIR MAT	ALUMINIUM	6,3W	3000K	115	475Lm	410Lm	34°	165,00
WA278WW30	BLANC MAT	ALUMINIUM	6,3W	3000K	115	475Lm	410Lm	34°	165,00
WA278WW58	GRIS CANON DE FUSIL	ALUMINIUM	6,3W	3000K	115	475Lm	410Lm	34°	190,00
WA278WW61	LAITON BROSSÉ	ALUMINIUM	6,3W	3000K	115	475Lm	410Lm	34°	190,00



NOIR MAT



BLANC MAT



GRIS CANON DE FUSIL



LAITON BROSSÉ

AUREA 3 W

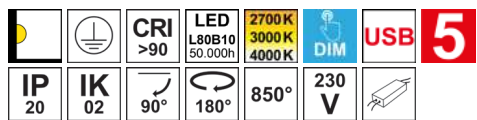

- Applique murale décorative.
- Base apparente avec interrupteur variateur et prise USB (5VDC, 2,4A).
- 2700K, 3000K ou 4000K au choix via un interrupteur à l'arrière du luminaire.
- Convertisseur dimmable intégré dans l'appareil.

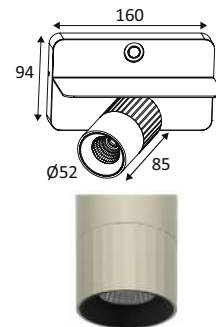

AUREA 3 W	COULEUR	MATIÈRE	P	CCT	LED LUMEN	SYSTEM LUMEN	α	€
WA26005	■ NOIR MAT	ALUMINIUM	7W	2700K 3000K 4000K	625Lm (4000K)	500Lm (4000K)	38°	140,00
WA26008	■ NOIR MAT - CHAMPAGNE	ALUMINIUM	7W	2700K 3000K 4000K	625Lm (4000K)	500Lm (4000K)	38°	160,00
WA26083	■ NOIR MAT - ROSE	ALUMINIUM	7W	2700K 3000K 4000K	625Lm (4000K)	500Lm (4000K)	38°	160,00
WA26030	■ BLANC MAT	ALUMINIUM	7W	2700K 3000K 4000K	625Lm (4000K)	500Lm (4000K)	38°	140,00
WA26049	■ BLANC MAT - CHAMPAGNE	ALUMINIUM	7W	2700K 3000K 4000K	625Lm (4000K)	500Lm (4000K)	38°	160,00
WA26082	■ BLANC MAT - ROSE	ALUMINIUM	7W	2700K 3000K 4000K	625Lm (4000K)	500Lm (4000K)	38°	160,00



DANS LA MÊME GAMME

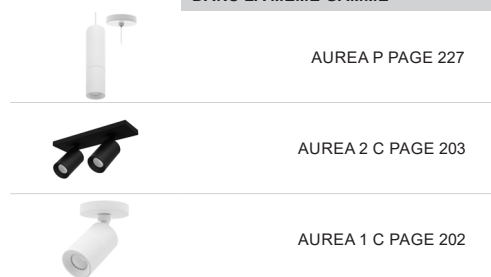



AUREA 4 W

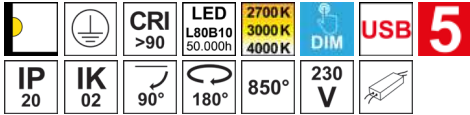

- Applique murale décorative.
- Base apparente avec interrupteur variateur, prise USB (5VDC, 2,4A) et chargeur sans-fil (pour smartphones compatibles).
- La charge par induction nécessite que le smartphone soit mis en contact direct avec la surface de recharge, sans protection ou coque.
- 2700K, 3000K ou 4000K au choix via un interrupteur à l'arrière du luminaire.
- Convertisseur dimmable intégré dans l'appareil.

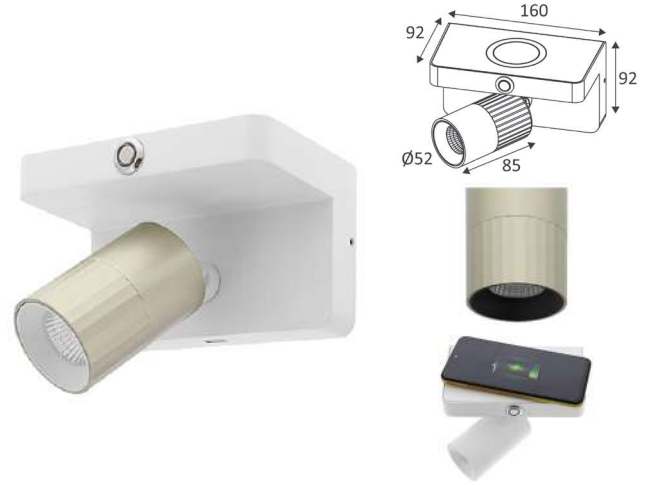

AUREA 4 W	COULEUR	MATIÈRE	P	CCT	LED LUMEN	SYSTEM LUMEN	α	€
WA26305	■ NOIR MAT	ALUMINIUM	7W	2700K 3000K 4000K	625Lm (4000K)	500Lm (4000K)	38°	145,00
WA26308	▣ NOIR MAT - CHAMPAGNE	ALUMINIUM	7W	2700K 3000K 4000K	625Lm (4000K)	500Lm (4000K)	38°	165,00
WA26383	▣ NOIR MAT - ROSE	ALUMINIUM	7W	2700K 3000K 4000K	625Lm (4000K)	500Lm (4000K)	38°	165,00
WA26330	■ BLANC MAT	ALUMINIUM	7W	2700K 3000K 4000K	625Lm (4000K)	500Lm (4000K)	38°	145,00
WA26349	▣ BLANC MAT - CHAMPAGNE	ALUMINIUM	7W	2700K 3000K 4000K	625Lm (4000K)	500Lm (4000K)	38°	165,00
WA26382	▣ BLANC MAT - ROSE	ALUMINIUM	7W	2700K 3000K 4000K	625Lm (4000K)	500Lm (4000K)	38°	165,00

DANS LA MÊME GAMME



NOIR MAT



NOIR MAT - CHAMPAGNE



NOIR MAT - ROSE



BLANC MAT



BLANC MAT - CHAMPAGNE



BLANC MAT - ROSE



AUREA P PAGE 227



AUREA 2 C PAGE 203



AUREA 1 C PAGE 202

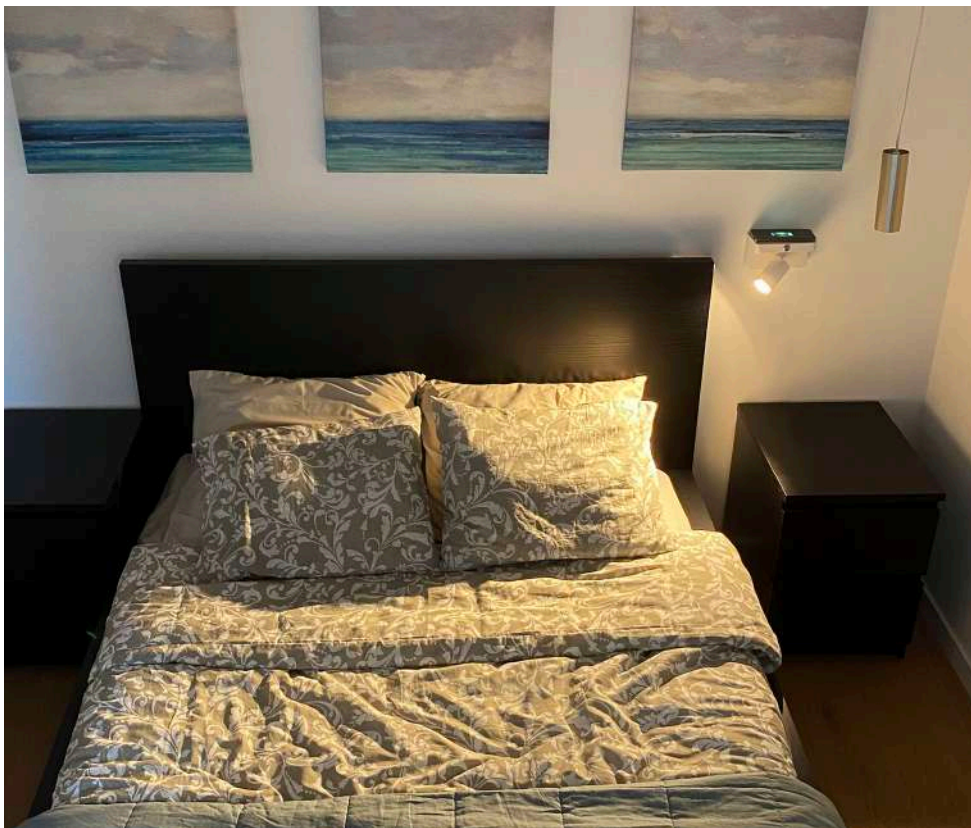

MILO 1

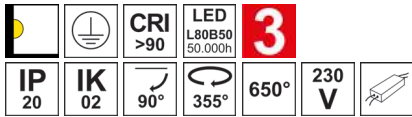

- Applique murale décorative.
- Base apparente avec interrupteur.
- Convertisseur non dimmable intégré dans l'appareil.

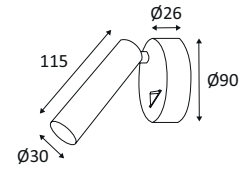

MILO 1	COULEUR	MATIÈRE	P	CCT	LED LUMEN	SYSTEM LUMEN	α	€
WA11205	■ NOIR MAT	ALUMINIUM	5W	3000K	500Lm	405Lm	40°	158,00
WA11230	■ BLANC MAT	ALUMINIUM	5W	3000K	500Lm	450Lm	40°	158,00



NOIR MAT



BLANC MAT

MILO 2

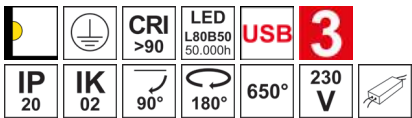

- Applique murale décorative.
- Base apparente avec interrupteur permettant trois niveaux d'éclairage (25%, 50% et 100%) et deux prises USB (5VDC, 2A).
- Convertisseur non dimmable intégré dans l'appareil.

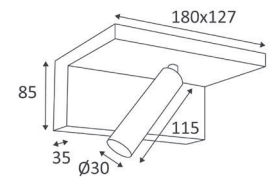

MILO 2	COULEUR	MATIÈRE	P	CCT	LED LUMEN	SYSTEM LUMEN	α	€
WA165WW05	■ NOIR MAT	ALUMINIUM	5W	3000K	500Lm	405Lm	40°	213,00
WA165WW30	■ BLANC MAT	ALUMINIUM	5W	3000K	500Lm	450Lm	40°	213,00



NOIR MAT



BLANC MAT

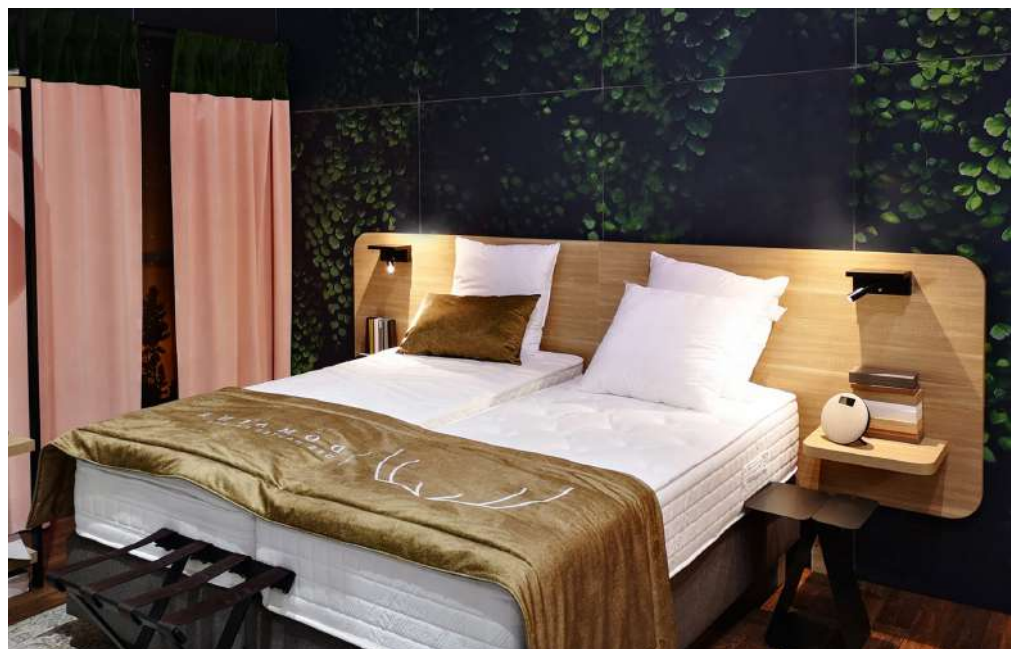



MILO 3

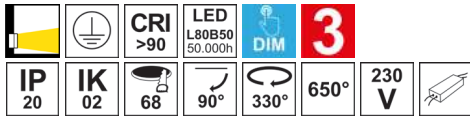

- Applique murale décorative.
- Base semi-encastree.
- Avec interrupteur variateur.
- Livree avec convertisseur dimmable.
- Montage dans un boîtier d'encastrement standard (non fourni).

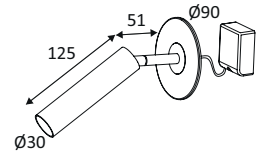

MILO 3	COULEUR	MATIÈRE	P	CCT	LED LUMEN	SYSTEM LUMEN	α	€
WA215SW05	■ NOIR MAT	ALUMINIUM	5W	2700K	460Lm	395Lm	40°	132,00
WA215SW30	■ BLANC MAT	ALUMINIUM	5W	2700K	460Lm	395Lm	40°	132,00
WA215SW63	■ LAITON BROSSÉ	ALUMINIUM	5W	2700K	460Lm	395Lm	40°	137,00



NOIR MAT



BLANC MAT



LAITON BROSSÉ

MILO 4

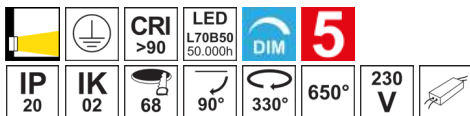

- Applique murale décorative.
- Base semi-encastree.
- Convertisseur dimmable déporté fourni.
- Compatible avec variateur début et fin de phase.
- Montage dans un boîtier d'encastrement standard (non fourni).

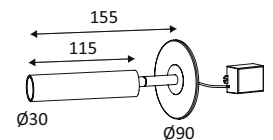

MILO 4	COULEUR	MATIÈRE	P	CCT	LED LUMEN	SYSTEM LUMEN	α	€
WA235SW05	■ NOIR MAT	ALUMINIUM	5W	2700K	465Lm	445Lm	40°	145,00
WA235SW30	■ BLANC MAT	ALUMINIUM	5W	2700K	465Lm	445Lm	40°	145,00
WA235SW63	■ LAITON BROSSÉ	ALUMINIUM	5W	2700K	465Lm	445Lm	40°	150,00



NOIR MAT



BLANC MAT



LAITON BROSSÉ

SOLYA



- Applique murale décorative 2 en 1 pour éclairage d'ambiance et de lecture.
- Eclairage d'ambiance cosy grâce à la technologie dim-to-warm (température de couleur variable de 1800K à 3000K suivant l'intensité de dimming).
- Base apparente avec interrupteur pour la liseuse, 1 prise USB-A et 1 prise USB-C (5VDC, 2A).
- Convertisseurs intégrés dans l'appareil et indépendants permettant de raccorder et contrôler chaque source séparément.
- Eclairage d'ambiance dimmable par coupure de phase.

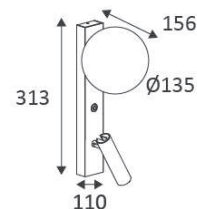

SOLYA	COULEUR	P	CCT	LED LUMEN	SYSTEM LUMEN	€
WA28905 NEW	NOIR MAT	6,3W + 9,6W	3000K + 1800K > 3000K	475Lm (3000K) + 810Lm (3000K)	420Lm (3000K) + 615Lm (3000K)	310,00
WA28930 NEW	BLANC MAT	6,3W + 9,6W	3000K + 1800K > 3000K	475Lm (3000K) + 810Lm (3000K)	420Lm (3000K) + 615Lm (3000K)	310,00
WA28958 NEW	GRIS CANON DE FUSIL	6,3W + 9,6W	3000K + 1800K > 3000K	475Lm (3000K) + 810Lm (3000K)	420Lm (3000K) + 615Lm (3000K)	335,00
WA28961 NEW	LAITON BROSSÉ	6,3W + 9,6W	3000K + 1800K > 3000K	475Lm (3000K) + 810Lm (3000K)	420Lm (3000K) + 615Lm (3000K)	335,00



NOIR MAT



BLANC MAT



GRIS CANON DE FUSIL



LAITON BROSSÉ

SOLYA

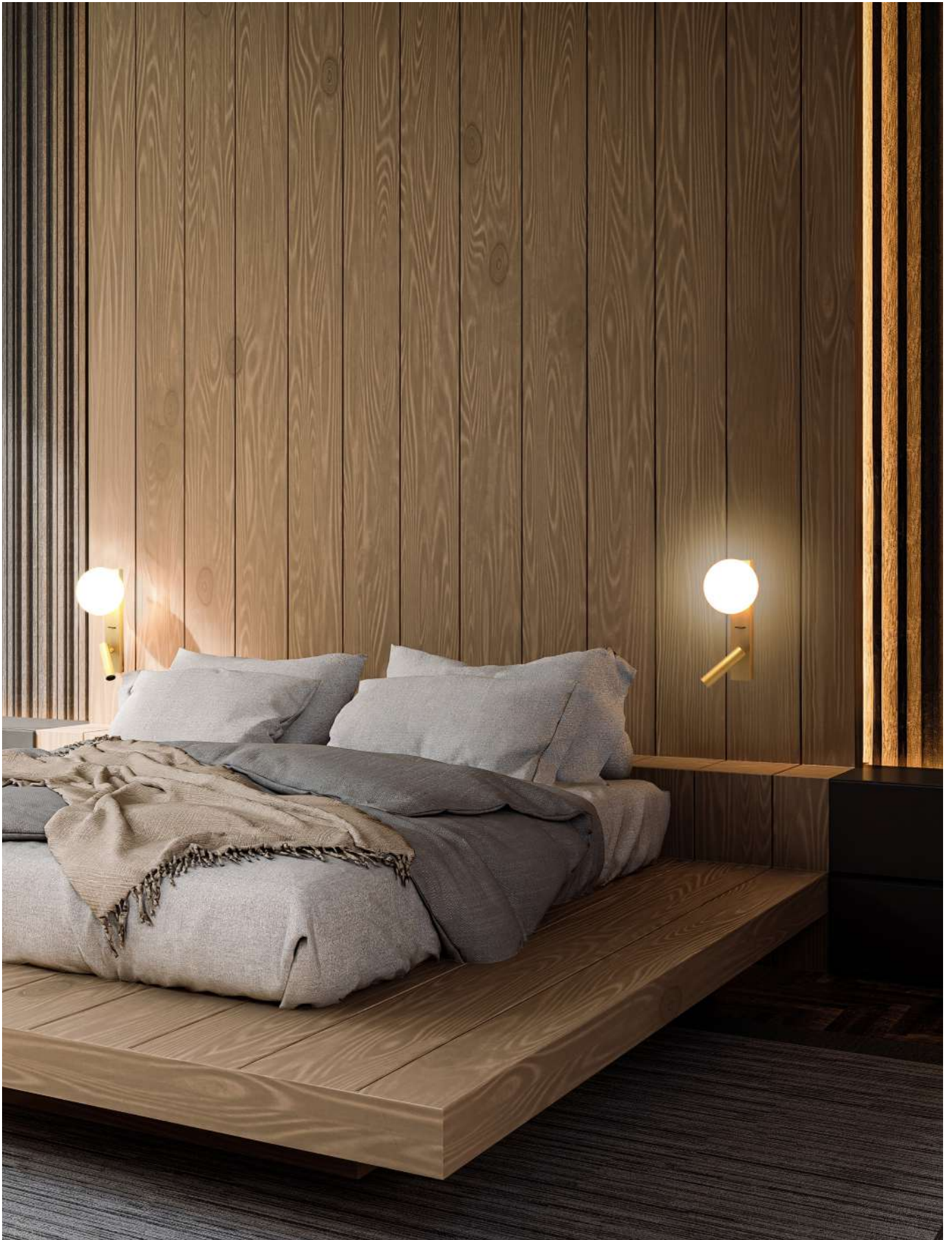

BIXBY





BIXBY

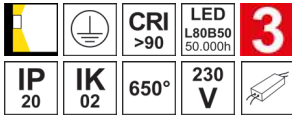

- Applique murale décorative.
- Eclairage «up&down».
- Convertisseur non dimmable intégré dans l'appareil.

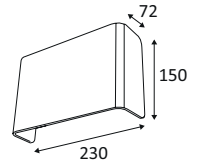

BIXBY	COULEUR	MATIÈRE	P	CCT	LED LUMEN	SYSTEM LUMEN	€
WA12830	BLANC MAT	ALUMINIUM	12W	3000K	1250Lm	755Lm	210,00
WA12841	ALUMINIUM POLI	ALUMINIUM	12W	3000K	1250Lm	755Lm	210,00
WA12840	BOIS GRIS	BOIS	12W	3000K	1250Lm	755Lm	210,00
WA12842	BOIS CLAIR	BOIS	12W	3000K	1250Lm	755Lm	210,00

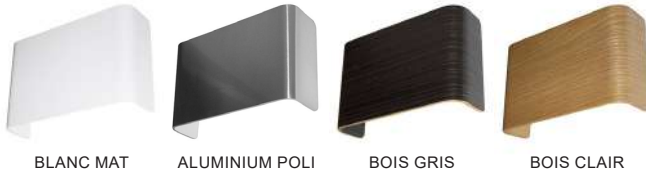

BLANC MAT

ALUMINIUM POLI

BOIS GRIS

BOIS CLAIR



FOLD 2





FOLD 1

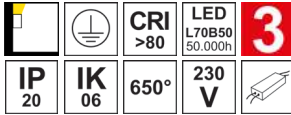

- Applique murale décorative.
- Eclairage indirect.
- Convertisseur non dimmable intégré dans l'appareil.

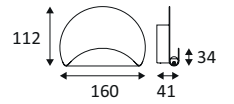

FOLD 1	COULEUR	MATIÈRE	P	CCT	LED LUMEN	SYSTEM LUMEN	€
WA236WW30	BLANC MAT	ALUMINIUM	4W	3000K	540Lm	190Lm	160,00

FOLD 2



- Applique murale décorative.
- Eclairage indirect.
- Convertisseur non dimmable intégré dans l'appareil.

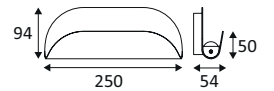

FOLD 2	COULEUR	MATIÈRE	P	CCT	LED LUMEN	SYSTEM LUMEN	€
WA237WW30	BLANC MAT	ALUMINIUM	6,5W	3000K	450Lm	375Lm	185,00

OLYN 1 W

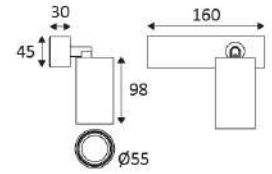

- Applique murale ou plafonnier orientable.
- 3000K, 3500K ou 4000K au choix via un interrupteur à l'arrière du luminaire.
- Convertisseur dimmable intégré dans l'appareil.
- Compatible avec variateur début de phase.
- Très basse luminance grâce à un design d'optique à réflexion totale interne.

OLYN 1 W	COULEUR	MATIÈRE	P	CCT	LED LUMEN	SYSTEM LUMEN	α	€
WA28705 NEW	NOIR MAT	ALUMINIUM	15W	3000K 3500K 4000K	1820Lm (4000K)	1340Lm (4000K)	36°	150,00
WA28730 NEW	BLANC MAT	ALUMINIUM	15W	3000K 3500K 4000K	1820Lm (4000K)	1340Lm (4000K)	36°	150,00
WA28731 NEW	NOIR MAT - BRONZE SATINÉ	ALUMINIUM	15W	3000K 3500K 4000K	1820Lm (4000K)	1340Lm (4000K)	36°	170,00
WA28751 NEW	BLANC MAT - ROSE BROSSÉ	ALUMINIUM	15W	3000K 3500K 4000K	1820Lm (4000K)	1340Lm (4000K)	36°	170,00
WA28756 NEW	BLANC MAT - NICKEL BROSSÉ	ALUMINIUM	15W	3000K 3500K 4000K	1820Lm (4000K)	1340Lm (4000K)	36°	170,00
WA28757 NEW	NOIR MAT - NICKEL BROSSÉ	ALUMINIUM	15W	3000K 3500K 4000K	1820Lm (4000K)	1340Lm (4000K)	36°	170,00
WA28759 NEW	BLANC MAT - OR BROSSÉ	ALUMINIUM	15W	3000K 3500K 4000K	1820Lm (4000K)	1340Lm (4000K)	36°	170,00
WA28765 NEW	BLANC MAT - BRONZE SATINÉ	ALUMINIUM	15W	3000K 3500K 4000K	1820Lm (4000K)	1340Lm (4000K)	36°	170,00
WA28767 NEW	NOIR MAT - ROSE BROSSÉ	ALUMINIUM	15W	3000K 3500K 4000K	1820Lm(4000K)	1340Lm (4000K)	36°	170,00
WA28768 NEW	NOIR MAT - OR BROSSÉ	ALUMINIUM	15W	3000K 3500K 4000K	1820Lm (4000K)	1340Lm (4000K)	36°	170,00

DANS LA MÊME GAMME



OLYN 2 RDX PAGE 99



OLYN 3 T PAGE 280



OLYN 2 C PAGE 204



OLYN 2 P PAGE 229



OLYN 1 RDX PAGE 98



OLYN 1 P PAGE 228



OLYN 1 W

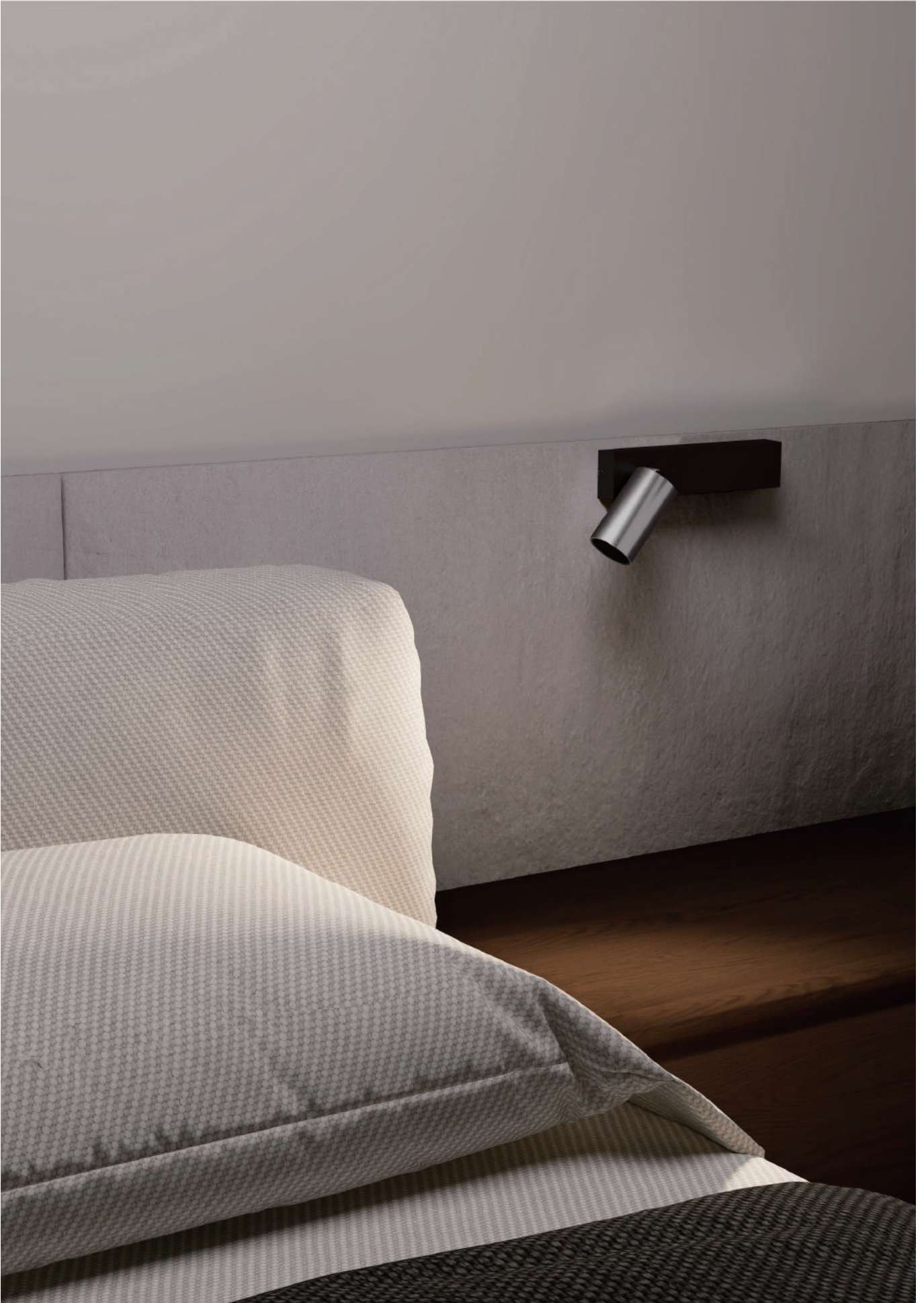

RETI W

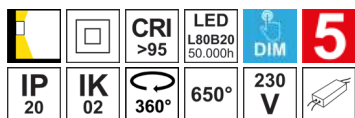

- Applique murale décorative.
- Eclairage «up&down».
- Faisceaux lumineux précisément dessinés grâce à des lentilles en verre de haute qualité.
- Avec 2 interrupteurs variateurs, sources réglables individuellement.
- Convertisseur dimmable intégré dans l'appareil.

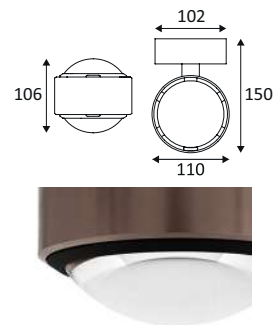

RETI W	COULEUR	MATIÈRE	P	CCT	LED LUMEN	SYSTEM LUMEN	α	€
WA264WW05	■ NOIR MAT	ALUMINIUM	18W	3000K	800Lm	1450Lm	80°	460,00
WA264WW31	■ NOIR MAT - BRONZE SATINÉ	ALUMINIUM	18W	3000K	800Lm	1450Lm	80°	460,00
WA264WW30	■ BLANC MAT	ALUMINIUM	18W	3000K	800Lm	1450Lm	80°	460,00



NOIR MAT

OR BROSSÉ

BLANC MAT

DANS LA MÊME GAMME



RETI 2 RX PAGE 104



RETI 1 RX PAGE 104



RETI P PAGE 236



RETI W

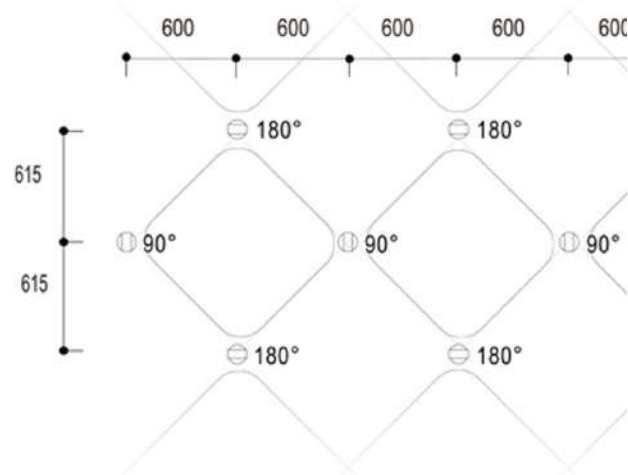
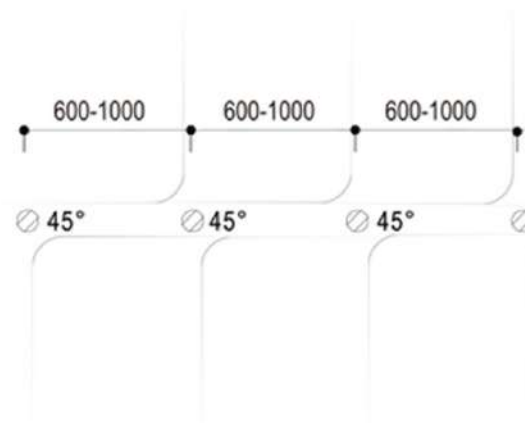

- Déclinable en applique, suspension ou semi-encastré.
- Faisceau lumineux précisément dessiné donnant un effet graphique.
- Finition de qualité supérieure.

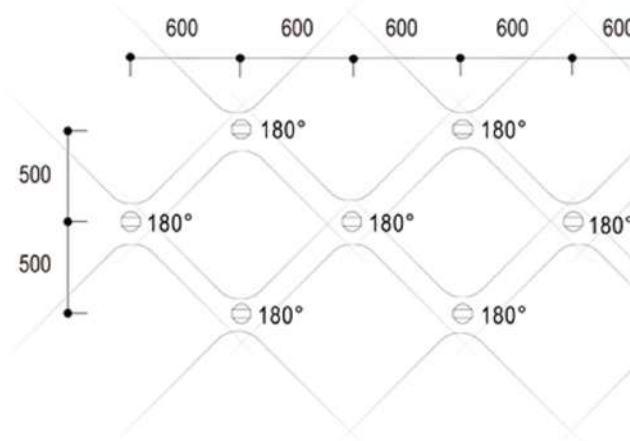

KAVA

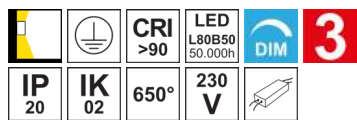

- Applique murale décorative.
- Eclairage «up&down».
- Convertisseur dimmable intégré dans l'appareil.

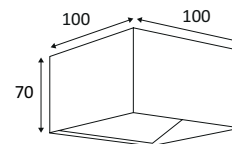

KAVA	COULEUR	MATIÈRE	P	CCT	LED LUMEN	SYSTEM LUMEN	€
WA209WW18	NOIR MAT - DORÉ	ALUMINIUM	5W	3000K	500Lm	280Lm	165,00
KU147916	BLANC MAT	ALUMINIUM	5W	3000K	500Lm	485Lm	165,00
WA209WW80	BLANC MAT - DORÉ	ALUMINIUM	5W	3000K	500Lm	340Lm	165,00



NOIR MAT - DORÉ

BLANC MAT

BLANC MAT - DORÉ





FULLA

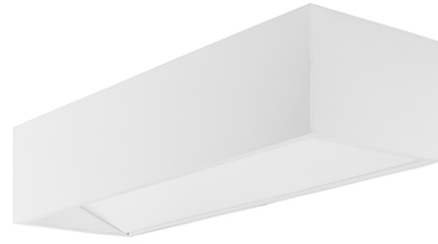
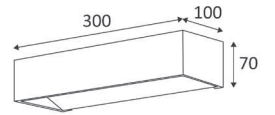
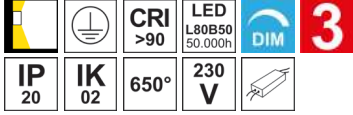

- Applique murale décorative.
- Eclairage «up&down».
- Convertisseur dimmable intégré dans l'appareil.
- Compatible avec variateur début et fin de phase.

FULLA	COULEUR	MATIÈRE	P	CCT	LED LUMEN	SYSTEM LUMEN	€
WA169WW30	BLANC MAT	ALUMINIUM	15W	3000K	1900Lm	1430Lm	240,00



GLAM 90

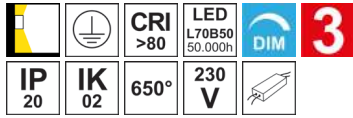

- Applique murale décorative.
- Eclairage «up&down».
- Convertisseur dimmable intégré dans l'appareil.
- Compatible avec variateur début et fin de phase.

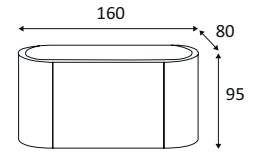

GLAM 90	COULEUR	MATIÈRE	P	CCT	LED LUMEN	SYSTEM LUMEN	€
WA175WW18	NOIR MAT - DORÉ	ALUMINIUM	10W	3000K	1010Lm	450Lm	170,00
WA175WW17	NOIR MAT - ARGENT	ALUMINIUM	10W	3000K	1010Lm	680Lm	170,00



NOIR MAT - DORÉ NOIR MAT - ARGENT

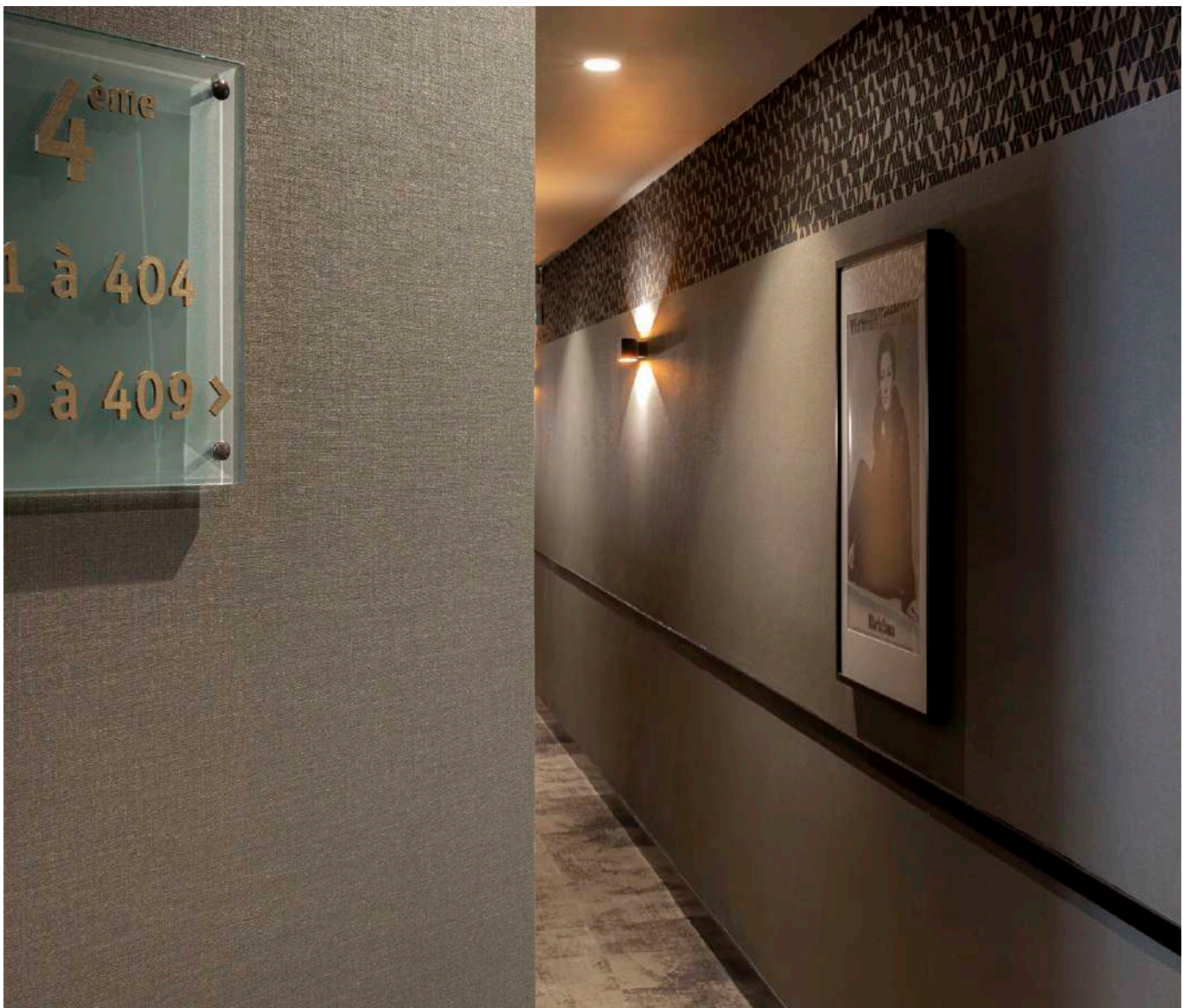



GLAM 250

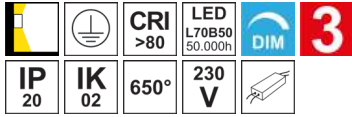

- Applique murale décorative.
- Eclairage «up&down».
- Convertisseur dimmable intégré dans l'appareil.
- Compatible avec variateur début et fin de phase.

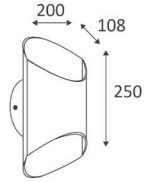

GLAM 250	COULEUR	MATIÈRE	P	CCT	LED LUMEN	SYSTEM LUMEN	€
WA176WW18	NOIR MAT - DORÉ	ALUMINIUM	12W	3000K	1010Lm	360Lm	208,00
WA176WW17	NOIR MAT - ARGENT	ALUMINIUM	12W	3000K	1010Lm	520Lm	208,00



NOIR MAT - DORÉ NOIR MAT - ARGENT



MALTA 1

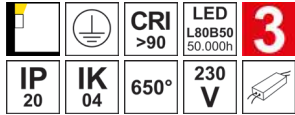

- Applique murale décorative.
- Eclairage indirect.
- Convertisseur non dimmable intégré dans l'appareil.

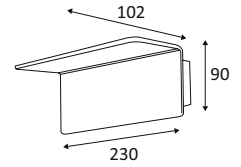

MALTA 1	COULEUR	MATIÈRE	P	CCT	LED LUMEN	SYSTEM LUMEN	€
WA12930	BLANC MAT	ALUMINIUM	19W	3000K	2520Lm	2365Lm	248,00

MALTA 2

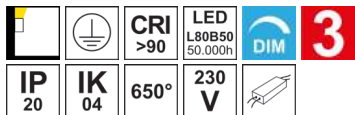

- Applique murale décorative.
- Eclairage indirect.
- Convertisseur dimmable intégré dans l'appareil.
- Compatible avec variateur fin de phase.

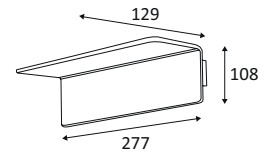

MALTA 2	COULEUR	MATIÈRE	P	CCT	LED LUMEN	SYSTEM LUMEN	€
WA164WW30	BLANC MAT	ALUMINIUM	30W	3000K	3550Lm	3370Lm	284,00



LONGA

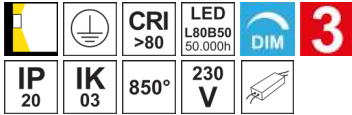

- Applique murale décorative.
- Eclairage «up&down».
- Convertisseur dimmable intégré dans l'appareil.
- Compatible avec variateur début et fin de phase.

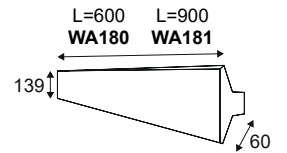

LONGA	COULEUR	MATIÈRE	P	CCT	L(MM)	LED LUMEN	SYSTEM LUMEN	€
WA180WW05	NOIR MAT	ALUMINIUM	24W	3000K	600	2x2800Lm	5320Lm	295,00
WA180WW30	BLANC MAT	ALUMINIUM	24W	3000K	600	2x2800Lm	5320Lm	295,00
WA181WW05	NOIR MAT	ALUMINIUM	30W	3000K	900	2x3300Lm	6200Lm	360,00
WA181WW30	BLANC MAT	ALUMINIUM	30W	3000K	900	2x3300Lm	6200Lm	360,00

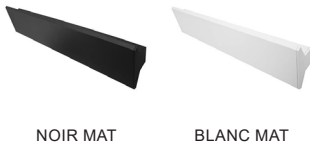

NOIR MAT

BLANC MAT







PLANK 1

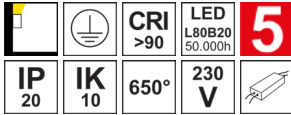

- Applique murale décorative.
- Diffuseur en polycarbonate opalin.
- Eclairage indirect.
- Convertisseur non dimmable intégré dans l'appareil.

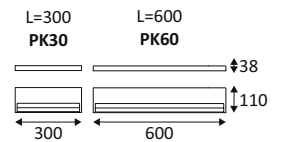

PLANK 1	COULEUR	MATIÈRE	P	CCT	L(MM)	LED LUMEN	SYSTEM LUMEN	α	€
PK30/1A/3K/W	BLANC MAT	ALUMINIUM	20W	3000K	300	2520Lm	1760Lm	110°	184,00
PK30/1A/4K/W	BLANC MAT	ALUMINIUM	20W	4000K	300	2730Lm	1910Lm	110°	184,00
PK60/1A/3K/W	BLANC MAT	ALUMINIUM	40W	3000K	600	5400Lm	3775Lm	110°	284,00
PK60/1A/4K/W	BLANC MAT	ALUMINIUM	40W	4000K	600	5850Lm	4090Lm	110°	284,00



BLANC MAT

BLANC MAT

PLANK 2

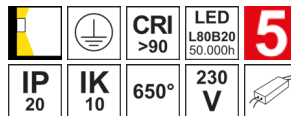

- Applique murale décorative.
- Diffuseurs en polycarbonate opalin.
- Eclairage direct/indirect.
- Convertisseur non dimmable intégré dans l'appareil.

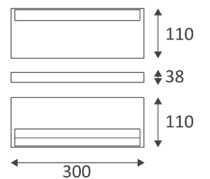

PLANK 2	COULEUR	MATIÈRE	P	CCT	L(MM)	LED LUMEN	SYSTEM LUMEN	α	€
PK30/2A/3K/W	BLANC MAT	ALUMINIUM	32W	3000K	300	2X1980Lm	2210Lm	110° 110°	195,00
PK30/2A/4K/W	BLANC MAT	ALUMINIUM	32W	4000K	300	2X2145Lm	2400Lm	110° 110°	195,00
PK60/2A/3K/W	BLANC MAT	ALUMINIUM	64W	3000K	600	2X4030Lm	5640Lm	110° 110°	310,00
PK60/2A/4K/W	BLANC MAT	ALUMINIUM	64W	4000K	600	2X4370Lm	6110Lm	110° 110°	310,00

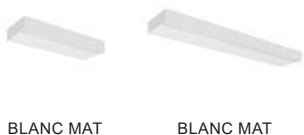

BLANC MAT

BLANC MAT

PLAFONNIERS

ALBA S GU10

- Plafonnier carré orientable.

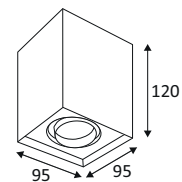

ALBA S GU10	COULEUR	MATIÈRE	L(MM)	DOUILLE	LAMPE	WATT MAX	€
WA19605	■ NOIR MAT	ALUMINIUM	95	GU10	PAR16 LED	10W	81,00
WA19630	□ BLANC MAT	ALUMINIUM	95	GU10	PAR16 LED	10W	81,00



NOIR MAT



BLANC MAT

ALBA R GU10

- Plafonnier rond orientable.

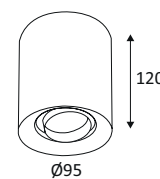

ALBA R GU10	COULEUR	MATIÈRE	DOUILLE	LAMPE	WATT MAX	€
WA19505	■ NOIR MAT	ALUMINIUM	GU10	PAR16 LED	10W	63,00
WA19530	□ BLANC MAT	ALUMINIUM	GU10	PAR16 LED	10W	63,00



NOIR MAT



BLANC MAT



ALBA S GU10



LUPO 1 GU10

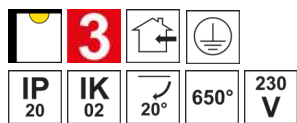

- Plafonnier carré orientable.

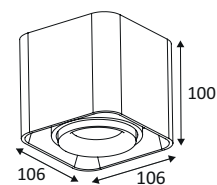

LUPO 1 GU10	COULEUR	MATIÈRE	L(MM)	DOUILLE	LAMPE	WATT MAX	€
WA20305	■ NOIR MAT	ALUMINIUM	106	GU10	PAR16 LED	10W	81,00
WA20318	■ NOIR - DORÉ	ALUMINIUM	106	GU10	PAR16 LED	10W	81,00
WA20330	■ BLANC MAT	ALUMINIUM	106	GU10	PAR16 LED	10W	81,00



NOIR MAT



NOIR - DORÉ



BLANC MAT

MANYL 2

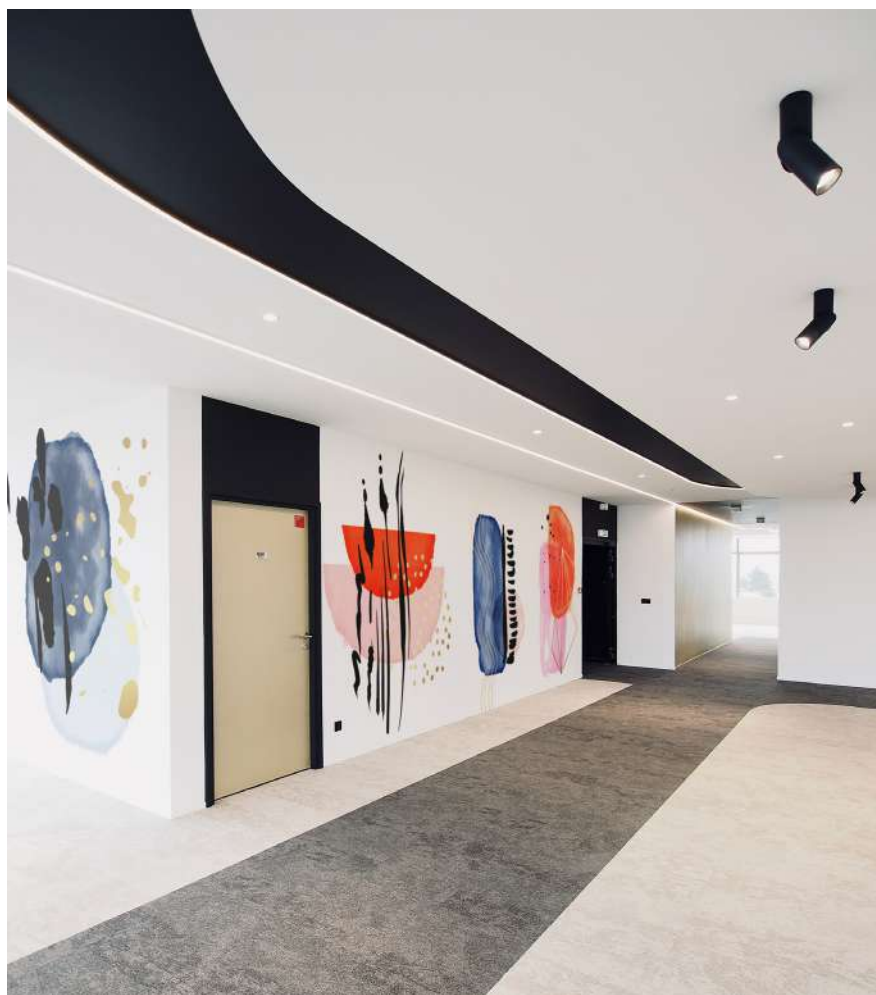



MANYL 2 GU10

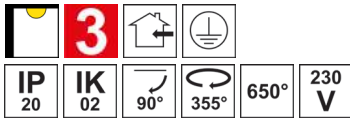

- Plafonnier rond orientable.

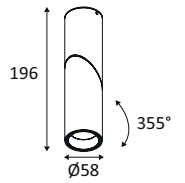

MANYL 2 GU10	COULEUR	MATIÈRE	DOUILLE	LAMPE	WATT MAX	€
WA20205	■ NOIR MAT	ALUMINIUM	GU10	PAR16 LED	10W	118,00
WA20230	■ BLANC MAT	ALUMINIUM	GU10	PAR16 LED	10W	118,00



NOIR MAT



BLANC MAT

MANYL 2

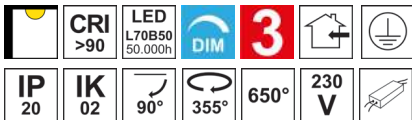

- Plafonnier rond orientable.
- Convertisseur dimmable intégré dans l'appareil.
- Compatible avec variateur début et fin de phase.

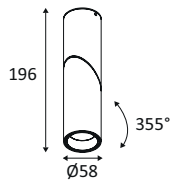

MANYL 2	COULEUR	MATIÈRE	P	CCT	LED LUMEN	SYSTEM LUMEN	α	€
WA210WW16	■ NOIR MAT	ALUMINIUM	11W	3000K	1180Lm	940Lm	36°	184,00
WA210WW21	■ BLANC MAT	ALUMINIUM	11W	3000K	1180Lm	940Lm	36°	184,00



NOIR MAT



BLANC MAT

MOLY GU10

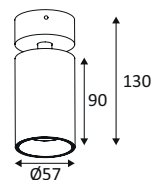
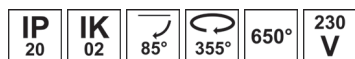

MOLY GU10	COULEUR	MATIÈRE	DOUILLE	LAMPE	WATT MAX	€
WA19405	■ NOIR MAT	ALUMINIUM	GU10	PAR16 LED	10W	56,00
WA19430	■ BLANC MAT	ALUMINIUM	GU10	PAR16 LED	10W	56,00



NOIR MAT

BLANC MAT

NOLY GU10

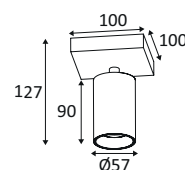
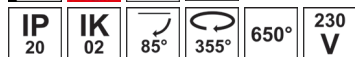

- Applique murale ou plafonnier orientable.

NOLY GU10	COULEUR	MATIÈRE	L(MM)	DOUILLE	LAMPE	WATT MAX	€
WA19705	■ NOIR MAT	ALUMINIUM	100	GU10	PAR16 LED	10W	55,00
WA19730	■ BLANC MAT	ALUMINIUM	100	GU10	PAR16 LED	10W	55,00



NOIR MAT

BLANC MAT





YUKO GU10

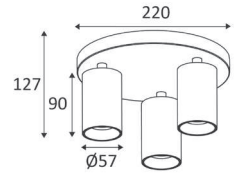

- Plafonnier rond orientable.



YUKO GU10	COULEUR	MATIÈRE	DOUILLE	LAMPE	WATT MAX	€
WA19805	 NOIR MAT	ALUMINIUM	GU10	PAR16 LED	3X10W	99,00
WA19830	 BLANC MAT	ALUMINIUM	GU10	PAR16 LED	3X10W	99,00



NOIR MAT



BLANC MAT

YUKO GU10





MOLY GU10



HAPPY 2



RIVA 3 GU10



RIVA 2 GU10





RIVA 2 GU10



- Applique murale ou plafonnier orientable.

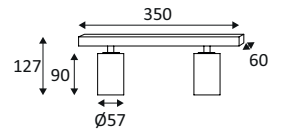

RIVA 2 GU10	COULEUR	MATIÈRE	L(MM)	DOUILLE	LAMPE	WATT MAX	€
WA19905	■ NOIR MAT	ALUMINIUM	350	GU10	PAR16 LED	2X10W	91,00
WA19930	■ BLANC MAT	ALUMINIUM	350	GU10	PAR16 LED	2X10W	91,00



NOIR MAT



BLANC MAT

RIVA 3 GU10



- Applique murale ou plafonnier orientable.

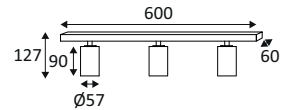

RIVA 3 GU10	COULEUR	MATIÈRE	L(MM)	DOUILLE	LAMPE	WATT MAX	€
WA20005	■ NOIR MAT	ALUMINIUM	600	GU10	PAR16 LED	3X10W	123,00
WA20030	■ BLANC MAT	ALUMINIUM	600	GU10	PAR16 LED	3X10W	123,00



NOIR MAT



BLANC MAT

RIVA 4 GU10

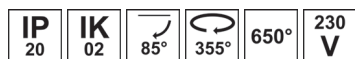

- Applique murale ou plafonnier orientable.



RIVA 4 GU10	COULEUR	MATIÈRE	L(MM)	DOUILLE	LAMPE	WATT MAX	€
WA20105	■ NOIR MAT	ALUMINIUM	800	GU10	PAR16 LED	4X10W	160,00
WA20130	■ BLANC MAT	ALUMINIUM	800	GU10	PAR16 LED	4X10W	160,00



NOIR MAT

BLANC MAT





EVA 62 R

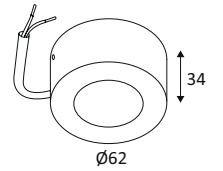
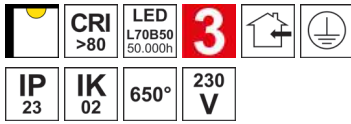

- Spot apparent rond.
- Ne nécessite pas de convertisseur.
- Non dimmable.

EVA 62 R	COULEUR	MATIÈRE	P	CCT	LED LUMEN	SYSTEM LUMEN	α	€
DW1120R05	■ NOIR MAT	ALUMINIUM	8W	3000K	455Lm	335Lm	38°	82,00
DW1120R30	■ BLANC MAT	ALUMINIUM	8W	3000K	455Lm	335Lm	38°	82,00



NOIR MAT



BLANC MAT



OBIA 1 C



- Applique murale ou plafonnier rond orientable.
- Tête inclinable jusqu'à 45°.
- CCT (2700K, 3000K ou 4000K) et puissance (6 ou 9W) au choix via un interrupteur dans le luminaire.
- Convertisseur dimmable par coupure de phase intégré dans le luminaire.

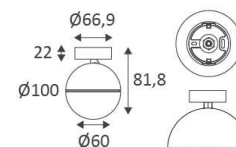

OBIA 1 C	COULEUR	MATIÈRE	P	CCT	LED LUMEN	SYSTEM LUMEN	α	€
WA29005 NEW	NOIR MAT	FONTE D'ALUMINIUM	6-9W	2700K 3000K 4000K	950Lm (4000K)	710Lm (4000K)	150°	190,00
WA29030 NEW	BLANC MAT	FONTE D'ALUMINIUM	6-9W	2700K 3000K 4000K	950Lm (4000K)	710Lm (4000K)	150°	190,00



NOIR MAT



BLANC MAT

OBIA 2 C



- Applique murale ou plafonnier rond orientable.
- Tête inclinable jusqu'à 45°.
- CCT (2700K, 3000K ou 4000K) et puissance (6 ou 9W) au choix via un interrupteur dans le luminaire.
- Convertisseur dimmable par coupure de phase intégré dans le luminaire.

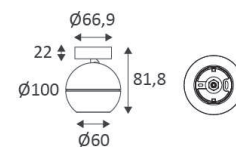

OBIA 2 C	COULEUR	MATIÈRE	P	CCT	LED LUMEN	SYSTEM LUMEN	α	€
WA29105 NEW	NOIR MAT	FONTE D'ALUMINIUM	6-9W	2700K 3000K 4000K	950Lm (4000K)	755Lm (4000K)	60°	200,00
WA29108 NEW	NOIR MAT - CHAMPAGNE	FONTE D'ALUMINIUM	6-9W	2700K 3000K 4000K	950Lm (4000K)	755Lm (4000K)	60°	210,00
WA29130 NEW	BLANC MAT	FONTE D'ALUMINIUM	6-9W	2700K 3000K 4000K	950Lm (4000K)	755Lm (4000K)	60°	200,00
WA29135 NEW	NOIR MAT - BLANC MAT	FONTE D'ALUMINIUM	6-9W	2700K 3000K 4000K	950Lm (4000K)	755Lm (4000K)	60°	210,00
WA29149 NEW	BLANC MAT - CHAMPAGNE	FONTE D'ALUMINIUM	6-9W	2700K 3000K 4000K	950Lm (4000K)	755Lm (4000K)	60°	210,00
WA29181 NEW	BLANC MAT - NOIR	FONTE D'ALUMINIUM	6-9W	2700K 3000K 4000K	950Lm (4000K)	755Lm (4000K)	60°	210,00



NOIR MAT



NOIR MAT - CHAMPAGNE



BLANC MAT



NOIR MAT - BLANC MAT



BLANC MAT - CHAMPAGNE



BLANC MAT - NOIR



OBIA 2 C



HAPPY 1

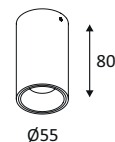

- Plafonnier rond fixe.
- Convertisseur dimmable intégré dans l'appareil.

HAPPY 1	COULEUR	MATIÈRE	P	CCT	LED LUMEN	SYSTEM LUMEN	α	€
WA238WW05	■ NOIR MAT	ALUMINIUM	7W	3000K	600Lm	435Lm	40°	110,00
WA238WW08	■ NOIR MAT - CHAMPAGNE	ALUMINIUM	7W	3000K	600Lm	435Lm	40°	117,00
WA238WW17	■ NOIR MAT - ARGENT	ALUMINIUM	7W	3000K	600Lm	435Lm	40°	117,00
WA238WW23	■ NOIR MAT - CHROME NOIR	ALUMINIUM	7W	3000K	600Lm	435Lm	40°	117,00
WA238WW30	■ BLANC MAT	ALUMINIUM	7W	3000K	600Lm	435Lm	40°	110,00
WA238WW49	■ BLANC MAT - CHAMPAGNE	ALUMINIUM	7W	3000K	600Lm	435Lm	40°	117,00
WA238WW53	■ BLANC MAT - ARGENT	ALUMINIUM	7W	3000K	600Lm	435Lm	40°	117,00
WA238WW22	■ BLANC MAT - CHROME NOIR	ALUMINIUM	7W	3000K	600Lm	435Lm	40°	117,00



NOIR MAT



NOIR MAT - CHAMPAGNE



NOIR MAT - ARGENT



NOIR MAT - CHROME NOIR



BLANC MAT



BLANC MAT - CHAMPAGNE



BLANC MAT - ARGENT



BLANC MAT - CHROME NOIR





HAPPY 2

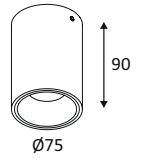

- Plafonnier rond fixe.
- Convertisseur dimmable intégré dans l'appareil.

HAPPY 2	COULEUR	MATIÈRE	P	CCT	LED LUMEN	SYSTEM LUMEN	α	€
WA239WW05	NOIR MAT	ALUMINIUM	13W	3000K	1155Lm	855Lm	40°	131,00
WA239WW08	NOIR MAT - CHAMPAGNE	ALUMINIUM	13W	3000K	1155Lm	855Lm	40°	143,00
WA239WW17	NOIR MAT - ARGENT	ALUMINIUM	13W	3000K	1155Lm	855Lm	40°	143,00
WA239WW23	NOIR MAT - CHROME NOIR	ALUMINIUM	13W	3000K	1155Lm	855Lm	40°	143,00
WA239WW30	BLANC MAT	ALUMINIUM	13W	3000K	1155Lm	855Lm	40°	131,00
WA239WW49	BLANC MAT - CHAMPAGNE	ALUMINIUM	13W	3000K	1155Lm	855Lm	40°	143,00
WA239WW53	BLANC MAT - ARGENT	ALUMINIUM	13W	3000K	1155Lm	855Lm	40°	143,00
WA239WW22	BLANC MAT - CHROME NOIR	ALUMINIUM	13W	3000K	1155Lm	855Lm	40°	143,00



NOIR MAT



NOIR MAT - CHAMPAGNE



NOIR MAT - ARGENT



NOIR MAT - CHROME NOIR



BLANC MAT



BLANC MAT - CHAMPAGNE



BLANC MAT - ARGENT



BLANC MAT - CHROME NOIR

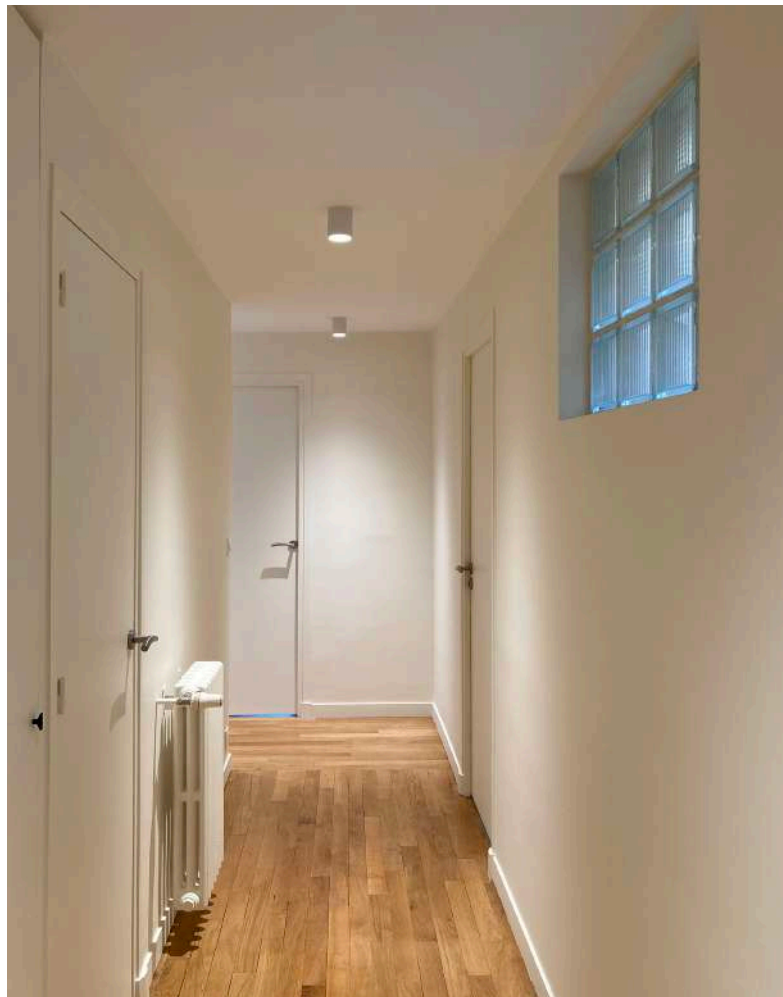

HAPPY 3



- Plafonnier rond fixe.
- Convertisseur dimmable intégré dans l'appareil.

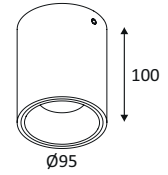

HAPPY 3	COULEUR	MATIÈRE	P	CCT	LED LUMEN	SYSTEM LUMEN	α	€
WA240WW05	■ NOIR MAT	ALUMINIUM	18W	3000K	1570Lm	1170Lm	40°	153,00
WA240WW08	■ NOIR MAT - CHAMPAGNE	ALUMINIUM	18W	3000K	1570Lm	1170Lm	40°	166,00
WA240WW17	■ NOIR MAT - ARGENT	ALUMINIUM	18W	3000K	1570Lm	1170Lm	40°	166,00
WA240WW23	■ NOIR MAT - CHROME NOIR	ALUMINIUM	18W	3000K	1570Lm	1170Lm	40°	166,00
WA240WW30	■ BLANC MAT	ALUMINIUM	18W	3000K	1570Lm	1170Lm	40°	153,00
WA240WW49	■ BLANC MAT - CHAMPAGNE	ALUMINIUM	18W	3000K	1570Lm	1170Lm	40°	166,00
WA240WW53	■ BLANC MAT - ARGENT	ALUMINIUM	18W	3000K	1570Lm	1170Lm	40°	166,00
WA240WW22	■ BLANC MAT - CHROME NOIR	ALUMINIUM	18W	3000K	1570Lm	1170Lm	40°	166,00



NOIR MAT



NOIR MAT - CHAMPAGNE



NOIR MAT - ARGENT



NOIR MAT - CHROME NOIR



BLANC MAT



BLANC MAT - CHAMPAGNE



BLANC MAT - ARGENT



BLANC MAT - CHROME NOIR





HAPPY 3

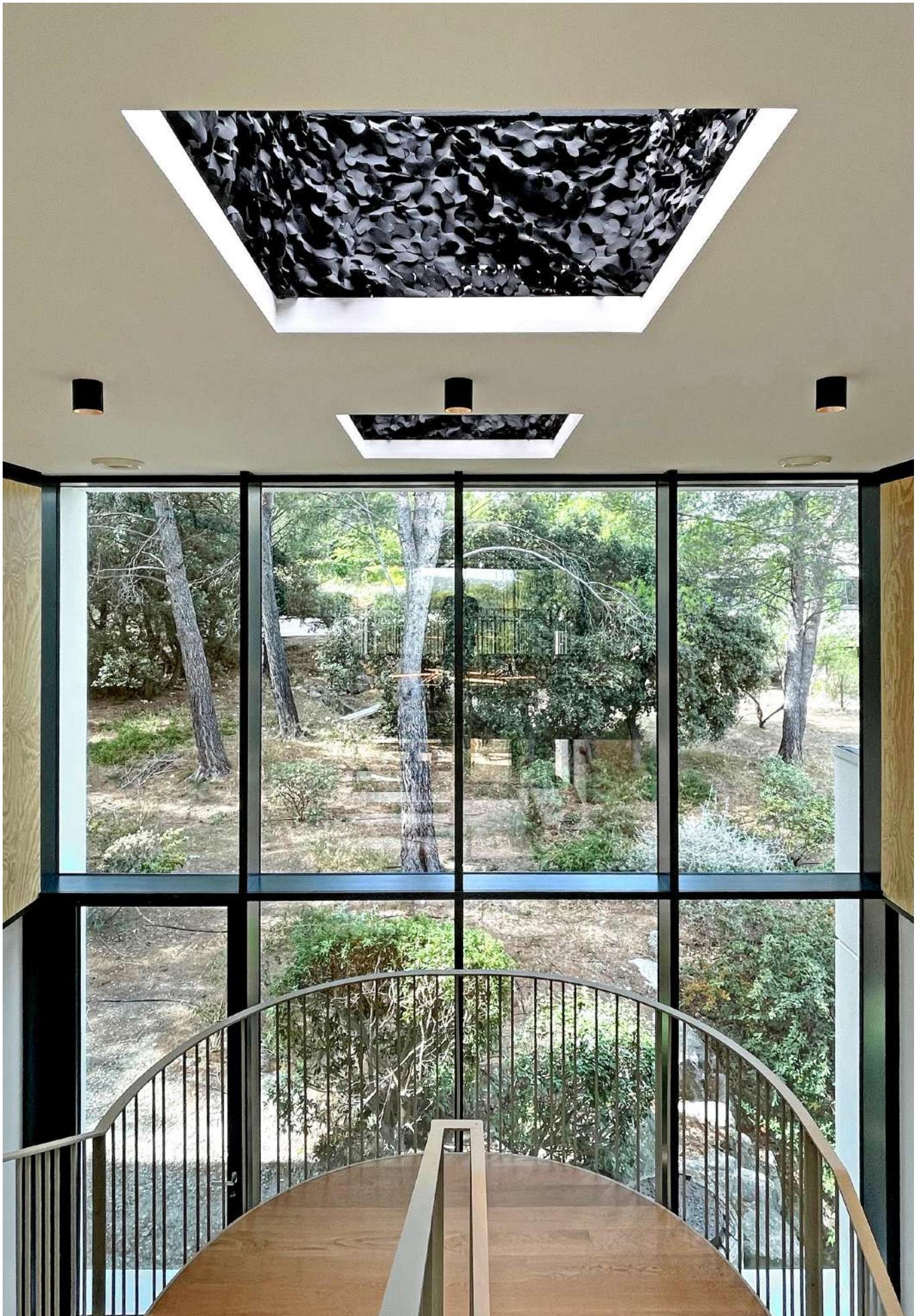

AUREA 1 C

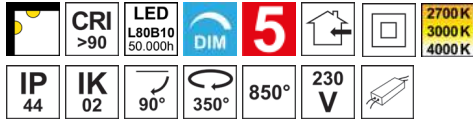

- Applique murale ou plafonnier rond orientable.
- 2700K, 3000K ou 4000K au choix via un interrupteur à l'arrière du luminaire.
- Convertisseur dimmable intégré dans l'appareil.
- Compatible avec variateur début de phase.



AUREA 1 C	COULEUR	MATIÈRE	P	CCT	LED LUMEN	SYSTEM LUMEN	α	€
WA25605	NOIR MAT	ALUMINIUM	6W	2700K 3000K 4000K	715Lm (4000K)	550Lm (4000K)	38°	100,00
WA25608	NOIR MAT - CHAMPAGNE	ALUMINIUM	6W	2700K 3000K 4000K	715Lm (4000K)	550Lm (4000K)	38°	111,00
WA25683	NOIR MAT - ROSE	ALUMINIUM	6W	2700K 3000K 4000K	715Lm (4000K)	550Lm (4000K)	38°	111,00
WA25630	BLANC MAT	ALUMINIUM	6W	2700K 3000K 4000K	715Lm (4000K)	550Lm (4000K)	38°	100,00
WA25649	BLANC MAT - CHAMPAGNE	ALUMINIUM	6W	2700K 3000K 4000K	715Lm (4000K)	550Lm (4000K)	38°	111,00
WA25682	BLANC MAT - ROSE	ALUMINIUM	6W	2700K 3000K 4000K	715Lm (4000K)	550Lm (4000K)	38°	111,00



NOIR MAT



NOIR MAT - CHAMPAGNE



NOIR MAT - ROSE



BLANC MAT



BLANC MAT - CHAMPAGNE



BLANC MAT - ROSE



DANS LA MÊME GAMME



AUREA P PAGE 227



AUREA 4 W PAGE 159



AUREA 3 W PAGE 158



AUREA 2 C

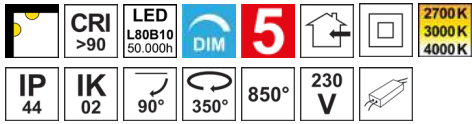

- Applique murale ou plafonnier orientable.
- 2700K, 3000K ou 4000K au choix via un interrupteur à l'arrière du luminaire.
- Convertisseur dimmable intégré dans l'appareil.
- Compatible avec variateur début de phase.



AUREA 2 C	COULEUR	MATIÈRE	P	CCT	L(MM)	LED LUMEN	SYSTEM LUMEN	α	€
WA25705	■ NOIR MAT	ALUMINIUM	12W	2700K 3000K 4000K	250	2X715Lm (4000K)	1100Lm (4000K)	38°	200,00
WA25708	▣ NOIR MAT - CHAMPAGNE	ALUMINIUM	12W	2700K 3000K 4000K	250	2X715Lm (4000K)	1100Lm (4000K)	38°	224,00
WA25783	▣ NOIR MAT - ROSE	ALUMINIUM	12W	2700K 3000K 4000K	250	2X715Lm (4000K)	1100Lm (4000K)	38°	224,00
WA25730	■ BLANC MAT	ALUMINIUM	12W	2700K 3000K 4000K	250	2X715Lm (4000K)	1100Lm (4000K)	38°	200,00
WA25749	▣ BLANC MAT - CHAMPAGNE	ALUMINIUM	12W	2700K 3000K 4000K	250	2X715Lm (4000K)	1100Lm (4000K)	38°	224,00
WA25782	▣ BLANC MAT - ROSE	ALUMINIUM	12W	2700K 3000K 4000K	250	2X715Lm (4000K)	1100Lm (4000K)	38°	224,00



DANS LA MÊME GAMME



AUREA P PAGE 227



AUREA 4 W PAGE 159



AUREA 3 W PAGE 158

OLYN 2 C



- Applique murale ou plafonnier orientable.
- 3000K, 3500K ou 4000K au choix via un interrupteur à l'arrière du luminaire.
- Convertisseur dimmable intégré dans l'appareil.
- Compatible avec variateur début de phase.
- Très basse luminance grâce à un design d'optique à réflexion totale interne.

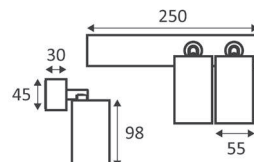

OLYN 2 C	COULEUR	MATIÈRE	P	CCT	LED LUMEN	SYSTEM LUMEN	α	€
WA28865 NEW	BLANC MAT - BRONZE SATINÉ	ALUMINIUM	30W	3000K 3500K 4000K	3640Lm (4000K)	2680Lm (4000K)	36°	220,00
WA28867 NEW	NOIR MAT - ROSE BROSSÉ	ALUMINIUM	30W	3000K 3500K 4000K	3640Lm (4000K)	2680Lm (4000K)	36°	220,00
WA28868 NEW	NOIR MAT - OR BROSSÉ	ALUMINIUM	30W	3000K 3500K 4000K	3640Lm(4000K)	2680Lm (4000K)	36°	220,00
WA28805 NEW	NOIR MAT	ALUMINIUM	30W	3000K 3500K 4000K	3640Lm (4000K)	2680Lm (4000K)	36°	200,00
WA28830 NEW	BLANC MAT	ALUMINIUM	30W	3000K 3500K 4000K	3640Lm (4000K)	2680Lm (4000K)	36°	200,00
WA28831 NEW	NOIR MAT - BRONZE SATINÉ	ALUMINIUM	30W	3000K 3500K 4000K	3640Lm (4000K)	2680Lm (4000K)	36°	220,00
WA28851 NEW	BLANC MAT - ROSE BROSSÉ	ALUMINIUM	30W	3000K 3500K 4000K	3640Lm (4000K)	2680Lm (4000K)	36°	220,00
WA28856 NEW	BLANC MAT - NICKEL BROSSÉ	ALUMINIUM	30W	3000K 3500K 4000K	3640Lm (4000K)	2680Lm (4000K)	36°	220,00
WA28857 NEW	NOIR MAT - NICKEL BROSSÉ	ALUMINIUM	30W	3000K 3500K 4000K	3640Lm (4000K)	2680Lm (4000K)	36°	220,00
WA28859 NEW	BLANC MAT - OR BROSSÉ	ALUMINIUM	30W	3000K 3500K 4000K	3640Lm (4000K)	2680Lm (4000K)	36°	220,00

DANS LA MÊME GAMME



BLANC MAT - BRONZE SATINÉ NOIR MAT - ROSE BROSSÉ NOIR MAT - OR BROSSÉ NOIR MAT BLANC MAT

NOIR MAT - BRONZE SATINÉ BLANC MAT - ROSE BROSSÉ BLANC MAT - NICKEL BROSSÉ NOIR MAT - NICKEL BROSSÉ BLANC MAT - OR BROSSÉ

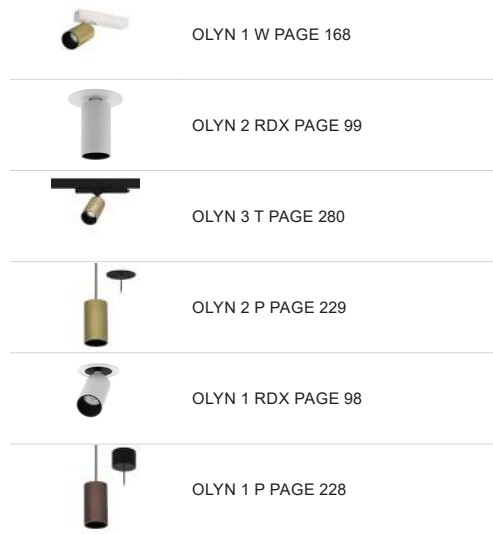

OLYN 1 W PAGE 168

OLYN 2 RDX PAGE 99

OLYN 3 T PAGE 280

OLYN 2 P PAGE 229

OLYN 1 RDX PAGE 98

OLYN 1 P PAGE 228



OLYN 2 C



CLAC 1 MINI

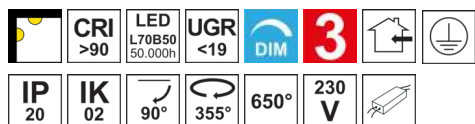

- Applique murale ou plafonnier rond orientable.
- Convertisseur dimmable intégré dans l'appareil.
- Compatible avec variateur fin de phase.

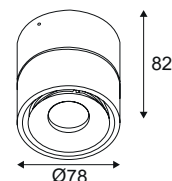

CLAC 1 MINI	COULEUR	MATIÈRE	P	CCT	LED LUMEN	SYSTEM LUMEN	α	€
WA182SW05	■ NOIR MAT	ALUMINIUM	9W	2700K	920Lm	570Lm	38°	135,00
WA182SW30	■ BLANC MAT	ALUMINIUM	9W	2700K	920Lm	640Lm	38°	135,00
WA182WW05	■ NOIR MAT	ALUMINIUM	9W	3000K	930Lm	600Lm	38°	140,00
WA182WW30	■ BLANC MAT	ALUMINIUM	9W	3000K	930Lm	655Lm	38°	140,00



NOIR MAT

BLANC MAT

DANS LA MÊME GAMME



CLIC RDX MINI PAGE 96

CLAC 2 MINI

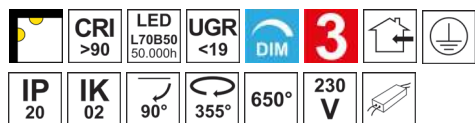

- Applique murale ou plafonnier orientable.
- Convertisseur dimmable intégré dans l'appareil.
- Compatible avec variateur fin de phase.

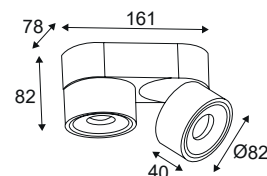

CLAC 2 MINI	COULEUR	MATIÈRE	P	CCT	LED LUMEN	SYSTEM LUMEN	α	€
WA183SW05	■ NOIR MAT	ALUMINIUM	18W	2700K	2X920Lm	1140Lm	38°	195,00
WA183SW30	■ BLANC MAT	ALUMINIUM	18W	2700K	2X920Lm	1230Lm	38°	195,00
WA183WW05	■ NOIR MAT	ALUMINIUM	18W	3000K	2X930Lm	1200Lm	38°	205,00
WA183WW30	■ BLANC MAT	ALUMINIUM	18W	3000K	2X930Lm	1310Lm	38°	205,00



NOIR MAT

BLANC MAT

DANS LA MÊME GAMME



CLIC RDX MINI PAGE 96



CLAC



- Applique murale ou plafonnier rond orientable.
- Convertisseur dimmable intégré dans l'appareil.
- Compatible avec variateur fin de phase.

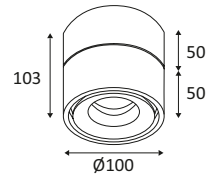

CLAC	COULEUR	MATIÈRE	P	CCT	LED LUMEN	SYSTEM LUMEN	α	€
DO225SW05	NOIR MAT	ALUMINIUM	13W	2700K	1520Lm	865Lm	38°	205,00
DO225SW30	BLANC MAT	ALUMINIUM	13W	2700K	1120Lm	800Lm	38°	205,00
DO225WW05	NOIR MAT	ALUMINIUM	13W	3000K	1570Lm	900Lm	38°	205,00
DO225WW30	BLANC MAT	ALUMINIUM	13W	3000K	1570Lm	1010Lm	38°	205,00
DO225WW64	CUIVRE MAT	ALUMINIUM	13W	3000K	1180Lm	900Lm	38°	205,00



NOIR MAT



BLANC MAT



NOIR MAT



BLANC MAT



CUIVRE MAT



DANS LA MÊME GAMME

CLIC RDX PAGE 96



PIXA 1

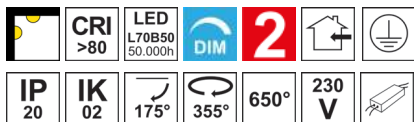

- Applique murale ou plafonnier orientable.
- Convertisseur dimmable intégré dans l'appareil.
- Compatible avec variateur fin de phase.

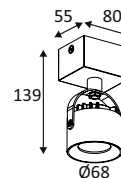

PIXA 1	COULEUR	MATIÈRE	P	CCT	L(MM)	LED LUMEN	SYSTEM LUMEN	α	€
WA13205	■ NOIR MAT	FONTE D'ALUMINIUM	10W	3000K	80	1200Lm	745Lm	38°	185,00
WA13230	■ BLANC MAT	FONTE D'ALUMINIUM	10W	3000K	80	1200Lm	745Lm	38°	185,00



NOIR MAT

BLANC MAT

PIXA 2

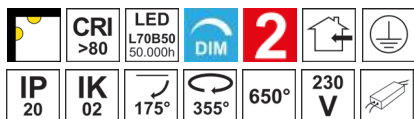

- Applique murale ou plafonnier orientable.
- Convertisseur dimmable intégré dans l'appareil.
- Compatible avec variateur fin de phase.

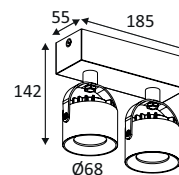

PIXA 2	COULEUR	MATIÈRE	P	CCT	L(MM)	LED LUMEN	SYSTEM LUMEN	α	€
WA13305	■ NOIR MAT	FONTE D'ALUMINIUM	20W	3000K	185	2X1200Lm	1490Lm	38°	297,00
WA13330	■ BLANC MAT	FONTE D'ALUMINIUM	20W	3000K	185	2X1200Lm	1490Lm	38°	297,00



NOIR MAT

BLANC MAT



PIXA 3

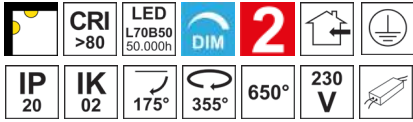

- Applique murale ou plafonnier orientable.
- Convertisseur dimmable intégré dans l'appareil.
- Compatible avec variateur fin de phase.

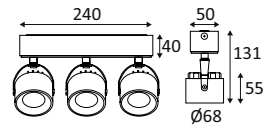

PIXA 3	COULEUR	MATIÈRE	P	CCT	L(MM)	LED LUMEN	SYSTEM LUMEN	α	€
WA13405	■ NOIR MAT	FONTE D'ALUMINIUM	30W	3000K	240	3X1200Lm	2230Lm	38°	430,00
WA13430	■ BLANC MAT	FONTE D'ALUMINIUM	30W	3000K	240	3X1200Lm	2230Lm	38°	430,00



NOIR MAT



BLANC MAT

PIXA 2



TIPO 1 C

- Plafonnier extra-plat rond.
- Ne nécessite pas de convertisseur.
- Non dimmable.

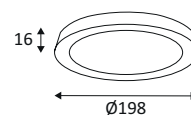

TIPO 1 C	COULEUR	MATIÈRE	P	CCT	LED LUMEN	SYSTEM LUMEN	α	€
DO263WW30	BLANC MAT	COMPOSITE	18W	3000K	1350Lm	1000Lm	110°	81,00
DO263NW30	BLANC MAT	COMPOSITE	18W	4000K	1400Lm	1040Lm	110°	81,00

TIPO 2 C

- Plafonnier extra-plat rond.
- Ne nécessite pas de convertisseur.
- Non dimmable.

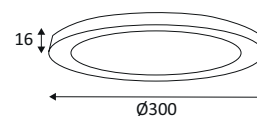

TIPO 2 C	COULEUR	MATIÈRE	P	CCT	LED LUMEN	SYSTEM LUMEN	α	€
WA179WW30	BLANC MAT	COMPOSITE	24W	3000K	2700Lm	1760Lm	110°	94,00
WA179NW30	BLANC MAT	COMPOSITE	24W	4000K	2100Lm	1620Lm	110°	94,00



TIPO 2 C



HULA C

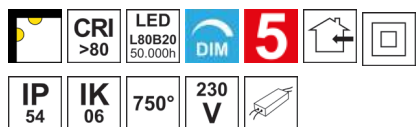

- Applique murale ou plafonnier décoratif.
- Eclairage direct diffus via l'anneau externe et indirect via le réflecteur au design ondulé créant une ambiance agréable.
- Convertisseur dimmable intégré dans l'appareil.
- Compatible avec variateur début et fin de phase.
- Entrée de câble supérieure ou latérale.

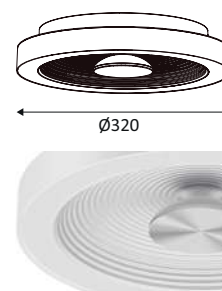

HULA C	COULEUR	MATIÈRE	P	CCT	LED LUMEN	SYSTEM LUMEN	α	€
AIN3KCLBKWH	NOIR MAT - BLANC MAT	PLASTIQUE	18W	3000K	1850Lm	1000Lm	120°	125,00
AIN3KCLBKGD	NOIR MAT - DORÉ	PLASTIQUE	18W	3000K	1850Lm	1000Lm	120°	125,00
AIN3KCLWHWH	BLANC MAT	PLASTIQUE	18W	3000K	1850Lm	1000Lm	120°	125,00
AIN3KCLWHGD	BLANC MAT - DORÉ	PLASTIQUE	18W	3000K	1850Lm	1000Lm	120°	125,00

NOIR MAT - BLANC
MAT

NOIR MAT - DORÉ

BLANC MAT

BLANC MAT - DORÉ

DANS LA MÊME GAMME

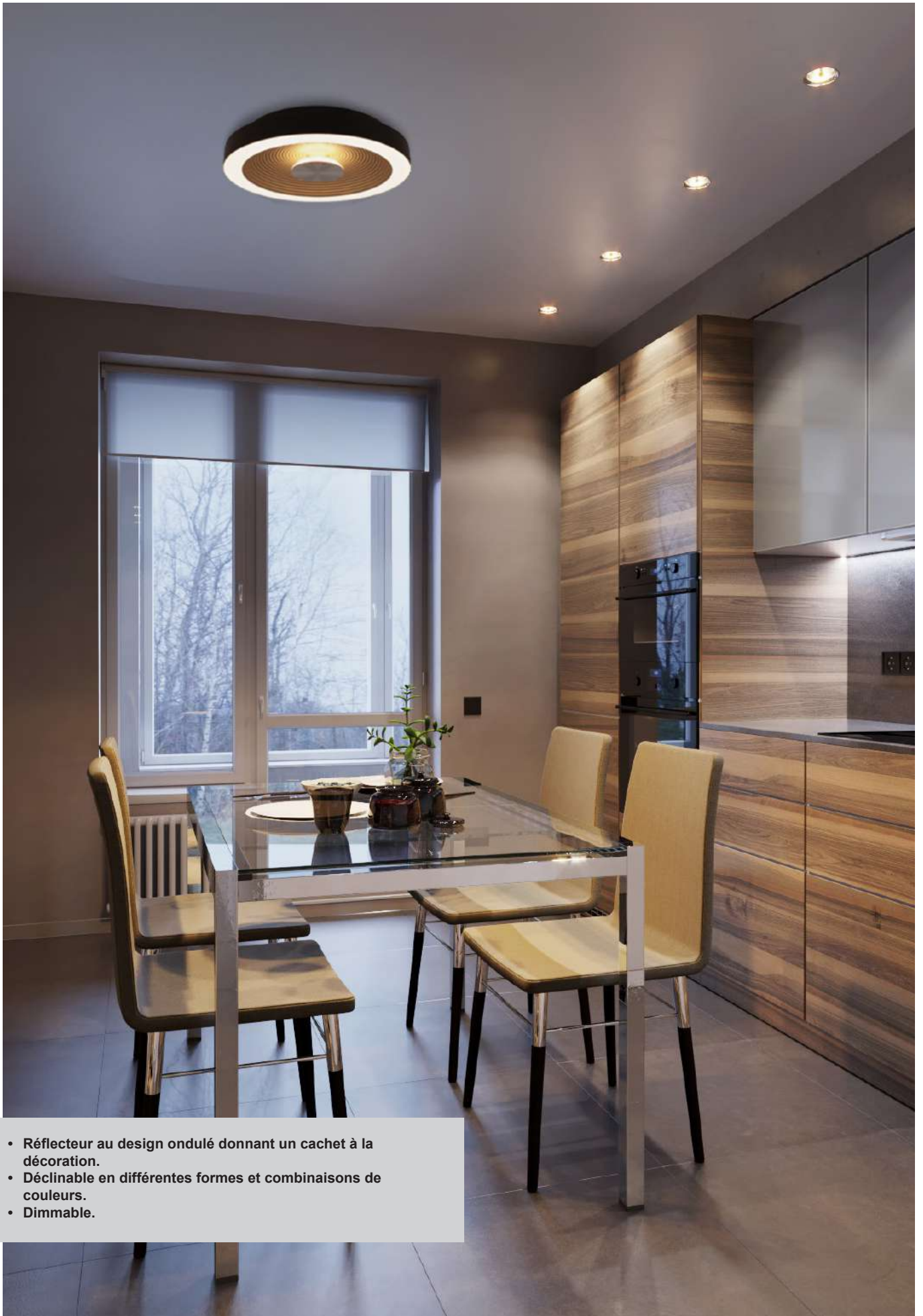

HULA P PAGE 241

HULA C

- Réflecteur au design ondulé donnant un cachet à la décoration.
- Déclinable en différentes formes et combinaisons de couleurs.
- Dimmable.

JUNE 1 C



- Applique murale ou plafonnier décoratif.
- Diffuseur en PS opalin.
- 2700K, 3000K ou 4000K au choix via un interrupteur dans le luminaire.
- Convertisseur dimmable intégré dans l'appareil.
- Compatible avec variateur début et fin de phase.

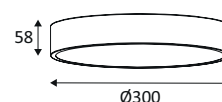

JUNE 1 C	COULEUR	MATIÈRE	P	CCT	LED LUMEN	SYSTEM LUMEN	α	€
WA22205	NOIR MAT	ALUMINIUM	18W	2700K 3000K 4000K	3300Lm (4000K)	1775Lm (4000K)	120°	120,00
WA22230	BLANC MAT	ALUMINIUM	18W	2700K 3000K 4000K	3300Lm (4000K)	1775Lm (4000K)	120°	120,00



NOIR MAT



BLANC MAT



DANS LA MÊME GAMME

JUNE 1 P PAGE 242

JUNE 2 C



- Applique murale ou plafonnier décoratif.
- Diffuseur en PS opalin.
- 2700K, 3000K ou 4000K au choix via un interrupteur dans le luminaire.
- Convertisseur dimmable intégré dans l'appareil.
- Compatible avec variateur début et fin de phase.

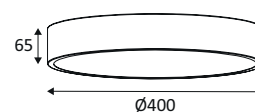

JUNE 2 C	COULEUR	MATIÈRE	P	CCT	LED LUMEN	SYSTEM LUMEN	α	€
WA22305	NOIR MAT	ALUMINIUM	30W	2700K 3000K 4000K	5600Lm (4000K)	3325Lm (4000K)	120°	195,00
WA22330	BLANC MAT	ALUMINIUM	30W	2700K 3000K 4000K	5600Lm (4000K)	3325Lm (4000K)	120°	195,00



NOIR MAT



BLANC MAT



DANS LA MÊME GAMME

JUNE 2 P PAGE 242



JUNE 3 C

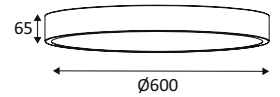

- Plafonnier décoratif.
- Diffuseur en PS opalin.
- 2700K, 3000K ou 4000K au choix via un interrupteur dans le luminaire.
- Convertisseur dimmable intégré dans l'appareil.
- Compatible avec variateur début et fin de phase.

JUNE 3 C	COULEUR	MATIÈRE	P	CCT	LED LUMEN	SYSTEM LUMEN	α	€
WA24105	■ NOIR MAT	ALUMINIUM	50W	2700K 3000K 4000K	8000Lm (4000K)	5920Lm (4000K)	120°	295,00
WA24130	■ BLANC MAT	ALUMINIUM	50W	2700K 3000K 4000K	8000Lm (4000K)	5920Lm (4000K)	120°	295,00



NOIR MAT



BLANC MAT



DANS LA MÊME GAMME

JUNE 3 P PAGE 243

JUNE 2 C



CAPRI R 1 C



- Applique murale ou plafonnier.
- Diffuseur PS à structure prismatique.
- 2700K, 3000K ou 4000K au choix via un interrupteur dans le luminaire.
- Convertisseur dimmable coupure de phase ou dimmable DALI-push intégré dans l'appareil.

CAPRI R 1 C	COULEUR	MATIÈRE	P	CCT	LED LUMEN	SYSTEM LUMEN	α	€
DIMMABLE COUPURE DE PHASE								
WA21605	■ NOIR MAT	ALUMINIUM	20W	2700K 3000K 4000K	2400Lm (4000K)	1360Lm (4000K)	90°	245,00
WA21630	■ BLANC MAT	ALUMINIUM	20W	2700K 3000K 4000K	2400Lm (4000K)	1360Lm (4000K)	90°	245,00
DIMMABLE DALI								
WA21605DA	■ NOIR MAT	ALUMINIUM	20W	2700K 3000K 4000K	2400Lm (4000K)	1360Lm (4000K)	90°	345,00
WA21630DA	■ BLANC MAT	ALUMINIUM	20W	2700K 3000K 4000K	2400Lm (4000K)	1360Lm (4000K)	90°	345,00



NOIR MAT



BLANC MAT

DANS LA MÊME GAMME



CAPRI R 1 P PAGE 244

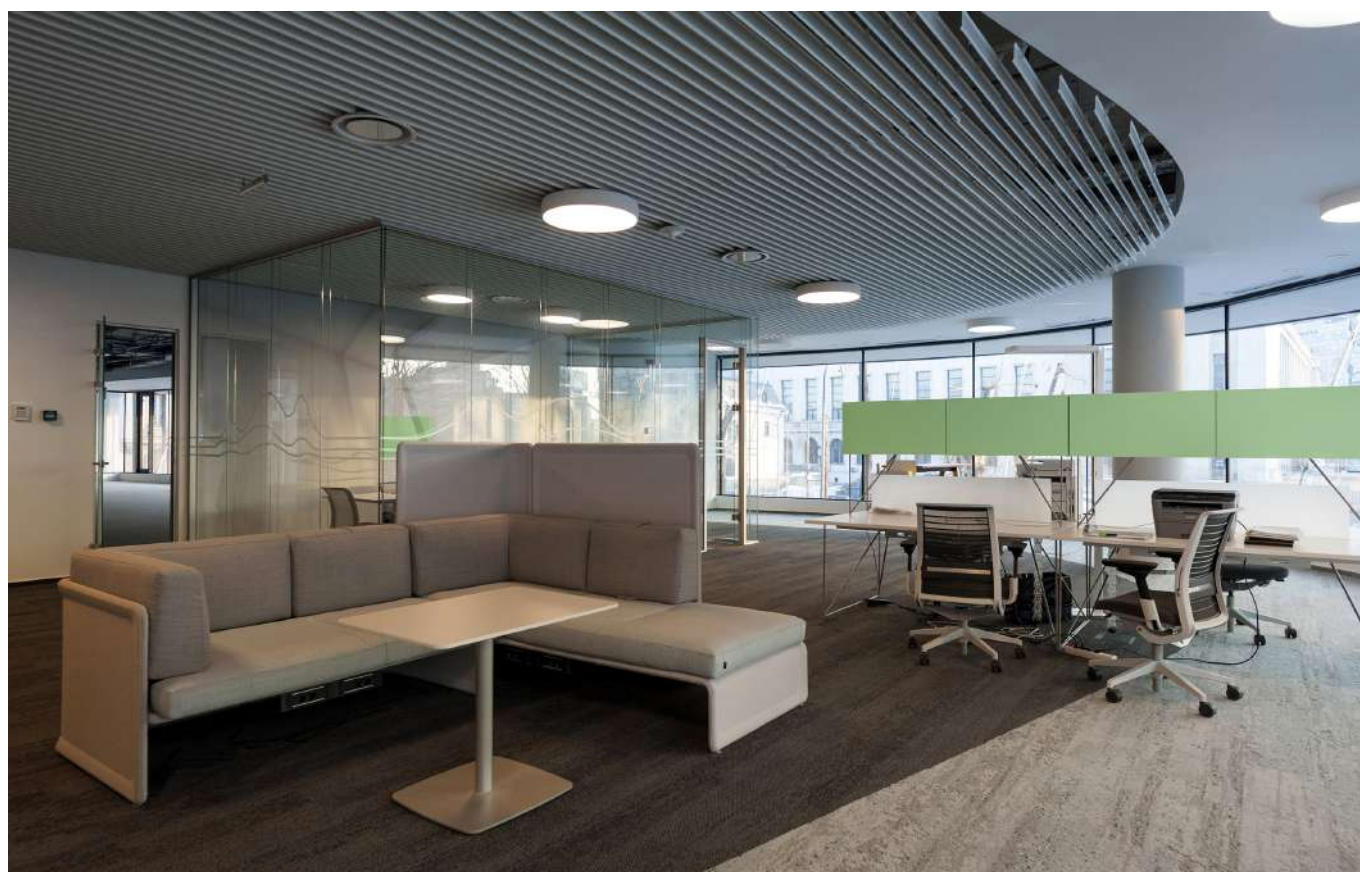



CAPRI R 2 C

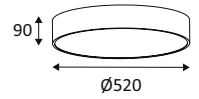

- Applique murale ou plafonnier.
- Diffuseur PS à structure prismatique.
- 2700K, 3000K ou 4000K au choix via un interrupteur dans le luminaire.
- Convertisseur dimmable coupure de phase ou dimmable DALI-push intégré dans l'appareil.

CAPRI R 2 C	COULEUR	MATIÈRE	P	CCT	LED LUMEN	SYSTEM LUMEN	α	€
DIMMABLE COUPURE DE PHASE								
WA21705	NOIR MAT	ALUMINIUM	42W	2700K 3000K 4000K	5150Lm (4000K)	2910Lm (4000K)	90°	385,00
WA21730	BLANC MAT	ALUMINIUM	42W	2700K 3000K 4000K	5150Lm (4000K)	2910Lm (4000K)	90°	385,00
DIMMABLE DALI								
WA21705DA	NOIR MAT	ALUMINIUM	42W	2700K 3000K 4000K	5150Lm (4000K)	2910Lm (4000K)	90°	485,00
WA21730DA	BLANC MAT	ALUMINIUM	42W	2700K 3000K 4000K	5150Lm (4000K)	2910Lm (4000K)	90°	521,00



NOIR MAT



BLANC MAT



DANS LA MÊME GAMME

CAPRI R 2 P PAGE 244

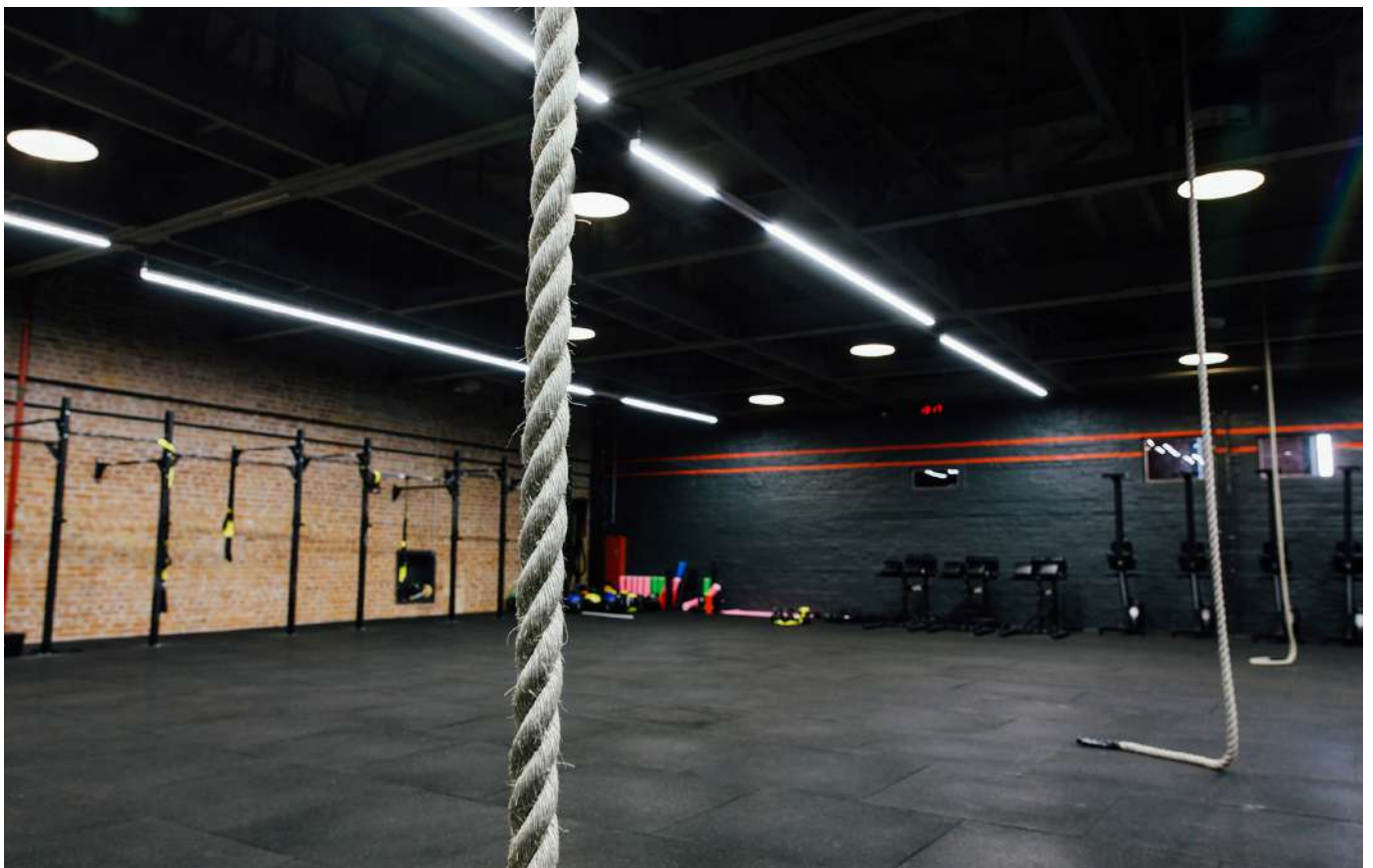

CAPRI R 3 C

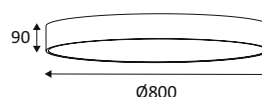

- Applique murale ou plafonnier.
- Diffuseur PS à structure prismatique.
- 2700K, 3000K ou 4000K au choix via un interrupteur dans le luminaire.
- Convertisseur dimmable DALI intégré dans l'appareil.

CAPRI R 3 C	COULEUR	MATIÈRE	P	CCT	LED LUMEN	SYSTEM LUMEN	α	€
DIMMABLE DALI								
WA21805DA	■ NOIR MAT	ALUMINIUM	105W	2700K 3000K 4000K	11800Lm (4000K)	7070Lm (4000K)	90°	1200,00
WA21830DA	■ BLANC MAT	ALUMINIUM	105W	2700K 3000K 4000K	11800Lm (4000K)	7070Lm (4000K)	90°	1200,00



NOIR MAT



BLANC MAT

DANS LA MÊME GAMME



CAPRI R 3 P PAGE 245





CAPRI S 1 C

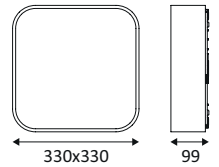

- Applique murale ou plafonnier.
- Diffuseur PS à structure prismatique.
- 2700K, 3000K ou 4000K au choix via un interrupteur dans le luminaire.
- Convertisseur dimmable coupure de phase ou dimmable DALI-push intégré dans l'appareil.

CAPRI S 1 C	COULEUR	MATIÈRE	P	CCT	L(MM)	LED LUMEN	SYSTEM LUMEN	α	€
DIMMABLE COUPURE DE PHASE									
WA24205	■ NOIR MAT	ALUMINIUM	20W	2700K 3000K 4000K	330	2400Lm (4000K)	1335Lm (4000K)	90°	270,00
WA24230	■ BLANC MAT	ALUMINIUM	20W	2700K 3000K 4000K	330	2400Lm (4000K)	1335Lm (4000K)	90°	270,00
DIMMABLE DALI									
WA24205DA	■ NOIR MAT	ALUMINIUM	20W	2700K 3000K 4000K	330	2400Lm (4000K)	1335Lm (4000K)	90°	390,00
WA24230DA	■ BLANC MAT	ALUMINIUM	20W	2700K 3000K 4000K	330	2400Lm (4000K)	1335Lm (4000K)	90°	390,00



NOIR MAT



BLANC MAT

DANS LA MÊME GAMME



CAPRI S 1 P PAGE 246

CAPRI S 2 C

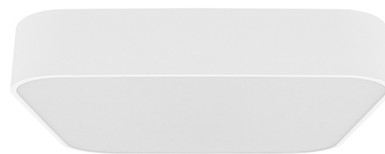
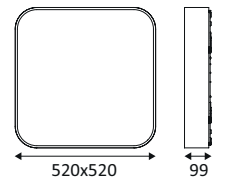

- Applique murale ou plafonnier.
- Diffuseur PS à structure prismatique.
- 2700K, 3000K ou 4000K au choix via un interrupteur dans le luminaire.
- Convertisseur dimmable coupure de phase ou dimmable DALI-push intégré dans l'appareil.

CAPRI S 2 C	COULEUR	MATIÈRE	P	CCT	L(MM)	LED LUMEN	SYSTEM LUMEN	α	€
DIMMABLE COUPURE DE PHASE									
WA24305	■ NOIR MAT	ALUMINIUM	42W	2700K 3000K 4000K	520	5150Lm (4000K)	3175Lm (4000K)	90°	420,00
WA24330	■ BLANC MAT	ALUMINIUM	42W	2700K 3000K 4000K	520	5150Lm (4000K)	3175Lm (4000K)	90°	420,00
DIMMABLE DALI									
WA24305DA	■ NOIR MAT	ALUMINIUM	42W	2700K 3000K 4000K	520	5150Lm (4000K)	3175Lm (4000K)	90°	565,00
WA24330DA	■ BLANC MAT	ALUMINIUM	42W	2700K 3000K 4000K	520	5150Lm (4000K)	3175Lm (4000K)	90°	565,00



NOIR MAT



BLANC MAT

DANS LA MÊME GAMME



CAPRI S 2 P PAGE 246

NOVA CSP 1 C



- Applique murale ou plafonnier rond.
- Diffuseur microprismatique.
- 2700K, 3000K ou 4000K au choix via un interrupteur dans le luminaire.
- Convertisseur dimmable DALI, Push-Dim et 1-10V intégré dans l'appareil.
- Kit d'éclairage indirect non-dimmable en option.

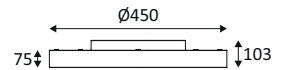

NOVA CSP 1 C	COULEUR	MATIÈRE	P	CCT	LED LUMEN	SYSTEM LUMEN	α	€
NVB45DS	NOIR MAT - DORÉ	ALUMINIUM	26W	2700K 3000K 4000K	3930Lm (4000K)	3000Lm (4000K)	120°	585,00
NVW45DS	BLANC MAT - DORÉ	ALUMINIUM	26W	2700K 3000K 4000K	3930Lm (4000K)	3000Lm (4000K)	120°	585,00

ACCESSOIRES	MATIÈRE	DESCRIPTION	€
NV45UPM	POLYCARBONATE	KIT UPLIGHT 13W 3000K 1100Lm	130,00



NOIR MAT - DORÉ



BLANC MAT - DORÉ



DANS LA MÊME GAMME

NOVA CSP 1 P PAGE 248

NOVA CSP 2 C



- Applique murale ou plafonnier rond.
- Diffuseur microprismatique.
- 2700K, 3000K ou 4000K au choix via un interrupteur dans le luminaire.
- Convertisseur dimmable DALI, Push-Dim et 1-10V intégré dans l'appareil.
- Kit d'éclairage indirect non-dimmable en option.

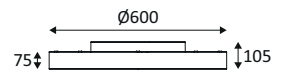

NOVA CSP 2 C	COULEUR	MATIÈRE	P	CCT	LED LUMEN	SYSTEM LUMEN	α	€
NVB60DS	NOIR MAT - DORÉ	ALUMINIUM	40W	2700K 3000K 4000K	6075Lm (4000K)	4800Lm (4000K)	120°	795,00
NVW60DS	BLANC MAT - DORÉ	ALUMINIUM	40W	2700K 3000K 4000K	6075Lm (4000K)	4800Lm (4000K)	120°	795,00

ACCESSOIRES	MATIÈRE	DESCRIPTION	€
NV60UPM	POLYCARBONATE	KIT UPLIGHT 20W 3000K 1700Lm	188,00



NOIR MAT - DORÉ BLANC MAT - DORÉ



DANS LA MÊME GAMME

NOVA CSP 2 P PAGE 248



NOVA CSP 3 C

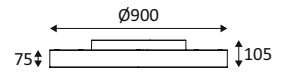

- Plafonnier rond.
- Diffuseur microprismatique.
- 2700K, 3000K ou 4000K au choix via un interrupteur dans le luminaire.
- Convertisseur dimmable DALI, Push-Dim et 1-10V intégré dans l'appareil.
- Kit d'éclairage indirect non-dimmable en option.

NOVA CSP 3 C	COULEUR	MATIÈRE	P	CCT	LED LUMEN	SYSTEM LUMEN	α	€
NVB90DS	NOIR MAT - DORÉ	ALUMINIUM	68W	2700K 3000K 4000K	10740Lm (4000K)	9000Lm (4000K)	120°	1580,00
NVW90DS	BLANC MAT - DORÉ	ALUMINIUM	68W	2700K 3000K 4000K	10740Lm (4000K)	9000Lm (4000K)	120°	1580,00

ACCESSOIRES	MATIÈRE	DESCRIPTION	€
NV90UPM	POLYCARBONATE	KIT UPLIGHT 28W 3000K 2400Lm	285,00



NOIR MAT - DORÉ



BLANC MAT - DORÉ

DANS LA MÊME GAMME



NOVA CSP 3 P PAGE 249



- Luminaire apparent au design moderne et élégant.
- Excellent confort visuel grâce à un UGR inférieur à 19. Convient à l'éclairage de bureaux et salles de classe.
- Sélection de la température de couleur (2700K, 3000K ou 4000K).
- Rendement élevé (efficacité lumineuse supérieure à 115lm/W).
- Diffuseur à structure prismatique de haute qualité.
- Trois modes de variation : DALI, Push-dim ou 1-10V.
- Garantie de 5 ans.
- Kit d'éclairage indirect disponible séparément.

DOTS C

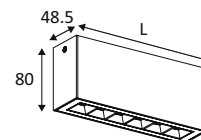

- Plafonnier rectangulaire fixe pour éclairage d'accentuation.
- Réflecteur basse luminance.
- Convertisseur dimmable intégré dans l'appareil.
- Compatible avec variateur début et fin de phase.

DOTS C	COULEUR	MATIÈRE	P	CCT	L(MM)	LED LUMEN	SYSTEM LUMEN	α	€
WA248WW05	NOIR MAT	ALUMINIUM	6W	3000K	108	470Lm	300Lm	45°	81,00
WA248WW30	BLANC MAT	ALUMINIUM	6W	3000K	108	470Lm	300Lm	45°	81,00
WA249WW05	NOIR MAT	ALUMINIUM	12W	3000K	188	940Lm	565Lm	45°	115,00
WA249WW30	BLANC MAT	ALUMINIUM	12W	3000K	188	940Lm	565Lm	45°	115,00
WA250WW05	NOIR MAT	ALUMINIUM	16W	3000K	268	1400Lm	895Lm	45°	134,00
WA250WW30	BLANC MAT	ALUMINIUM	16W	3000K	268	1400Lm	895Lm	45°	134,00
WA251WW05	NOIR MAT	ALUMINIUM	20W	3000K	348	1880Lm	1165Lm	45°	156,00
WA251WW30	BLANC MAT	ALUMINIUM	20W	3000K	348	1880Lm	1165Lm	45°	156,00



NOIR MAT



BLANC MAT



NOIR MAT



BLANC MAT



NOIR MAT



BLANC MAT

DANS LA MÊME GAMME



DOTS PAGE 85

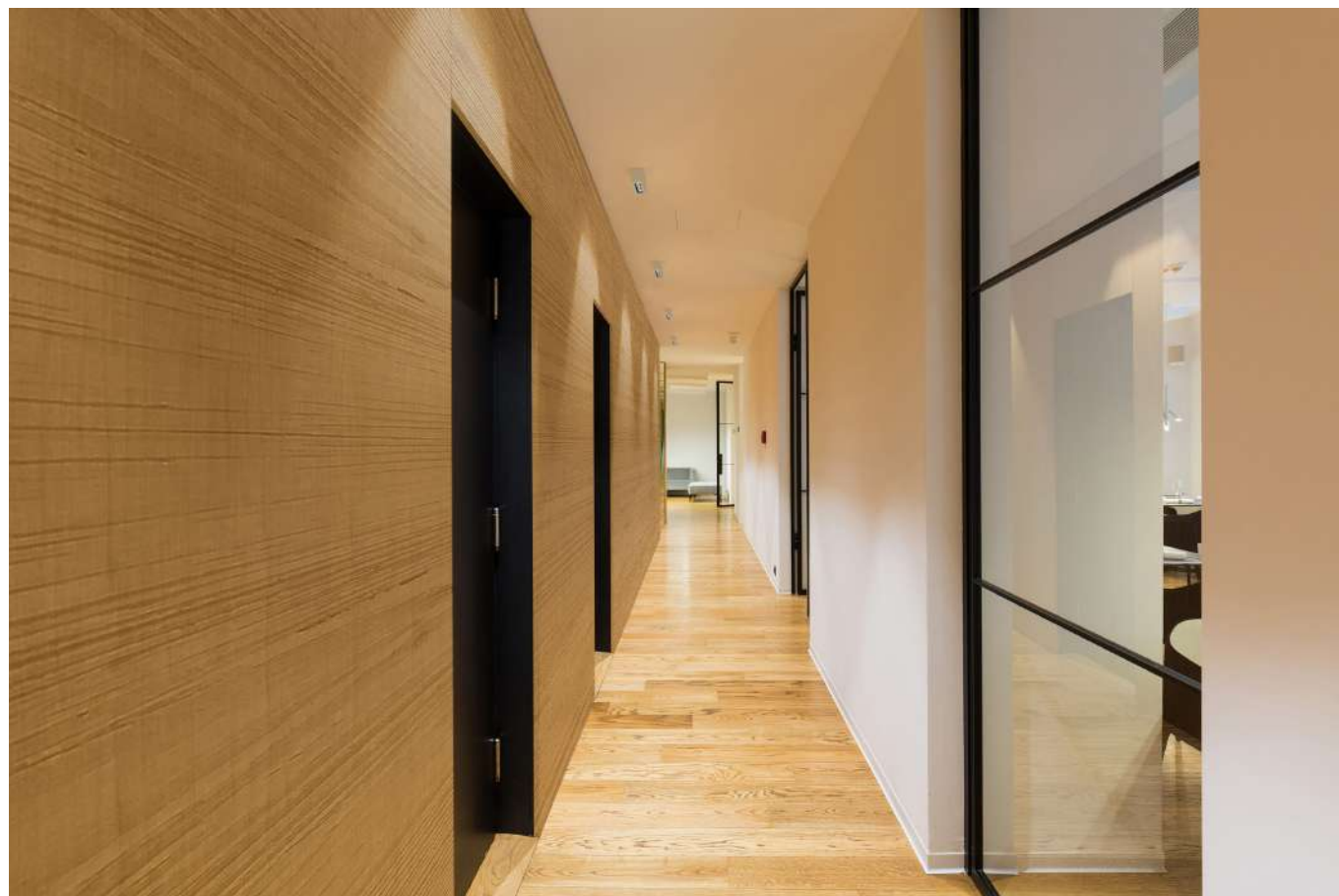



TOMY 1 C

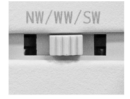
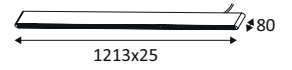

- Plafonnier linéaire.
- Réflecteur basse luminance.
- 2700K, 3000K ou 4000K au choix via un interrupteur à l'arrière du luminaire.
- Livré avec câble d'alimentation noir ou blanc.
- Convertisseur non dimmable intégré dans l'appareil.

TOMY 1 C	COULEUR	MATIÈRE	P	CCT	L (MM)	LED LUMEN	SYSTEM LUMEN	α	€
WA22405	■ NOIR MAT	ALUMINIUM	36W	2700K 3000K 4000K	1213	4100Lm (4000K)	2835Lm (4000K)	36°	205,00
WA22430	■ BLANC MAT	ALUMINIUM	36W	2700K 3000K 4000K	1213	4100Lm (4000K)	2835Lm (4000K)	36°	205,00



NOIR MAT



BLANC MAT

DANS LA MÊME GAMME



TOMY 1 P PAGE 254



TOMY 2 P PAGE 254

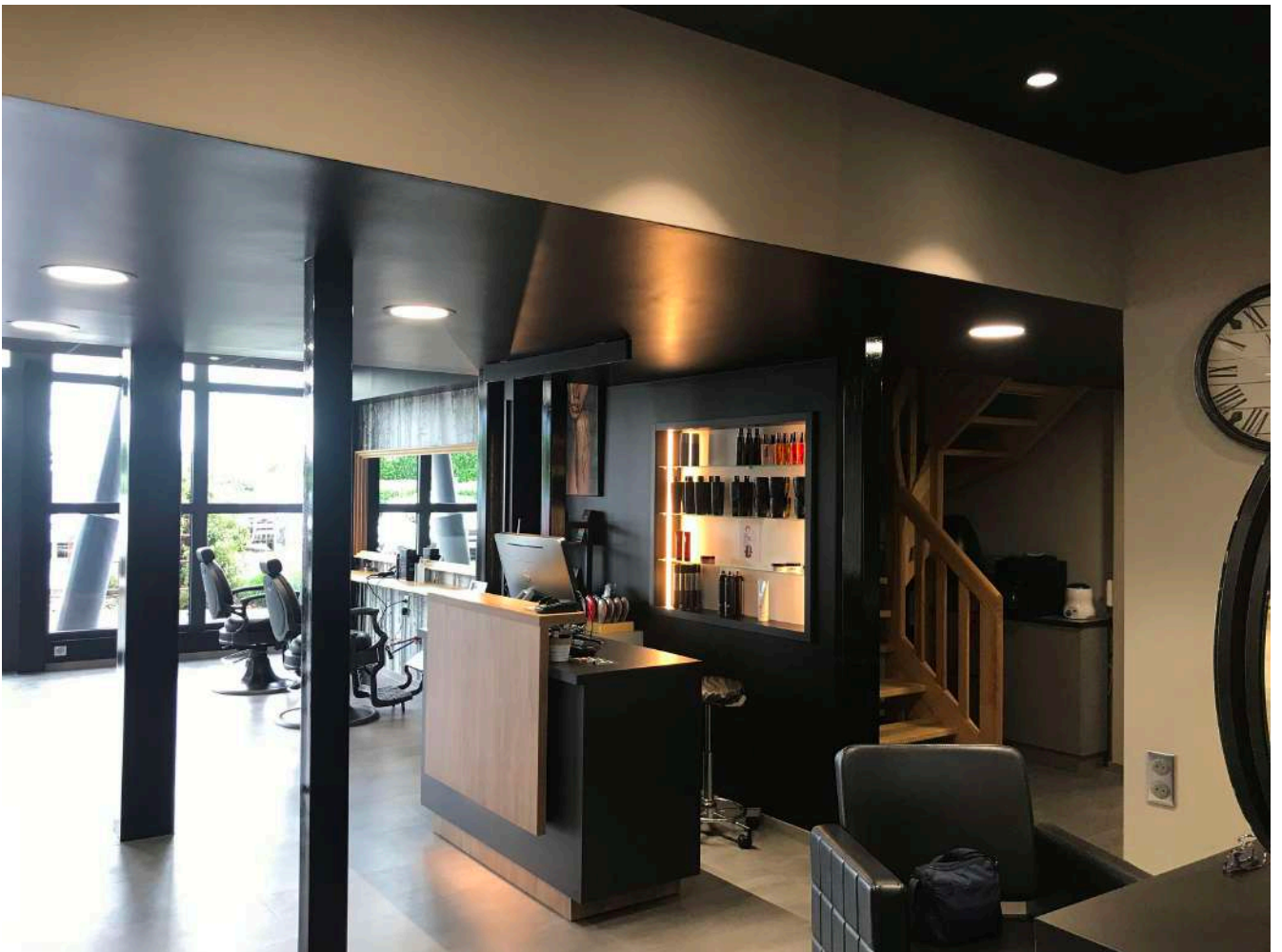

SUSPENSIONS

AUREA P





AUREA P



- Suspension décorative.
- Livrée avec câble d'alimentation (réglable 2.00m max).
- Coloris 05 - 08 - 83 : câble noir.
- Coloris 30 - 49 - 82 : câble blanc.
- 2700K, 3000K ou 4000K au choix via un interrupteur à l'arrière du luminaire.
- Convertisseur dimmable intégré dans l'appareil.
- Compatible avec variateur début de phase.



AUREA P	COULEUR	MATIÈRE	P	CCT	LED LUMEN	SYSTEM LUMEN	α	€
SU16905	NOIR MAT	ALUMINIUM	6W	2700K 3000K 4000K	715Lm (4000K)	550Lm (4000K)	38°	152,00
SU16908	NOIR MAT - CHAMPAGNE	ALUMINIUM	6W	2700K 3000K 4000K	715Lm (4000K)	550Lm (4000K)	38°	155,00
SU16983	NOIR MAT - ROSE	ALUMINIUM	6W	2700K 3000K 4000K	715Lm (4000K)	550Lm (4000K)	38°	155,00
SU16930	BLANC MAT	ALUMINIUM	6W	2700K 3000K 4000K	715Lm (4000K)	550Lm (4000K)	38°	152,00
SU16949	BLANC MAT - CHAMPAGNE	ALUMINIUM	6W	2700K 3000K 4000K	715Lm (4000K)	550Lm (4000K)	38°	155,00
SU16982	BLANC MAT - ROSE	ALUMINIUM	6W	2700K 3000K 4000K	715Lm (4000K)	550Lm (4000K)	38°	155,00

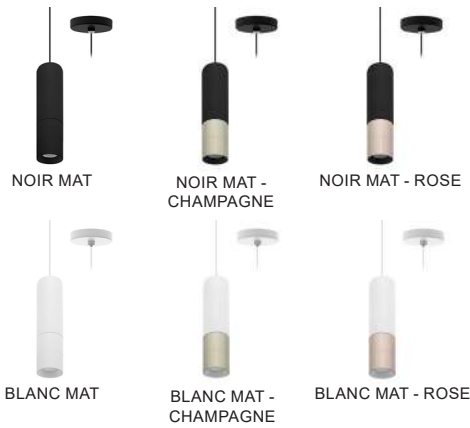

DANS LA MÊME GAMME



AUREA 1 C PAGE 202



AUREA 4 W PAGE 159



AUREA 3 W PAGE 158



AUREA 2 C PAGE 203

OLYN 1 P



- Suspension décorative.
- Montage en saillie.
- Livrée avec câble d'alimentation noir (réglable 2,00m max).
- 3000K, 3500K ou 4000K au choix via un interrupteur dans la base de montage.
- Convertisseur dimmable par coupure de phase intégré dans la base de montage.
- Très basse luminance grâce à un design d'optique à réflexion totale interne.



OLYN 1 P	COULEUR	MATIÈRE	P	CCT	LED LUMEN	SYSTEM LUMEN	α	€
SU18405 NEW	NOIR MAT	ALUMINIUM	15W	3000K 3500K 4000K	1820Lm (4000K)	1340Lm (4000K)	36°	130,00
SU18430 NEW	BLANC MAT	ALUMINIUM	15W	3000K 3500K 4000K	1820Lm (4000K)	1340Lm (4000K)	36°	130,00
SU18431 NEW	NOIR MAT - BRONZE SATINÉ	ALUMINIUM	15W	3000K 3500K 4000K	1820Lm (4000K)	1340Lm (4000K)	36°	150,00
SU18451 NEW	BLANC MAT - ROSE BROSSÉ	ALUMINIUM	15W	3000K 3500K 4000K	1820Lm (4000K)	1340Lm (4000K)	36°	150,00
SU18456 NEW	BLANC MAT - NICKEL BROSSÉ	ALUMINIUM	15W	3000K 3500K 4000K	1820Lm (4000K)	1340Lm (4000K)	36°	150,00
SU18457 NEW	NOIR MAT - NICKEL BROSSÉ	ALUMINIUM	15W	3000K 3500K 4000K	1820Lm (4000K)	1340Lm (4000K)	36°	150,00
SU18459 NEW	BLANC MAT - OR BROSSÉ	ALUMINIUM	15W	3000K 3500K 4000K	1820Lm (4000K)	1340Lm (4000K)	36°	150,00
SU18465 NEW	BLANC MAT - BRONZE SATINÉ	ALUMINIUM	15W	3000K 3500K 4000K	1820Lm (4000K)	1340Lm (4000K)	36°	150,00
SU18467 NEW	NOIR MAT - ROSE BROSSÉ	ALUMINIUM	15W	3000K 3500K 4000K	1820Lm (4000K)	1340Lm (4000K)	36°	150,00
SU18468 NEW	NOIR MAT - OR BROSSÉ	ALUMINIUM	15W	3000K 3500K 4000K	1820Lm (4000K)	1340Lm (4000K)	36°	150,00



DANS LA MÊME GAMME

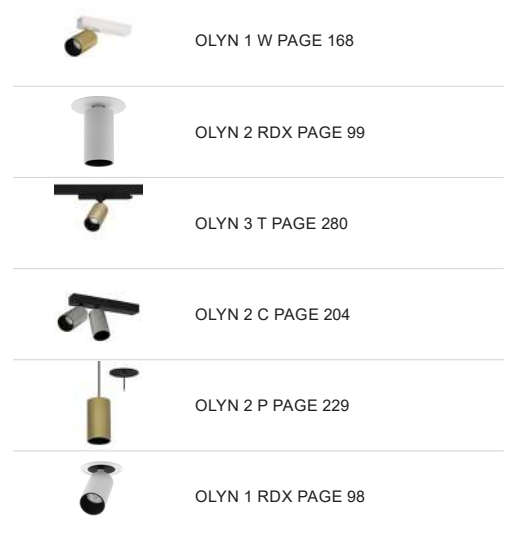



NEW

OLYN 2 P



- Suspension décorative.
- Patère encastrée avec fixation par ressorts.
- Livrée avec câble d'alimentation noir (réglable 2,00m max).
- 3000K, 3500K ou 4000K au choix via un interrupteur à l'arrière du luminaire.
- Convertisseur dimmable par coupure de phase déporté fourni.
- Très basse luminance grâce à un design d'optique à réflexion totale interne.

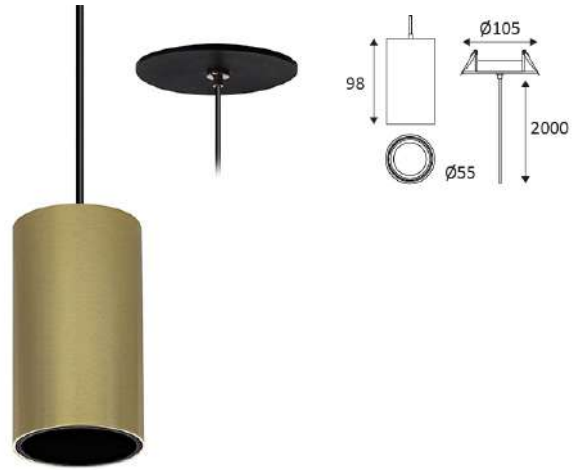

OLYN 2 P	COULEUR	MATIÈRE	P	CCT	LED LUMEN	SYSTEM LUMEN	α	€
SU18505 NEW	NOIR MAT	ALUMINIUM	15W	3000K 3500K 4000K	1820Lm (4000K)	1340Lm (4000K)	36°	140,00
SU18530 NEW	BLANC MAT	ALUMINIUM	15W	3000K 3500K 4000K	1820Lm (4000K)	1340Lm (4000K)	36°	140,00
SU18531 NEW	NOIR MAT - BRONZE SATINÉ	ALUMINIUM	15W	3000K 3500K 4000K	1820Lm (4000K)	1340Lm (4000K)	36°	160,00
SU18551 NEW	BLANC MAT - ROSE BROSSÉ	ALUMINIUM	15W	3000K 3500K 4000K	1820Lm (4000K)	1340Lm (4000K)	36°	160,00
SU18556 NEW	BLANC MAT - NICKEL BROSSÉ	ALUMINIUM	15W	3000K 3500K 4000K	1820Lm (4000K)	1340Lm (4000K)	36°	160,00
SU18557 NEW	NOIR MAT - NICKEL BROSSÉ	ALUMINIUM	15W	3000K 3500K 4000K	1820Lm (4000K)	1340Lm (4000K)	36°	160,00
SU18559 NEW	BLANC MAT - OR BROSSÉ	ALUMINIUM	15W	3000K 3500K 4000K	1820Lm (4000K)	1340Lm (4000K)	36°	160,00
SU18565 NEW	BLANC MAT - BRONZE SATINÉ	ALUMINIUM	15W	3000K 3500K 4000K	1820Lm (4000K)	1340Lm (4000K)	36°	160,00
SU18567 NEW	NOIR MAT - ROSE BROSSÉ	ALUMINIUM	15W	3000K 3500K 4000K	1820Lm (4000K)	1340Lm (4000K)	36°	160,00
SU18568 NEW	NOIR MAT - OR ROSE	ALUMINIUM	15W	3000K 3500K 4000K	1820Lm (4000K)	1340Lm (4000K)	36°	160,00



DANS LA MÊME GAMME



OLYN 1 W PAGE 168



OLYN 2 RDX PAGE 99



OLYN 3 T PAGE 280



OLYN 2 C PAGE 204



OLYN 1 RDX PAGE 98



OLYN 1 P PAGE 228

JACK 3 P



- Suspension décorative.
- Livrée avec câble d'alimentation textile (réglable 1.60m max).
- Coloris 05 - 13 - 06 : câble noir.
- Coloris 30 - 28 - 02 : câble blanc.
- 2700K, 3000K ou 4000K au choix via un interrupteur à l'arrière du luminaire.
- Convertisseur dimmable intégré dans l'appareil.
- Compatible avec variateur fin de phase.

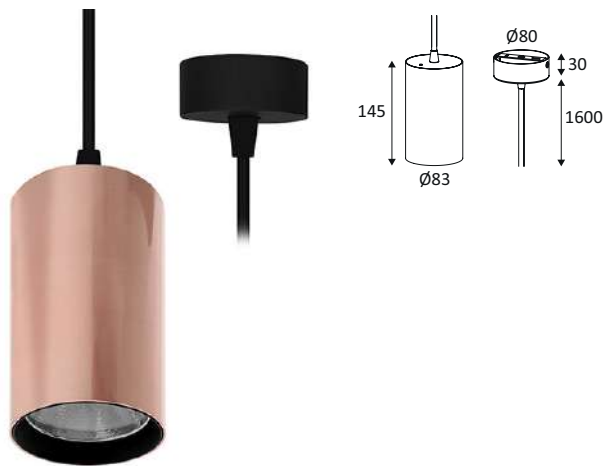

JACK 3 P	COULEUR	MATIÈRE	P	CCT	LED LUMEN	SYSTEM LUMEN	α	€
SU16105	■ NOIR MAT	ALUMINIUM	25W	2700K 3000K 4000K	2810Lm (4000K)	2270Lm (4000K)	60°	230,00
SU16113	■ NOIR MAT - DORÉ	ALUMINIUM	25W	2700K 3000K 4000K	2810Lm (4000K)	2270Lm (4000K)	60°	255,00
SU16106	■ NOIR MAT - OR ROSE	ALUMINIUM	25W	2700K 3000K 4000K	2810Lm (4000K)	2270Lm (4000K)	60°	255,00
SU16130	■ BLANC MAT	ALUMINIUM	25W	2700K 3000K 4000K	2810Lm (4000K)	2270Lm (4000K)	60°	230,00
SU16128	■ BLANC MAT - LAITON	ALUMINIUM	25W	2700K 3000K 4000K	2810Lm (4000K)	2270Lm (4000K)	60°	255,00
SU16102	■ BLANC MAT - OR ROSE	ALUMINIUM	25W	2700K 3000K 4000K	2810Lm (4000K)	2270Lm (4000K)	60°	255,00





JACK 3 P



RONDY 1 P



- Suspension décorative.
- Diffuseur en verre opalin.
- Livrée avec câble d'alimentation textile (réglable 1.50m max).
- Coloris 05 - 58 - 61 : câble noir.
- Coloris 30 : câble blanc.
- Convertisseur dimmable par coupure de phase intégré dans la base.

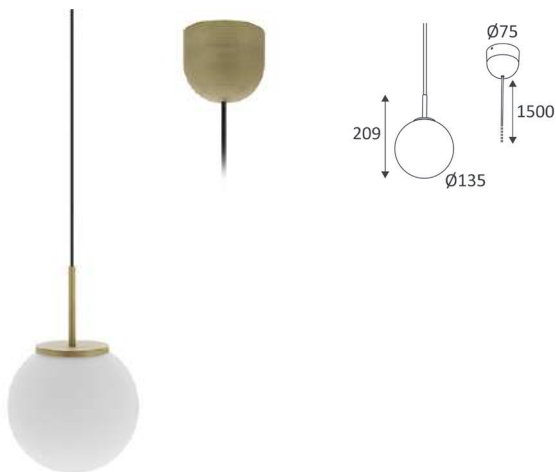

RONDY 1 P	COULEUR	MATIÈRE	P	CCT	LED LUMEN	SYSTEM LUMEN	€
SU175WW05 NEW	NOIR MAT	ALUMINIUM	11,8W	2700K	1440Lm	1190Lm	170,00
SU175WW30 NEW	BLANC MAT	ALUMINIUM	11,8W	2700K	1440Lm	1190Lm	170,00
SU175WW58 NEW	GRIS CANON DE FUSIL	ALUMINIUM	11,8W	2700K	1440Lm	1190Lm	200,00
SU175WW61 NEW	LAITON BROSSÉ	ALUMINIUM	11,8W	2700K	1440Lm	1190Lm	200,00

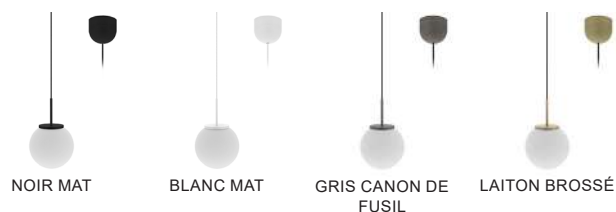

RONDY 2 P



- Suspension décorative.
- Diffuseur en verre opalin.
- Livrée avec câble d'alimentation textile (réglable 1.50m max).
- Coloris 05 - 58 - 61 : câble noir.
- Coloris 30 : câble blanc.
- Convertisseur dimmable par coupure de phase intégré dans la base.

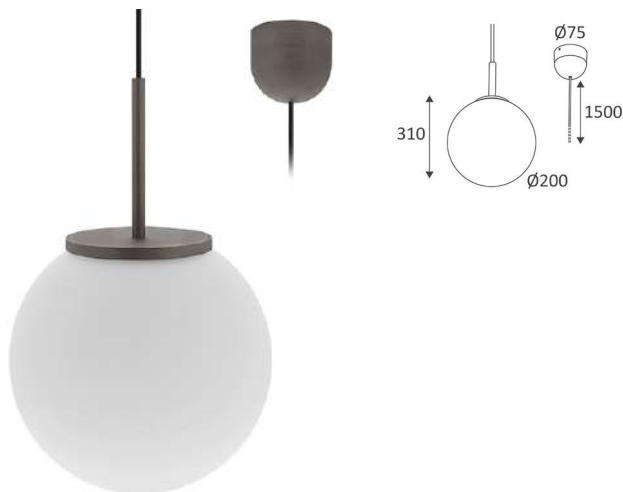

RONDY 2 P	COULEUR	MATIÈRE	P	CCT	LED LUMEN	SYSTEM LUMEN	€
SU176WW05 NEW	NOIR MAT	ALUMINIUM	17,5W	3000K	2100Lm	1740Lm	240,00
SU176WW30 NEW	BLANC MAT	ALUMINIUM	17,5W	3000K	2100Lm	1740Lm	240,00
SU176WW58 NEW	GRIS CANON DE FUSIL	ALUMINIUM	17,5W	3000K	2100Lm	1740Lm	270,00
SU176WW61 NEW	LAITON BROSSÉ	ALUMINIUM	17,5W	3000K	2100Lm	1740Lm	270,00

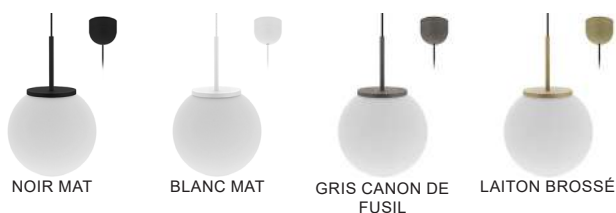

RONDY 1 P

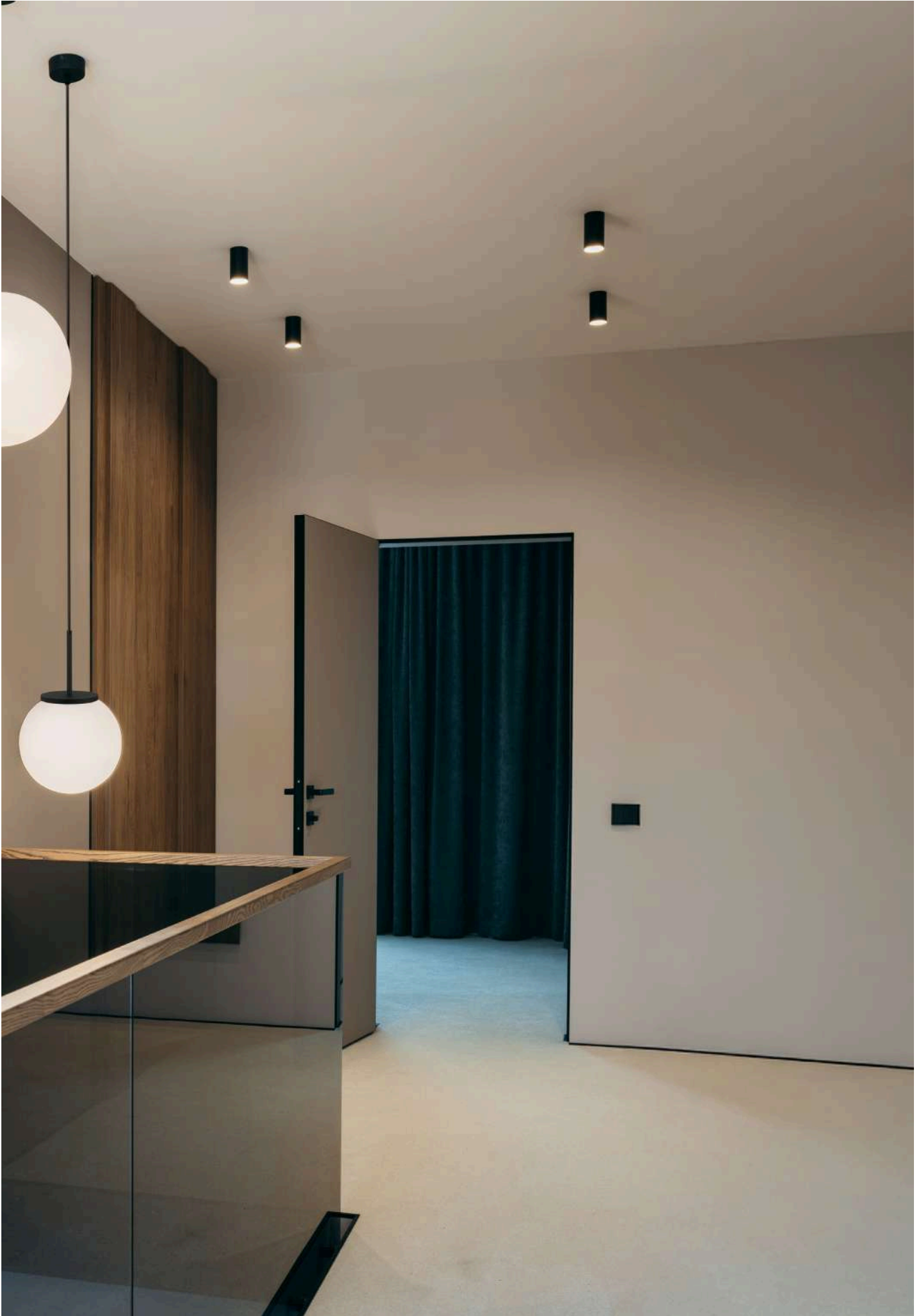

OBIA 1 P



- Suspension décorative.
- Montage en saillie.
- Tête inclinable jusqu'à 45°.
- Livrée avec câble de suspension textile (réglable 1,50m max).
- Coloris 05 : câble noir.
- Coloris 30 : câble blanc.
- CCT (2700K, 3000K ou 4000K) et puissance (6 ou 9W) au choix via un interrupteur dans le luminaire.
- Convertisseur dimmable par coupure de phase intégré dans le luminaire.



OBIA 1 P	COULEUR	MATIÈRE	P	CCT	LED LUMEN	SYSTEM LUMEN	α	€
SU18605 NEW	NOIR MAT	FONTE D'ALUMINIUM	6-9W	2700K 3000K 4000K	950Lm (4000K)	710Lm (4000K)	150°	180,00
SU18630 NEW	BLANC MAT	FONTE D'ALUMINIUM	6-9W	2700K 3000K 4000K	950Lm (4000K)	710Lm (4000K)	150°	180,00



OBIA 2 P



- Suspension décorative.
- Montage en saillie.
- Tête inclinable jusqu'à 45°.
- Livrée avec câble de suspension textile (réglable 1,50m max).
- Coloris 05-08-35 : câble noir.
- Coloris 30-49-81 : câble blanc.
- CCT (2700K, 3000K ou 4000K) et puissance (6 ou 9W) au choix via un interrupteur dans le luminaire.
- Convertisseur dimmable par coupure de phase intégré dans le luminaire.



OBIA 2 P	COULEUR	MATIÈRE	P	CCT	LED LUMEN	SYSTEM LUMEN	α	€
SU18705 NEW	NOIR MAT	FONTE D'ALUMINIUM	6-9W	2700K 3000K 4000K	950Lm (4000K)	755Lm (4000K)	60°	190,00
SU18708 NEW	NOIR MAT - CHAMPAGNE	FONTE D'ALUMINIUM	6-9W	2700K 3000K 4000K	950Lm (4000K)	755Lm (4000K)	60°	200,00
SU18730 NEW	BLANC MAT	FONTE D'ALUMINIUM	6-9W	2700K 3000K 4000K	950Lm (4000K)	755Lm (4000K)	60°	190,00
SU18735 NEW	NOIR MAT - BLANC MAT	FONTE D'ALUMINIUM	6-9W	2700K 3000K 4000K	950Lm (4000K)	755Lm (4000K)	60°	200,00
SU18749 NEW	BLANC MAT - CHAMPAGNE	FONTE D'ALUMINIUM	6-9W	2700K 3000K 4000K	950Lm (4000K)	755Lm (4000K)	60°	200,00
SU18781 NEW	BLANC MAT - NOIR	FONTE D'ALUMINIUM	6-9W	2700K 3000K 4000K	950Lm (4000K)	755Lm (4000K)	60°	200,00





OBIA 2 P



RETI P



- Suspension décorative.
- Faisceau lumineux précisément dessiné grâce à une lentille en verre de haute qualité.
- Livrée avec câble d'alimentation noir facilement réglable (de 1.00 à 2.30m) grâce à un système de poulie.
- Convertisseur non dimmable intégré dans la base.



RETI P	COULEUR	MATIÈRE	P	CCT	LED LUMEN	SYSTEM LUMEN	α	€
SU173WW05	■ NOIR MAT	ALUMINIUM	12W	3000K	1080Lm	1035Lm	80°	310,00
SU173WW31	■ NOIR MAT - CHAMPAGNE	ALUMINIUM	12W	3000K	1080Lm	1035Lm	80°	310,00
SU173WW30	■ BLANC MAT	ALUMINIUM	12W	3000K	1080Lm	1035Lm	80°	310,00



DANS LA MÊME GAMME



RETI 2 RX PAGE 104



RETI 1 RX PAGE 104



RETI W PAGE 170

**RETI P**

- Déclinable en applique, suspension ou semi-encastré.
- Faisceau lumineux précisément dessiné donnant un effet graphique.
- Finition de qualité supérieure.

DROPY P



- Suspension décorative.
- Patère encastrée avec fixation par ressorts.
- Livrée avec câble d'alimentation textile (réglable 1.50m max).
- Coloris 05 - 07 - 58 - 61 : câble noir.
- Coloris 30 : câble blanc.
- Convertisseur dimmable par coupure de phase déporté fourni.

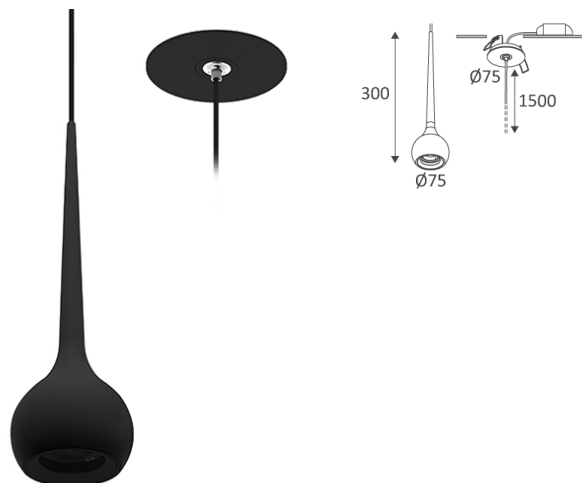

DROPY P	COULEUR	MATIÈRE	P	CCT	LED LUMEN	SYSTEM LUMEN	α	€
SU177WW05	■ NOIR MAT	ALUMINIUM	12,5W	3000K	1075Lm	980Lm	50°	210,00
SU177WW30	■ BLANC MAT	ALUMINIUM	12,5W	3000K	1075Lm	980Lm	50°	210,00
SU177WW07	■ OR ROSE	ALUMINIUM	12,5W	3000K	1075Lm	980Lm	50°	265,00
SU177WW58	■ GRIS CANON DE FUSIL	ALUMINIUM	12,5W	3000K	1075Lm	980Lm	50°	265,00
SU177WW61	■ LAITON BROSSÉ	ALUMINIUM	12,5W	3000K	1075Lm	980Lm	50°	265,00



DROPY P





HELLO 1 P

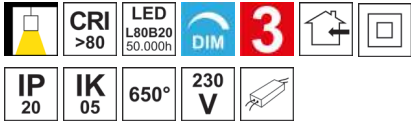

- Suspension décorative.
- Diffuseur en PMMA.
- Livrée avec câble d'alimentation textile noir ou blanc (réglable 2.00m max).
- Convertisseur dimmable intégré dans la base.
- Compatible avec variateur début et fin de phase.

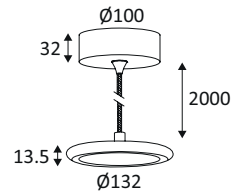

HELLO 1 P	COULEUR	MATIÈRE	P	CCT	LED LUMEN	SYSTEM LUMEN	α	€
SU166WW05	NOIR MAT	ALUMINIUM	11W	3000K	1300Lm	1070Lm	110°	140,00
SU166WW30	BLANC MAT	ALUMINIUM	11W	3000K	1300Lm	1070Lm	110°	140,00

DANS LA MÊME GAMME



HELLO 1 D PAGE 282



NOIR MAT

BLANC MAT

HELLO 2 P

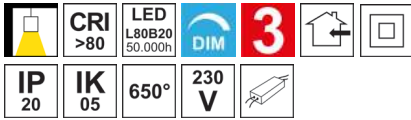

- Suspension décorative.
- Diffuseur en PMMA.
- Livrée avec câble d'alimentation textile noir ou blanc (réglable 2.00m max).
- Convertisseur dimmable intégré dans la base.
- Compatible avec variateur début et fin de phase.

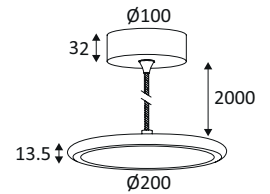

HELLO 2 P	COULEUR	MATIÈRE	P	CCT	LED LUMEN	SYSTEM LUMEN	α	€
SU167WW05	NOIR MAT	ALUMINIUM	18W	3000K	2160Lm	1835Lm	110°	185,00
SU167WW30	BLANC MAT	ALUMINIUM	18W	3000K	2160Lm	1835Lm	110°	185,00

DANS LA MÊME GAMME



HELLO 2 D PAGE 282



NOIR MAT

BLANC MAT

HUBA P



- Suspension décorative.
- Eclairage indirect via le réflecteur au design ondulé créant une ambiance agréable.
- Livrée avec câble d'alimentation textile noir ou blanc (réglable 1.40m max).
- Convertisseur dimmable intégré dans l'appareil.
- Compatible avec variateur début et fin de phase.



HUBA P	COULEUR	MATIÈRE	P	CCT	LED LUMEN	SYSTEM LUMEN	α	€
AIN3KPLBKWH	NOIR MAT - BLANC MAT	ACIER	15W	3000K	1600Lm	1140Lm	120°	119,00
AIN3KPLBKGD	NOIR MAT - DORÉ	ACIER	15W	3000K	1600Lm	745Lm	120°	119,00
AIN3KPLWHWH	BLANC MAT	ACIER	15W	3000K	1600Lm	1140Lm	120°	119,00
AIN3KPLWHGD	BLANC MAT - DORÉ	ACIER	15W	3000K	1600Lm	745Lm	120°	119,00

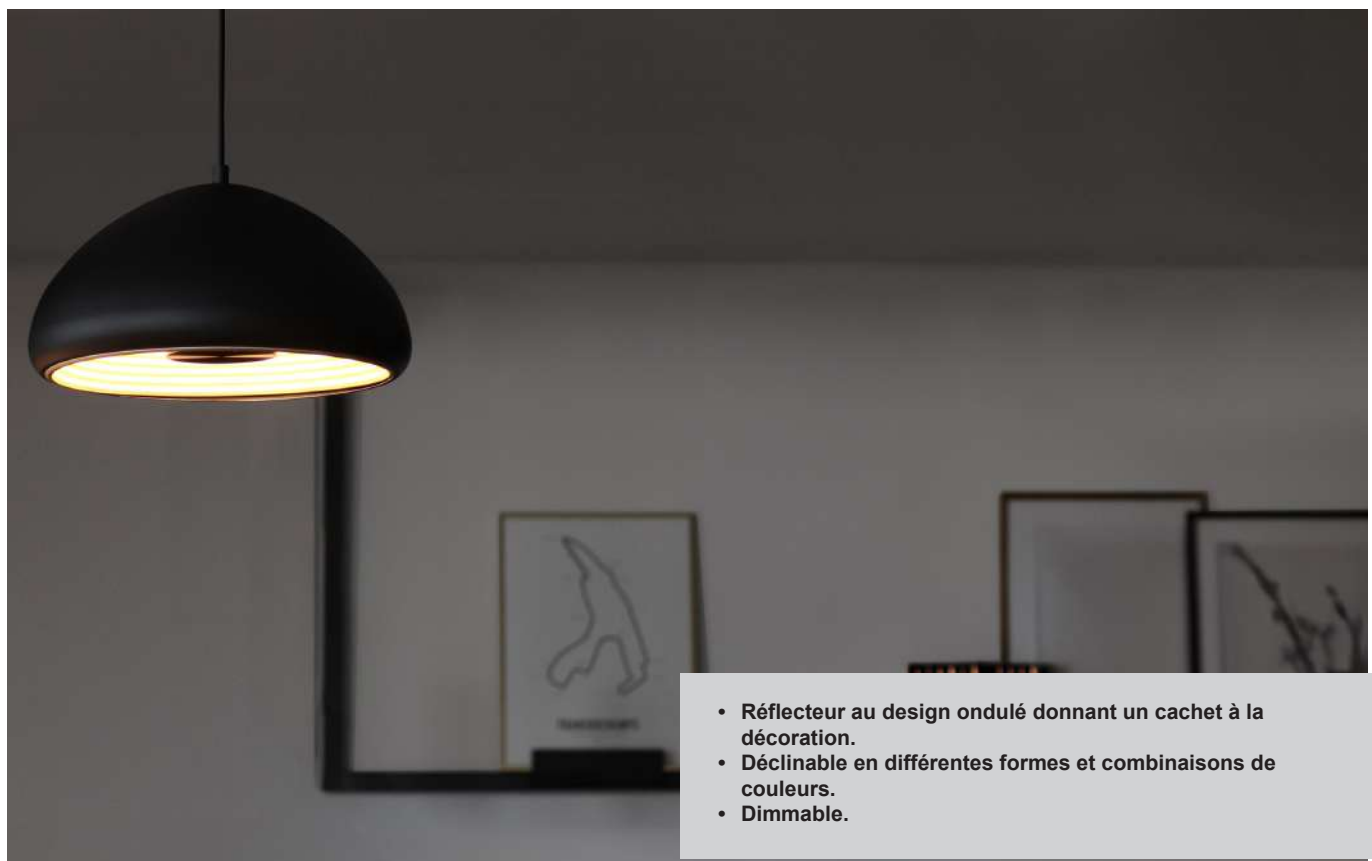

- Réflecteur au design ondulé donnant un cachet à la décoration.
- Déclinable en différentes formes et combinaisons de couleurs.
- Dimmable.



HULA P

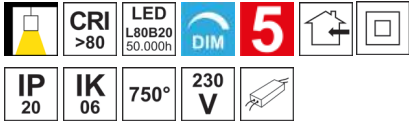

- Suspension décorative.
- Eclairage direct diffus via l'anneau externe et indirect via le réflecteur au design ondulé créant une ambiance agréable.
- Livrée avec câbles de suspension blancs ou noirs (réglables 1.50m max), base ronde et câble d'alimentation textile blancs ou noirs.
- Convertisseur dimmable intégré dans l'appareil.
- Compatible avec variateur début et fin de phase.



HULA P	COULEUR	MATIÈRE	P	CCT	LED LUMEN	SYSTEM LUMEN	α	€
SU174WW35	NOIR MAT - BLANC MAT	PLASTIQUE	18W	3000K	1850Lm	1000Lm	120°	165,00
SU174WW36	NOIR MAT - DORÉ	PLASTIQUE	18W	3000K	1850Lm	1000Lm	120°	165,00
SU174WW30	BLANC MAT	PLASTIQUE	18W	3000K	1850Lm	1000Lm	120°	165,00
SU174WW80	BLANC MAT - DORÉ	PLASTIQUE	18W	3000K	1850Lm	1000Lm	120°	165,00



DANS LA MÊME GAMME

HULA C PAGE 212



- Réflecteur au design ondulé donnant un cachet à la décoration.
- Déclinable en différentes formes et combinaisons de couleurs.
- Dimmable.

JUNE 1 P



- Suspension décorative.
- Diffuseur en PS opalin.
- 2700K, 3000K ou 4000K au choix via un interrupteur dans le luminaire.
- Livrée avec câbles de suspension blancs ou noirs (réglables 1.50m max), base ronde et câble d'alimentation blancs ou noirs.
- Convertisseur dimmable intégré dans l'appareil.
- Compatible avec variateur début et fin de phase.

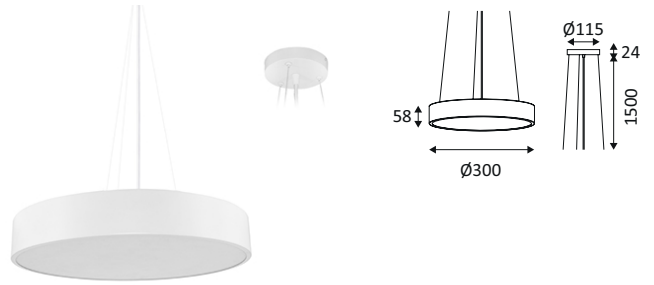

JUNE 1 P	COULEUR	MATIÈRE	P	CCT	LED LUMEN	SYSTEM LUMEN	α	€
SU15605	■ NOIR MAT	ALUMINIUM	18W	2700K 3000K 4000K	3300Lm (4000K)	1775Lm (4000K)	120°	136,00
SU15630	□ BLANC MAT	ALUMINIUM	18W	2700K 3000K 4000K	3300Lm (4000K)	1775Lm (4000K)	120°	136,00

DANS LA MÊME GAMME

JUNE 1 C PAGE 214



NOIR MAT

BLANC MAT

JUNE 2 P



- Suspension décorative.
- Diffuseur en PS opalin.
- 2700K, 3000K ou 4000K au choix via un interrupteur dans le luminaire.
- Livrée avec câbles de suspension blancs ou noirs (réglables 1.50m max), base ronde et câble d'alimentation blancs ou noirs.
- Convertisseur dimmable intégré dans l'appareil.
- Compatible avec variateur début et fin de phase.

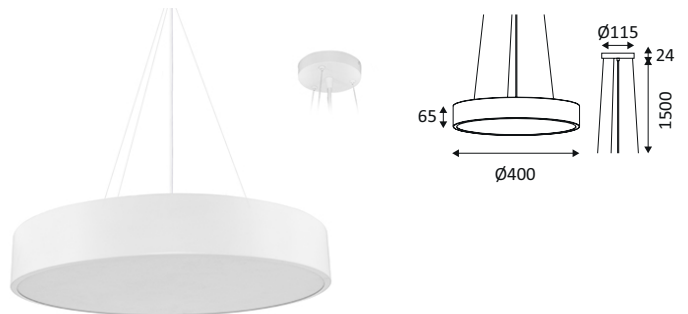

JUNE 2 P	COULEUR	MATIÈRE	P	CCT	LED LUMEN	SYSTEM LUMEN	α	€
SU15705	■ NOIR MAT	ALUMINIUM	30W	2700K 3000K 4000K	5600Lm (4000K)	3325Lm (4000K)	120°	195,00
SU15730	□ BLANC MAT	ALUMINIUM	30W	2700K 3000K 4000K	5600Lm (4000K)	3325Lm (4000K)	120°	195,00

DANS LA MÊME GAMME

JUNE 2 C PAGE 214



NOIR MAT

BLANC MAT



JUNE 3 P



- Suspension décorative.
- Diffuseur en PS opalin.
- 2700K, 3000K ou 4000K au choix via un interrupteur dans le luminaire.
- Livrée avec câbles de suspension blancs ou noirs (réglables 1.50m max), base ronde et câble d'alimentation blancs ou noirs.
- Convertisseur dimmable intégré dans l'appareil.
- Compatible avec variateur début et fin de phase.

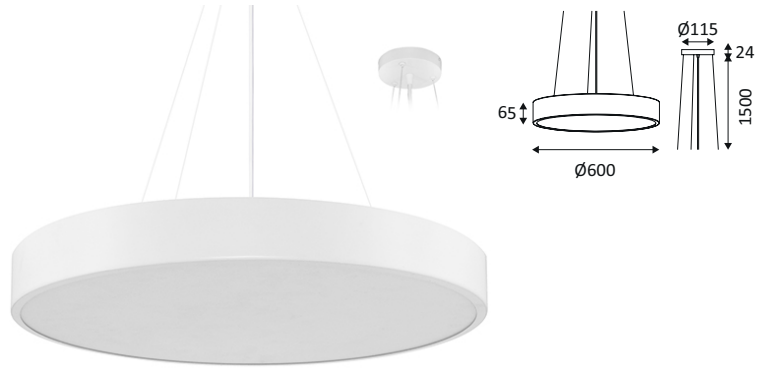

JUNE 3 P	COULEUR	MATIÈRE	P	CCT	LED LUMEN	SYSTEM LUMEN	α	€
SU16305	■ NOIR MAT	ALUMINIUM	50W	2700K 3000K 4000K	8000Lm (4000K)	5920Lm (4000K)	120°	334,00
SU16330	■ BLANC MAT	ALUMINIUM	50W	2700K 3000K 4000K	8000Lm (4000K)	5920Lm (4000K)	120°	334,00



NOIR MAT

BLANC MAT

DANS LA MÊME GAMME



JUNE 3 C PAGE 215

JUNE 2 P



CAPRI R 1 P



- Suspension ronde.
- Diffuseur PS à structure prismatique.
- 2700K, 3000K ou 4000K au choix via un interrupteur dans le luminaire.
- Livrée avec câbles de suspension en acier (réglables 2.00m max), base ronde et câble d'alimentation blancs ou noirs.
- Convertisseur dimmable coupure de phase ou dimmable DALI-push intégré dans l'appareil.

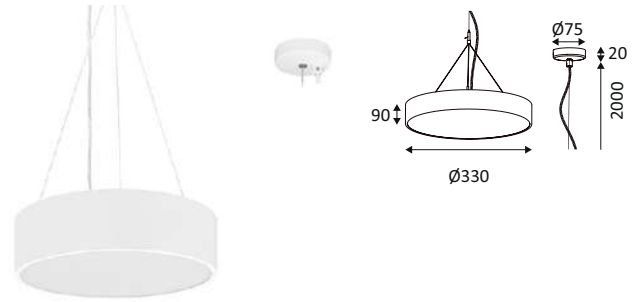

CAPRI R 1 P	COULEUR	MATIÈRE	P	CCT	LED LUMEN	SYSTEM LUMEN	α	€
DIMMABLE COUPURE DE PHASE								
SU15305	■ NOIR MAT	ALUMINIUM	20W	2700K 3000K 4000K	2400Lm (4000K)	1360Lm (4000K)	90°	300,00
SU15330	□ BLANC MAT	ALUMINIUM	20W	2700K 3000K 4000K	2400Lm (4000K)	1360Lm (4000K)	90°	300,00
DIMMABLE DALI								
SU15305DA	■ NOIR MAT	ALUMINIUM	20W	2700K 3000K 4000K	2400Lm (4000K)	1360Lm (4000K)	90°	400,00
SU15330DA	□ BLANC MAT	ALUMINIUM	20W	2700K 3000K 4000K	2400Lm (4000K)	1360Lm (4000K)	90°	400,00

DANS LA MÊME GAMME

CAPRI R 1 C PAGE 216



NOIR MAT

BLANC MAT

CAPRI R 2 P



- Suspension ronde.
- Diffuseur PS à structure prismatique.
- 2700K, 3000K ou 4000K au choix via un interrupteur dans le luminaire.
- Livrée avec câbles de suspension en acier (réglables 2.00m max), base ronde et câble d'alimentation blancs ou noirs.
- Convertisseur dimmable coupure de phase ou dimmable DALI-push intégré dans l'appareil.

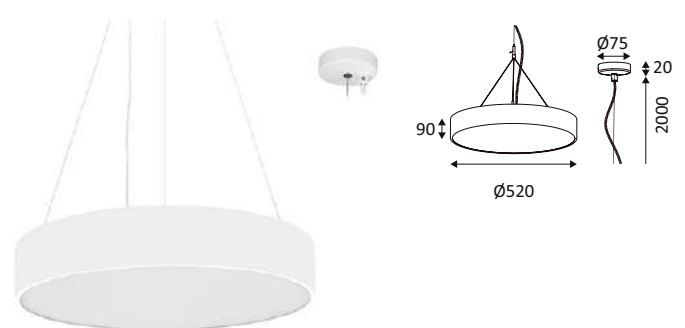

CAPRI R 2 P	COULEUR	MATIÈRE	P	CCT	LED LUMEN	SYSTEM LUMEN	α	€
DIMMABLE COUPURE DE PHASE								
SU15405	■ NOIR MAT	ALUMINIUM	42W	2700K 3000K 4000K	5150Lm (4000K)	2910Lm (4000K)	90°	440,00
SU15430	□ BLANC MAT	ALUMINIUM	42W	2700K 3000K 4000K	5150Lm (4000K)	2910Lm (4000K)	90°	440,00
DIMMABLE DALI								
SU15405DA	■ NOIR MAT	ALUMINIUM	42W	2700K 3000K 4000K	5150Lm (4000K)	2910Lm (4000K)	90°	540,00
SU15430DA	□ BLANC MAT	ALUMINIUM	42W	2700K 3000K 4000K	5150Lm (4000K)	2910Lm (4000K)	90°	540,00

DANS LA MÊME GAMME

CAPRI R 2 C PAGE 217

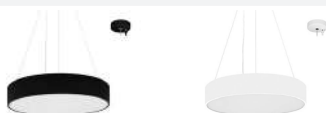

NOIR MAT

BLANC MAT



CAPRI R 3 P



- Suspension ronde.
- Diffuseur PS à structure prismatique.
- 2700K, 3000K ou 4000K au choix via un interrupteur dans le luminaire.
- Livrée avec câbles de suspension en acier (réglables 2.00m max), base ronde et câble d'alimentation blancs ou noirs.
- Convertisseur dimmable DALI intégré dans l'appareil.

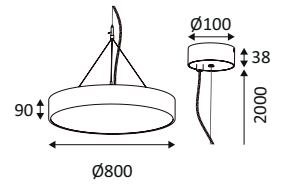

CAPRI R 3 P	COULEUR	MATIÈRE	P	CCT	LED LUMEN	SYSTEM LUMEN	α	€
DIMMABLE DALI								
SU15505DA	■ NOIR MAT	ALUMINIUM	105W	2700K 3000K 4000K	11800Lm (4000K)	7070Lm (4000K)	90°	1250,00
SU15530DA	■ BLANC MAT	ALUMINIUM	105W	2700K 3000K 4000K	11800Lm (4000K)	7070Lm (4000K)	90°	1250,00



NOIR MAT



BLANC MAT

DANS LA MÊME GAMME



CAPRI R 3 C PAGE 218



CAPRI S 1 P



- Suspension carrée.
- Diffuseur PS à structure prismatique.
- 2700K, 3000K ou 4000K au choix via un interrupteur dans le luminaire.
- Livrée avec câbles de suspension en acier (réglables 2.00m max), base ronde et câble d'alimentation blancs ou noirs.
- Convertisseur dimmable coupure de phase ou dimmable DALI-push intégré dans l'appareil.

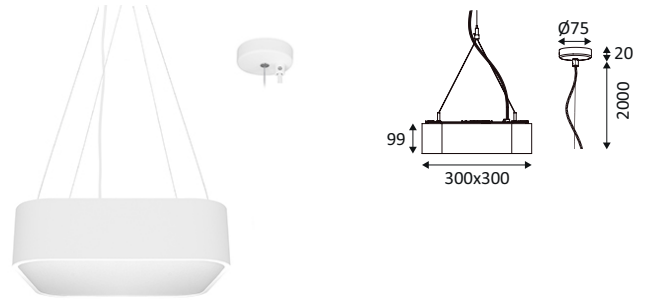

CAPRI S 1 P	COULEUR	MATIÈRE	P	CCT	L(MM)	LED LUMEN	SYSTEM LUMEN	α	€
DIMMABLE COUPURE DE PHASE									
SU16405	■ NOIR MAT	ALUMINIUM	20W	2700K 3000K 4000K	300	2400Lm (4000K)	1335Lm (4000K)	90°	340,00
SU16430	■ BLANC MAT	ALUMINIUM	20W	2700K 3000K 4000K	300	2400Lm (4000K)	1335Lm (4000K)	90°	340,00
DIMMABLE DALI									
SU16405DA	■ NOIR MAT	ALUMINIUM	20W	2700K 3000K 4000K	300	2400Lm (4000K)	1335Lm (4000K)	90°	440,00
SU16430DA	■ BLANC MAT	ALUMINIUM	20W	2700K 3000K 4000K	300	2400Lm (4000K)	1335Lm (4000K)	90°	440,00



NOIR MAT

BLANC MAT

DANS LA MÊME GAMME



CAPRI S 1 C PAGE 219

CAPRI S 2 P



- Suspension carrée.
- Diffuseur PS à structure prismatique.
- 2700K, 3000K ou 4000K au choix via un interrupteur dans le luminaire.
- Livrée avec câbles de suspension en acier (réglables 2.00m max), base ronde et câble d'alimentation blancs ou noirs.
- Convertisseur dimmable coupure de phase ou dimmable DALI-push intégré dans l'appareil.

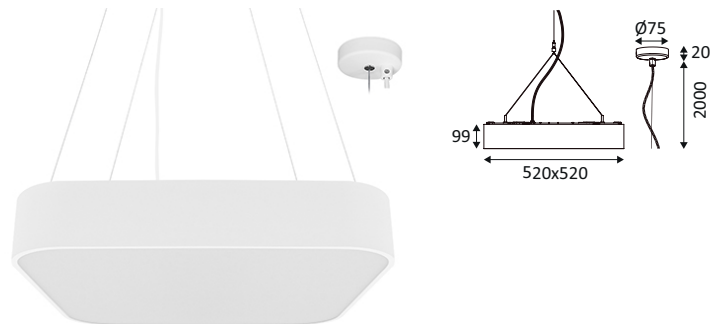

CAPRI S 2 P	COULEUR	MATIÈRE	P	CCT	L(MM)	LED LUMEN	SYSTEM LUMEN	α	€
DIMMABLE COUPURE DE PHASE									
SU16505	■ NOIR MAT	ALUMINIUM	42W	2700K 3000K 4000K	520	5150Lm (4000K)	3175Lm (4000K)	90°	480,00
SU16530	■ BLANC MAT	ALUMINIUM	42W	2700K 3000K 4000K	520	5150Lm (4000K)	3175Lm (4000K)	90°	480,00
DIMMABLE DALI									
SU16505DA	■ NOIR MAT	ALUMINIUM	42W	2700K 3000K 4000K	520	5150Lm (4000K)	3175Lm (4000K)	90°	580,00
SU16530DA	■ BLANC MAT	ALUMINIUM	42W	2700K 3000K 4000K	520	5150Lm (4000K)	3175Lm (4000K)	90°	580,00



NOIR MAT

BLANC MAT

DANS LA MÊME GAMME



CAPRI S 2 C PAGE 219



CAPRI S 2 P



NOVA CSP 1 P



- Suspension ronde.
- Diffuseur microprismatique.
- 2700K, 3000K ou 4000K au choix via un interrupteur dans le luminaire.
- Livrée avec câbles de suspension en acier (réglables 2.00m max), base ronde et câble d'alimentation blancs ou noirs.
- Convertisseur dimmable DALI, Push-Dim et 1-10V intégré dans l'appareil.
- Kit d'éclairage indirect non-dimmable en option.



NOVA CSP 1 P	COULEUR	MATIÈRE	P	CCT	LED LUMEN	SYSTEM LUMEN	α	€
SU17036	NOIR MAT - DORÉ	ALUMINIUM	26W	2700K 3000K 4000K	3930Lm (4000K)	3000Lm (4000K)	120°	630,00
SU17080	BLANC MAT - DORÉ	ALUMINIUM	26W	2700K 3000K 4000K	3930Lm (4000K)	3000Lm (4000K)	120°	630,00

ACCESSOIRES	MATIÈRE	DESCRIPTION	€
NV45UPM	POLYCARBONATE	KIT UPLIGHT 13W 3000K 1100Lm	130,00



NOIR MAT - DORÉ

BLANC MAT - DORÉ

DANS LA MÊME GAMME



NOVA CSP 1 C PAGE 220

NOVA CSP 2 P



- Suspension ronde.
- Diffuseur microprismatique.
- 2700K, 3000K ou 4000K au choix via un interrupteur dans le luminaire.
- Livrée avec câbles de suspension en acier (réglables 2.00m max), base ronde et câble d'alimentation blancs ou noirs.
- Convertisseur dimmable DALI, Push-Dim et 1-10V intégré dans l'appareil.
- Kit d'éclairage indirect non-dimmable en option.



NOVA CSP 2 P	COULEUR	MATIÈRE	P	CCT	LED LUMEN	SYSTEM LUMEN	α	€
SU17136	NOIR MAT - DORÉ	ALUMINIUM	40W	2700K 3000K 4000K	6075Lm	4800Lm	120°	830,00
SU17180	BLANC MAT - DORÉ	ALUMINIUM	40W	2700K 3000K 4000K	6075Lm	4800Lm	120°	830,00

ACCESSOIRES	MATIÈRE	DESCRIPTION	€
NV60UPM	POLYCARBONATE	KIT UPLIGHT 20W 3000K 1700Lm	188,00



NOIR MAT - DORÉ

BLANC MAT - DORÉ

DANS LA MÊME GAMME



NOVA CSP 2 C PAGE 220



NOVA CSP 3 P



- Suspension ronde.
- Diffuseur microprismatique.
- 2700K, 3000K ou 4000K au choix via un interrupteur dans le luminaire.
- Livrée avec câbles de suspension en acier (réglables 2.00m max), base ronde et câble d'alimentation blancs ou noirs.
- Convertisseur dimmable DALI, Push-Dim et 1-10V intégré dans l'appareil.
- Kit d'éclairage indirect non-dimmable en option.



NOVA CSP 3 P	COULEUR	MATIÈRE	P	CCT	LED LUMEN	SYSTEM LUMEN	α	€
SU17236	NOIR MAT - DORÉ	ALUMINIUM	68W	2700K 3000K 4000K	10740Lm (4000K)	9000Lm (4000K)	120°	1600,00
SU17280	BLANC MAT - DORÉ	ALUMINIUM	68W	2700K 3000K 4000K	10740Lm (4000K)	9000Lm (4000K)	120°	1600,00

ACCESSOIRES	MATIÈRE	DESCRIPTION	€
NV90UPM	POLYCARBONATE	KIT UPLIGHT 28W 3000K 2400Lm	285,00



NOIR MAT - DORÉ

BLANC MAT - DORÉ

DANS LA MÊME GAMME



NOVA CSP 3 C PAGE 221



NARIA 1 P



- Suspension circulaire.
- Diffuseur opalin.
- 3000K, 3500K ou 4000K au choix via un interrupteur dans la patère.
- Livrée avec câbles de suspension noirs ou blancs (réglables 2,50m max).
- Patère ronde pour montage en saillie.
- Convertisseur non-dimmable ou dimmable DALI intégré dans la patère.
- Panneau acoustique à placer au centre du cercle disponible en accessoire.

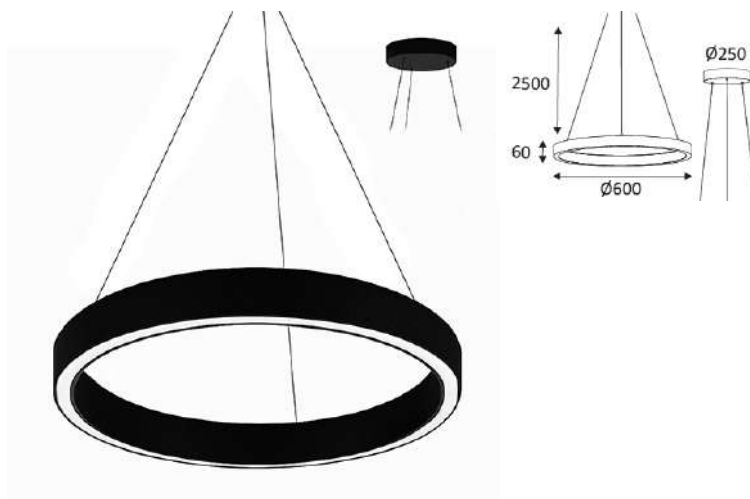

NARIA 1 P	COULEUR	MATIÈRE	P	CCT	LED LUMEN	SYSTEM LUMEN	α	€
NON DIMMABLE								
SU18805 NEW	NOIR MAT	ALUMINIUM	30W	3000K 3500K 4000K	5230Lm (4000K)	2850Lm (4000K)	100°	550,00
SU18830 NEW	BLANC MAT	ALUMINIUM	30W	3000K 3500K 4000K	5230Lm (4000K)	2850Lm (4000K)	100°	550,00
DIMMABLE DALI								
SU18905 NEW	NOIR MAT	ALUMINIUM	30W	3000K 3500K 4000K	5230Lm (4000K)	2850Lm (4000K)	100°	600,00
SU18930 NEW	BLANC MAT	ALUMINIUM	30W	3000K 3500K 4000K	5230Lm (4000K)	2850Lm (4000K)	100°	600,00

ACCESSOIRES	COULEUR	DESCRIPTION	€
SU19404 NEW	BLANC	PANNEAU ACOUSTIQUE POUR NARIA 1 P	150,00
SU19432 NEW	NOIR	PANNEAU ACOUSTIQUE POUR NARIA 1 P	150,00
SU19472 NEW	GRIS	PANNEAU ACOUSTIQUE POUR NARIA 1 P	150,00





NARIA 2 P



- Suspension circulaire.
- Diffuseur opalin.
- 3000K, 3500K ou 4000K au choix via un interrupteur dans la patère.
- Livrée avec câbles de suspension noirs ou blancs (réglables 2,50m max).
- Patère ronde pour montage en saillie.
- Convertisseur non-dimmable ou dimmable DALI intégré dans la patère.
- Panneau acoustique à placer au centre du cercle disponible en accessoire.



NARIA 2 P	COULEUR	MATIÈRE	P	CCT	LED LUMEN	SYSTEM LUMEN	α	€
NON DIMMABLE								
SU19005	NEW	NOIR MAT	ALUMINIUM	38W	3000K 3500K 4000K	6760Lm (4000K) 3740Lm (4000K)	100°	700,00
SU19030	NEW	BLANC MAT	ALUMINIUM	38W	3000K 3500K 4000K	6760Lm (4000K) 3740Lm (4000K)	100°	700,00
DIMMABLE DALI								
SU19105	NEW	NOIR MAT	ALUMINIUM	38W	3000K 3500K 4000K	6760Lm (4000K) 3740Lm (4000K)	100°	750,00
SU19130	NEW	BLANC MAT	ALUMINIUM	38W	3000K 3500K 4000K	6760Lm (4000K) 3740Lm (4000K)	100°	750,00

ACCESSOIRES	COULEUR	DESCRIPTION	€
SU19504	NEW	BLANC	250,00
SU19532	NEW	NOIR	250,00
SU19572	NEW	GRIS	250,00



NOIR MAT



BLANC MAT

NARIA 3 P



- Suspension circulaire.
- Diffuseur opalin.
- 3000K, 3500K ou 4000K au choix via un interrupteur dans la patère.
- Livrée avec câbles de suspension noirs ou blancs (réglables 2,50m max).
- Patère ronde pour montage en saillie.
- Convertisseur non-dimmable ou dimmable DALI intégré dans la patère.
- Panneau acoustique à placer au centre du cercle disponible en accessoire.

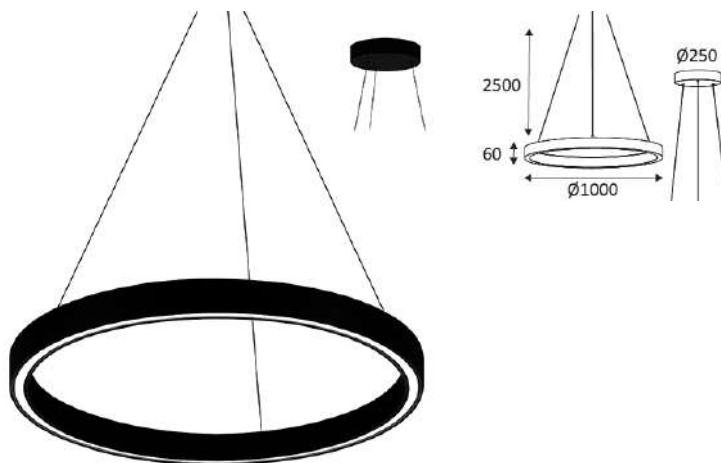

NARIA 3 P	COULEUR	MATIÈRE	P	CCT	LED LUMEN	SYSTEM LUMEN	α	€
NON DIMMABLE								
SU19205 NEW	NOIR MAT	ALUMINIUM	50W	3000K 3500K 4000K	8525Lm (4000K)	4770Lm (4000K)	100°	800,00
SU19230 NEW	BLANC MAT	ALUMINIUM	50W	3000K 3500K 4000K	8525Lm (4000K)	4770Lm (4000K)	100°	800,00
DIMMABLE DALI								
SU19305 NEW	NOIR MAT	ALUMINIUM	50W	3000K 3500K 4000K	8525Lm (4000K)	4770Lm (4000K)	100°	850,00
SU19330 NEW	BLANC MAT	ALUMINIUM	50W	3000K 3500K 4000K	8525Lm (4000K)	4770Lm (4000K)	100°	850,00

ACCESSOIRES	COULEUR	DESCRIPTION	€
SU19604 NEW	BLANC	PANNEAU ACOUSTIQUE POUR NARIA 3 P	300,00
SU19632 NEW	NOIR	PANNEAU ACOUSTIQUE POUR NARIA 3 P	300,00
SU19672 NEW	GRIS	PANNEAU ACOUSTIQUE POUR NARIA 3 P	300,00



NOIR MAT



BLANC MAT



NARIA 3 P



TOMY 1 P



- Suspension linéaire.
- Réflecteur basse luminance.
- 2700K, 3000K ou 4000K au choix via un interrupteur à l'arrière du luminaire.
- Livrée avec câbles de suspension blancs ou noirs (réglables 2.00m max), base ronde et câble d'alimentation blancs ou noirs.
- Convertisseur non dimmable intégré dans l'appareil.

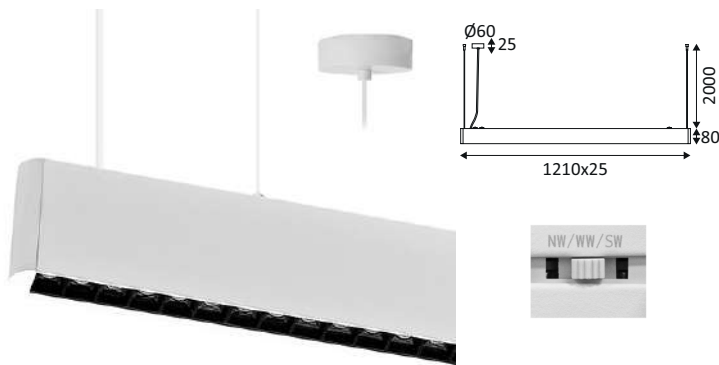

TOMY 1 P	COULEUR	MATIÈRE	P	CCT	L(MM)	LED LUMEN	SYSTEM LUMEN	α	€
SU15805	■ NOIR MAT	ALUMINIUM	36W	2700K 3000K 4000K	1210	4100Lm (4000K)	2835Lm (4000K)	36°	210,00
SU15830	□ BLANC MAT	ALUMINIUM	36W	2700K 3000K 4000K	1210	4100Lm (4000K)	2835Lm (4000K)	36°	210,00



NOIR MAT

BLANC MAT

DANS LA MÊME GAMME



TOMY 1 C PAGE 223

TOMY 2 P



- Suspension linéaire.
- Eclairage «up», «down» ou «up&down» au choix via un interrupteur à l'arrière du luminaire.
- Réflecteur basse luminance (éclairage vers le bas) et diffuseur en polycarbonate (éclairage vers le haut).
- 2700K, 3000K ou 4000K au choix via un interrupteur à l'arrière du luminaire.
- Livrée avec câbles de suspension blancs ou noirs (réglables 2.00m max), base ronde et câble d'alimentation blancs ou noirs.
- Convertisseur non dimmable intégré dans l'appareil.

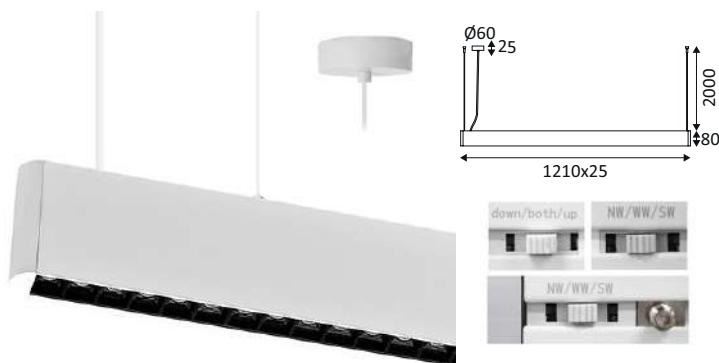

TOMY 2 P	COULEUR	MATIÈRE	P	CCT	L(MM)	LED LUMEN	SYSTEM LUMEN	α	€
SU15905	■ NOIR MAT	ALUMINIUM	72W	2700K 3000K 4000K	1210	4100+3800Lm (4000K)	2835+2430Lm (4000K)	100° 36°	290,00
SU15930	□ BLANC MAT	ALUMINIUM	72W	2700K 3000K 4000K	1210	4100+3800Lm (4000K)	2835+2430Lm (4000K)	100° 36°	290,00



NOIR MAT

BLANC MAT

DANS LA MÊME GAMME



TOMY 1 C PAGE 223



TOMY 2 P

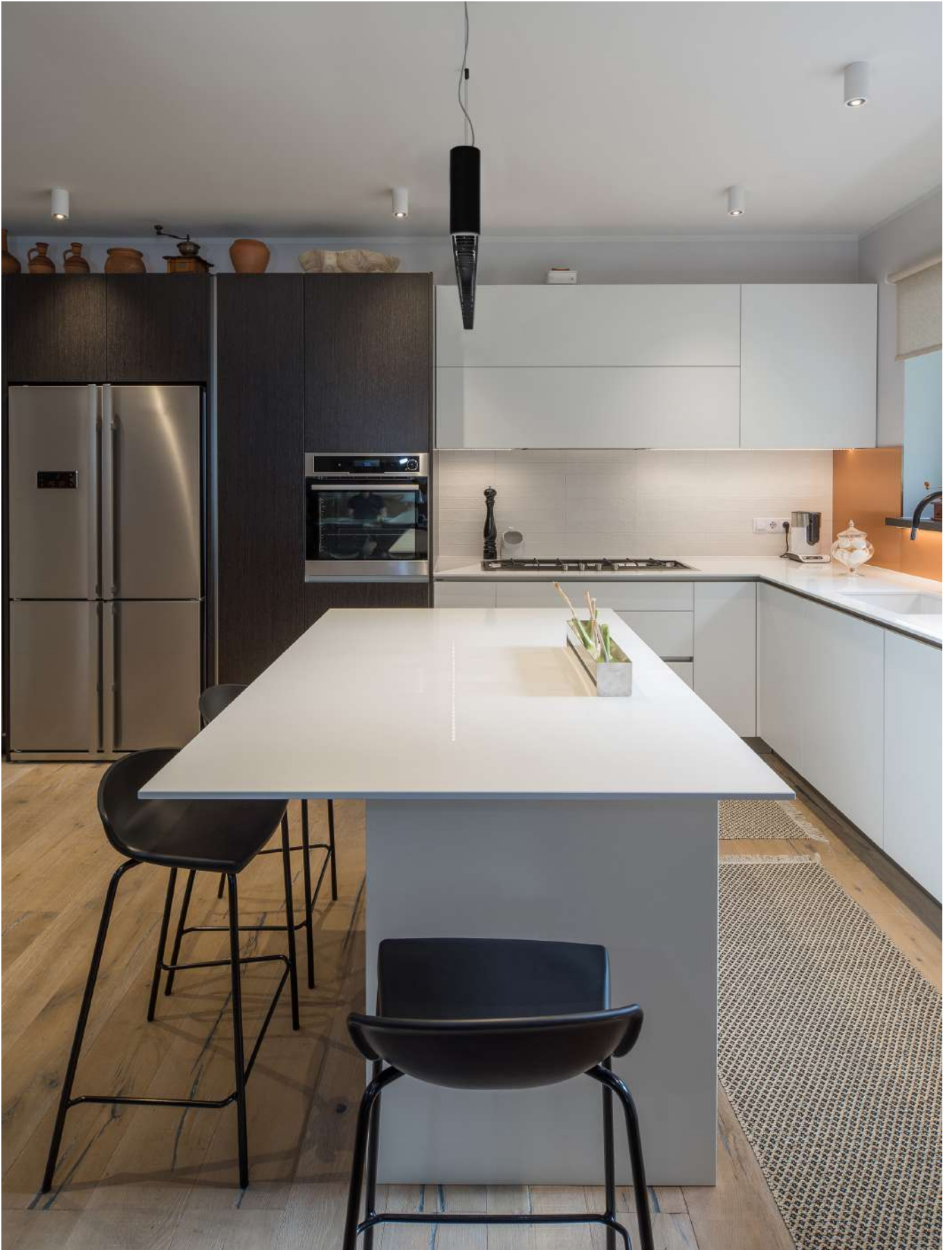

RAILS & PROJECTEURS

RAILS & PROJECTEURS

1 ALLUMAGE

TRACK UNO

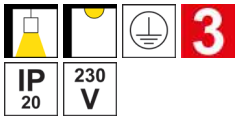

- Rail apparent.
- Tension secteur 220/250V.
- Le raccordement au monophasé autorise une intensité totale de 16A, qui correspond à 3680VA.
- Le rail peut supporter une charge de 10kg maximum entre 2 points de fixation.
- La pièce de renfort TR411 peut s'adapter au kit de suspension TR412.

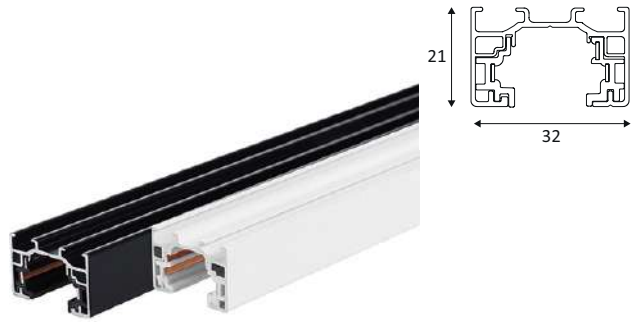

TRACK UNO	COULEUR	MATIÈRE	WATT MAX	L(MM)	€
TR40104	BLANC	ALUMINIUM	3680VA	2000	75,00
TR40105	NOIR	ALUMINIUM	3680VA	2000	75,00
TR40204	BLANC	ALUMINIUM	3680VA	3000	112,00
TR40205	NOIR	ALUMINIUM	3680VA	3000	112,00



BLANC

NOIR

ENTRAXES DE FIXATION

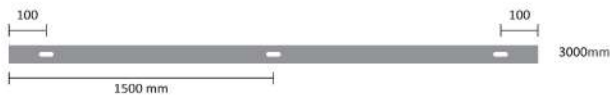

CHARGE SUPPORTÉE

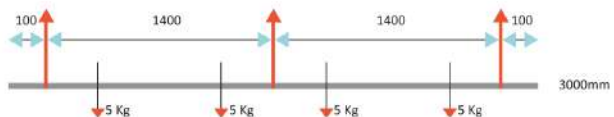
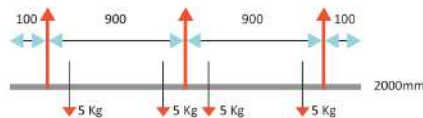

MONOPHASE

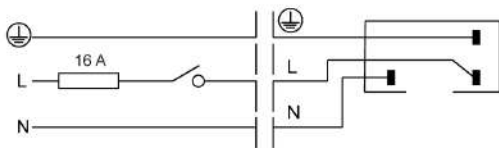

VUE EN PLAN

Les accessoires sont reliés aux rails de manière à assurer la continuité électrique et mécanique de l'installation, ainsi que la continuité de la mise à la terre.

La position latérale du fil de mise à la terre rend la structure asymétrique et, de ce fait, les raccords de connexion sont orientés gauche-droite ou intérieur-extérieur.

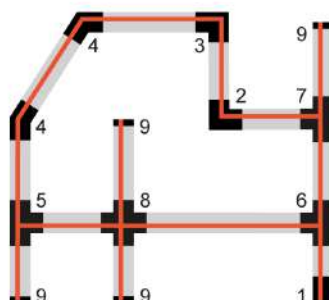

- 1 ALIMENTATION GAUCHE
- 2 CONNEXION L 90° INTERIEURE
- 3 CONNEXION L 90° EXTERIEURE
- 4 CONNEXION 20-180° EXTERIEURE
- 5 CONNEXION T EXTERIEURE DROITE
- 6 CONNEXION T INTERIEURE GAUCHE
- 7 CONNEXION T INTERIEURE DROITE
- 8 CONNEXION EN CROIX
- 9 EMBOUT DE FINITION



TRACK UNO

ALIMENTATION DROITE

	€
TR40304  	6,00
TR40305 	6,00

ALIMENTATION GAUCHE

TR40404  	6,00
TR40405 	6,00

ALIMENTATION CENTRALE

TR40504  	13,00
TR40505 	13,00

CONNEXION ELECTRIQUE

TR40604  	9,00
TR40605 	9,00

CONNEXION L 90° INTERIEURE

TR40704  	13,00
TR40705 	13,00

CONNEXION L 90° EXTERIEURE

TR40804  	13,00
TR40805 	13,00

CONNEXION 20-180° INTERIEURE

TR40904  	25,00
TR40905 	25,00

CONNEXION 20-180° EXTERIEURE

TR42104  	28,00
TR42105 	28,00



CONNEXION T INTERIEURE DROITE

TR44104  	16,50
TR44105 	16,50

CONNEXION T EXTERIEURE DROITE

TR44004  	16,50
TR44005 	16,50

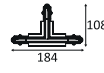
CONNEXION T INTERIEURE GAUCHE

TR44304  	16,50
TR44305 	16,50

CONNEXION T EXTERIEURE GAUCHE

TR44204  	16,50
TR44205 	16,50



CONNEXION EN CROIX

TR44404  	24,00
TR44405 	24,00

ADAPTATEUR 6A AVEC TUBE FILETE M10 MAX 5KG

TR41004  	6,00
TR41005 	6,00

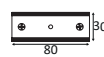
PIECE DE RENFORT L:8CM

TR41120  	10,00
TR41104 	9,00
TR41105 	9,00

KIT SUSPENSION L:150CM

TR41204  	22,00
TR41205 	22,00

EMBOUT DE FINITION



TR41304  	1,00
TR41305 	1,00

MOULURE DE FINITION L:200CM

TR41404  	19,00
---	-------

	€
TR41405 	19,00

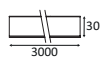
MOULURE DE FINITION L:300CM

TR41504  	28,00
TR41505 	28,00

YERA 1 T GU10



IP 20	IK 02	85°	355°	650°	230 V
----------	----------	-----	------	------	----------

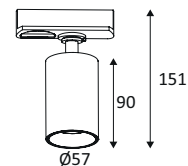

YERA 1 T GU10	COULEUR	MATIÈRE	DOUILLE	LAMPE	WATT MAX	€
TR43105	■ NOIR MAT	ALUMINIUM	GU10	PAR16 LED	10W	41,00
TR43130	■ BLANC MAT	ALUMINIUM	GU10	PAR16 LED	10W	41,00



NOIR MAT

BLANC MAT

YERA 1 TP GU10



IP 20	IK 02	650°	230 V
----------	----------	------	----------

- Suspension décorative.
- Adaptateur pour Track UNO.
- Livrée avec câble d'alimentation textile noir ou blanc (réglable 1.50m max).

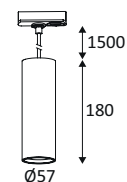

YERA 1 TP GU10	COULEUR	MATIÈRE	DOUILLE	LAMPE	WATT MAX	€
TR43205	■ NOIR MAT	ALUMINIUM	GU10	PAR16 LED	10W	71,00
TR43230	■ BLANC MAT	ALUMINIUM	GU10	PAR16 LED	10W	71,00



NOIR MAT

BLANC MAT



YERA 1 TP GU10



YERA 1 T GU10





JACK T

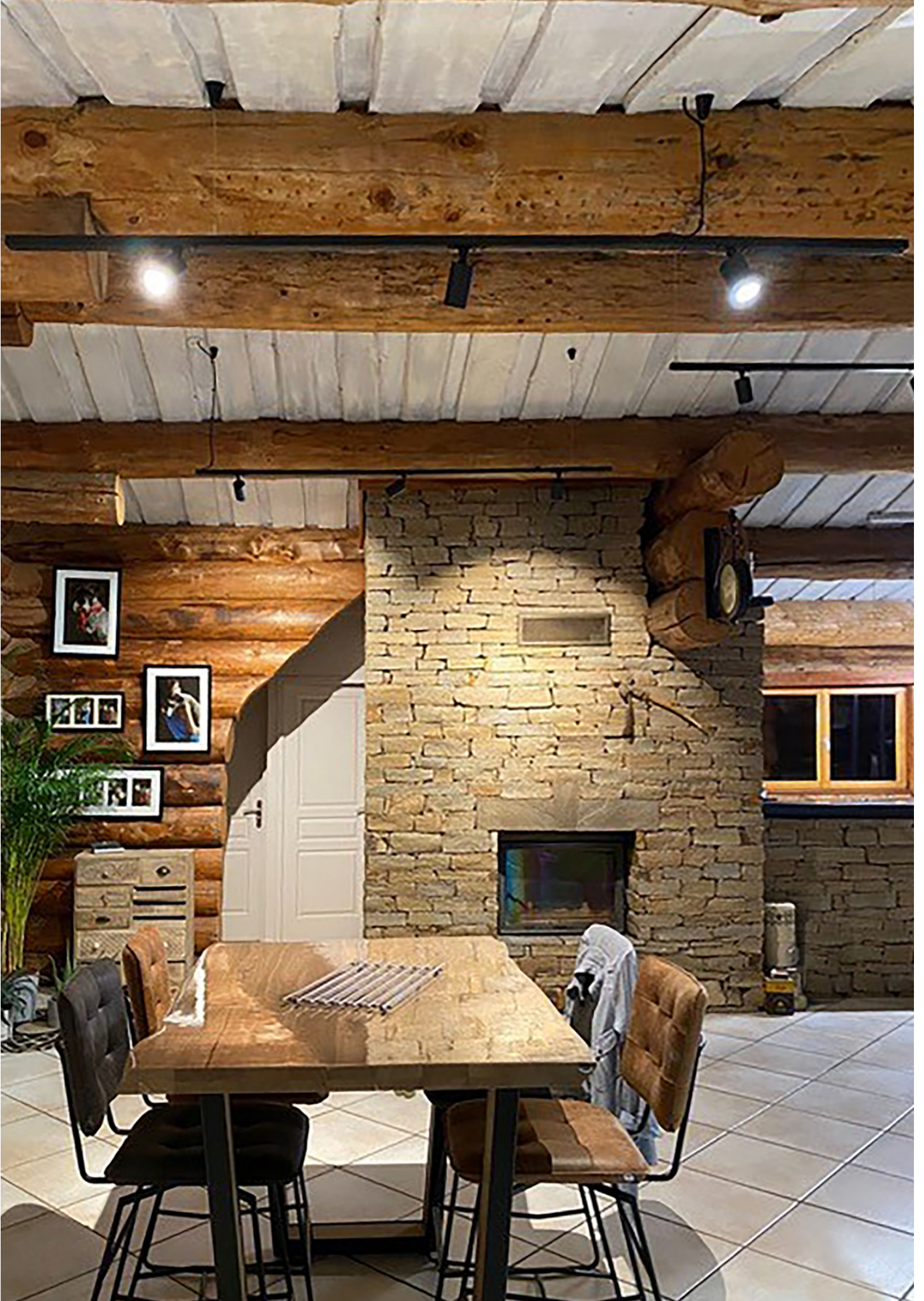

JACK T

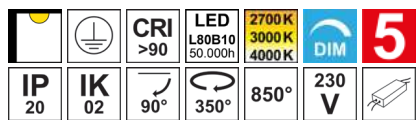

- Projecteur pour éclairage d'accentuation.
- Adaptateur pour Track UNO.
- 2700K, 3000K ou 4000K au choix via un interrupteur à l'arrière du luminaire.
- Convertisseur dimmable intégré dans l'appareil.
- Compatible avec variateur fin de phase.

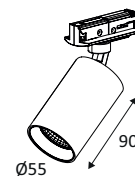

JACK T	COULEUR	MATIÈRE	P	CCT	LED LUMEN	SYSTEM LUMEN	α	€
TR42805	■ NOIR MAT	ALUMINIUM	10W	2700K 3000K 4000K	1120Lm (4000K)	770Lm (4000K)	38°	76,00
TR42813	■ NOIR MAT - LAITON	ALUMINIUM	10W	2700K 3000K 4000K	1120Lm (4000K)	770Lm (4000K)	38°	96,00
TR42806	■ NOIR MAT - OR ROSE	ALUMINIUM	10W	2700K 3000K 4000K	1120Lm (4000K)	770Lm (4000K)	38°	96,00
TR42830	■ BLANC MAT	ALUMINIUM	10W	2700K 3000K 4000K	1120Lm (4000K)	770Lm (4000K)	38°	76,00
TR42828	■ BLANC MAT - LAITON	ALUMINIUM	10W	2700K 3000K 4000K	1120Lm (4000K)	770Lm (4000K)	38°	96,00
TR42802	■ BLANC MAT - OR ROSE	ALUMINIUM	10W	2700K 3000K 4000K	1120Lm (4000K)	770Lm (4000K)	38°	96,00

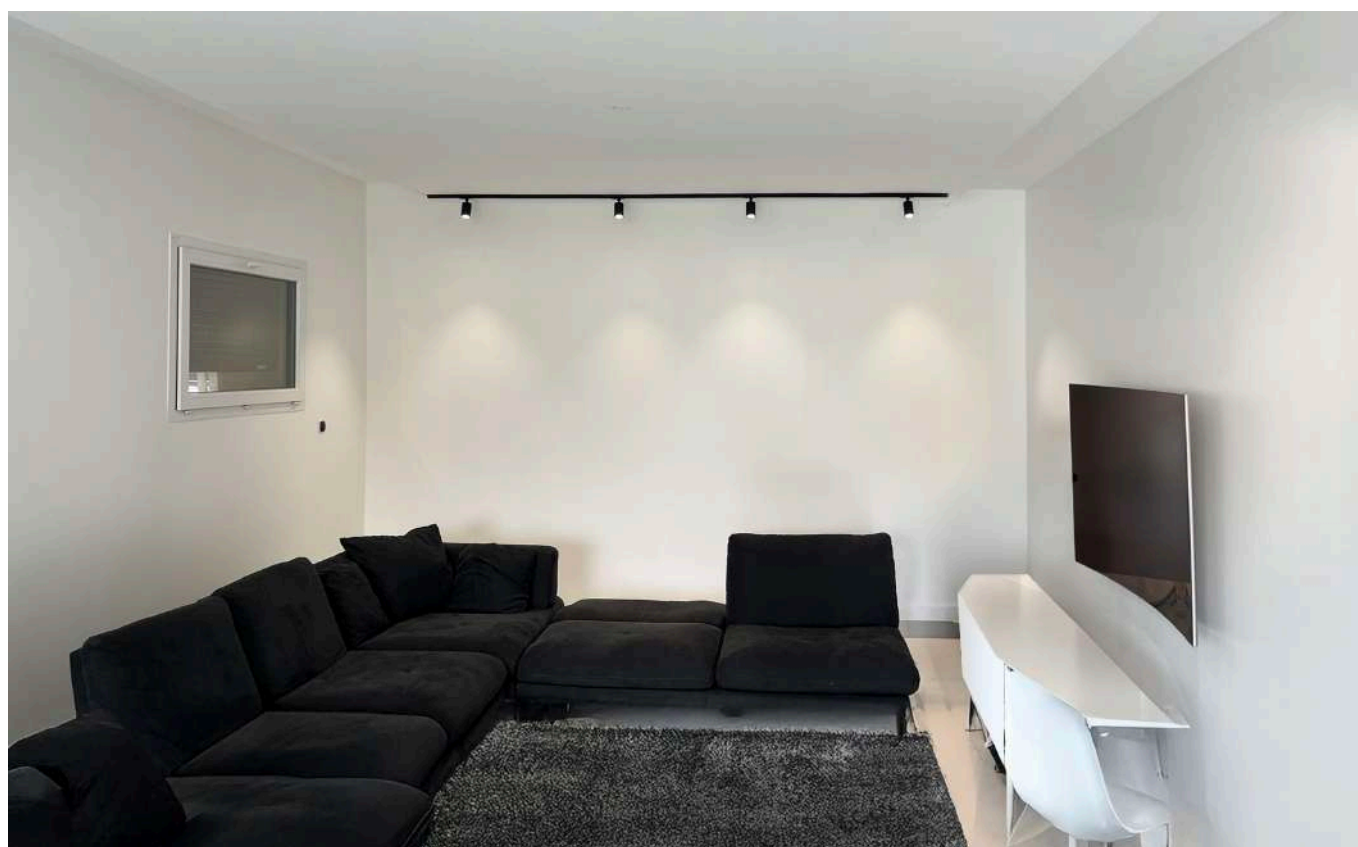



JACK TP

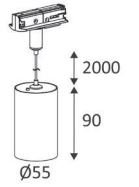
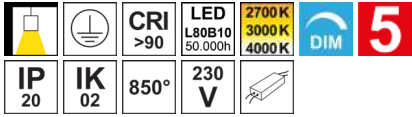

- Suspension décorative.
- Adaptateur pour Track UNO.
- Livrée avec câble d'alimentation (réglable 2.00m max).
- Coloris 05 - 13 - 06 : câble noir.
- Coloris 30 - 28 - 02 : câble blanc.
- 2700K, 3000K ou 4000K au choix via un interrupteur à l'arrière du luminaire.
- Convertisseur dimmable intégré dans l'appareil.
- Compatible avec variateur fin de phase.



JACK TP	COULEUR	MATIÈRE	P	CCT	LED LUMEN	SYSTEM LUMEN	α	€
TR42905	NOIR MAT	ALUMINIUM	10W	2700K 3000K 4000K	1120Lm (4000K)	770Lm (4000K)	38°	76,00
TR42913	NOIR MAT - LAITON	ALUMINIUM	10W	2700K 3000K 4000K	1120Lm (4000K)	770Lm (4000K)	38°	96,00
TR42906	NOIR MAT - OR ROSE	ALUMINIUM	10W	2700K 3000K 4000K	1120Lm (4000K)	770Lm (4000K)	38°	96,00
TR42930	BLANC MAT	ALUMINIUM	10W	2700K 3000K 4000K	1120Lm (4000K)	770Lm (4000K)	38°	76,00
TR42928	BLANC MAT - LAITON	ALUMINIUM	10W	2700K 3000K 4000K	1120Lm (4000K)	770Lm (4000K)	38°	96,00
TR42902	BLANC MAT - OR ROSE	ALUMINIUM	10W	2700K 3000K 4000K	1120Lm (4000K)	770Lm (4000K)	38°	96,00



RAY

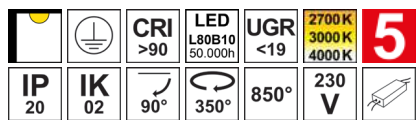

- Projecteur pour éclairage d'accentuation.
- Adaptateur pour Track UNO.
- 2700K, 3000K ou 4000K au choix via un interrupteur à l'arrière du luminaire.
- Convertisseur non dimmable ou dimmable intégré dans l'appareil.



RAY	COULEUR	MATIÈRE	P	CCT	LED LUMEN	SYSTEM LUMEN	α	€
NON DIMMABLE								
TR41805	■ NOIR MAT	ALUMINIUM	13W	2700K 3000K 4000K	1405Lm (4000K)	995Lm (4000K)	38°	96,00
TR41830	■ BLANC MAT	ALUMINIUM	13W	2700K 3000K 4000K	1405Lm (4000K)	1015Lm (4000K)	38°	96,00
DIMMABLE COUPURE DE PHASE								
TR43005	■ NOIR MAT	ALUMINIUM	15W	2700K 3000K 4000K	1580Lm (4000K)	1050Lm (4000K)	38°	111,00
TR43030	■ BLANC MAT	ALUMINIUM	15W	2700K 3000K 4000K	1580Lm (4000K)	1050Lm (4000K)	38°	111,00



NOIR MAT

BLANC MAT

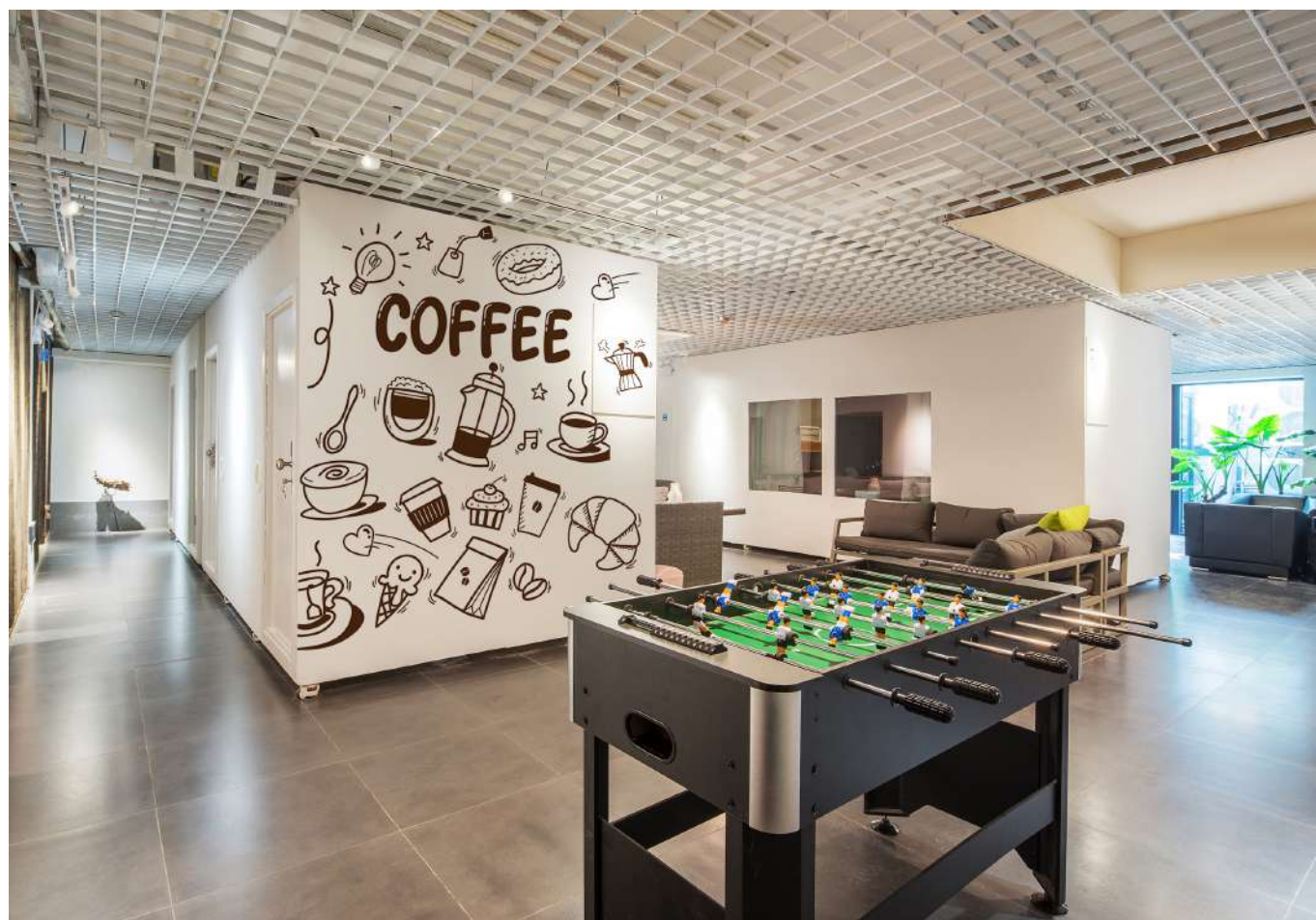

RAY

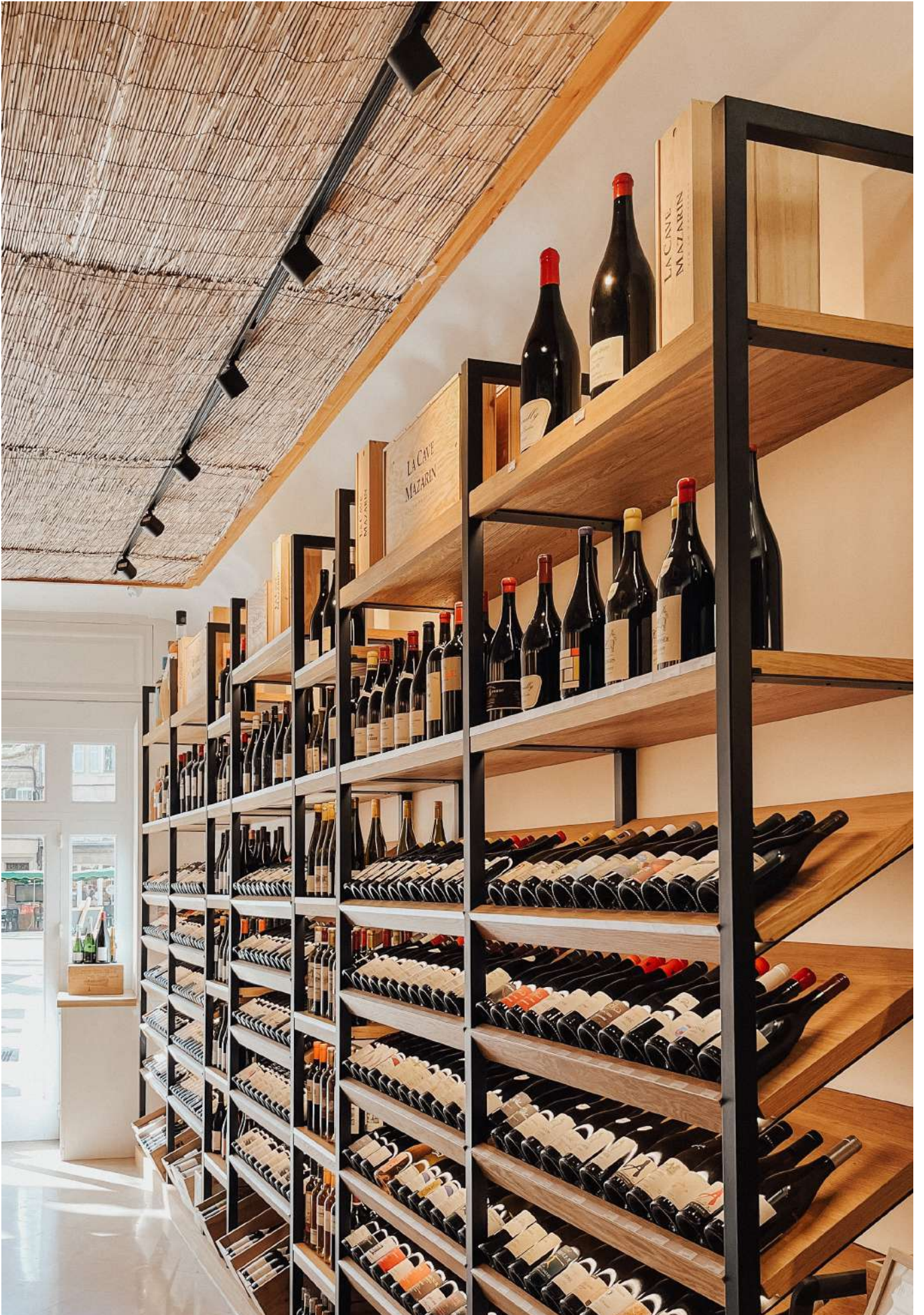

RAILS & PROJECTEURS

3 ALLUMAGES

TRACK III SURFACE

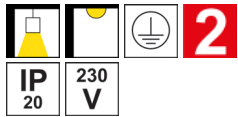

- Rail apparent.
- Tension secteur 220/250V.
- Le raccordement au triphasé autorise une intensité totale de 16A sur chaque circuit, ce qui correspond à 3 x 3680VA = 11040VA.
- Un rail peut supporter une charge de 6kg/0.20m avec une distance max de 1.00m entre les points de fixation ou une charge de 3kg/0.20m avec une distance max de 2.00m entre les points de fixation.

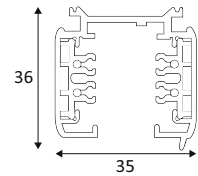

TRACK III SURFACE	COULEUR	MATIÈRE	WATT MAX	L(MM)	€
TR22030	NOIR	ALUMINIUM	(3X) 3680VA	1000	35,00
TR22031	BLANC	ALUMINIUM	(3X) 3680VA	1000	35,00
TR22130	NOIR	ALUMINIUM	(3X) 3680VA	2000	68,00
TR22131	BLANC	ALUMINIUM	(3X) 3680VA	2000	68,00
TR22230	NOIR	ALUMINIUM	(3X) 3680VA	3000	101,00
TR22231	BLANC	ALUMINIUM	(3X) 3680VA	3000	101,00



NOIR



BLANC

CHARGE POIDS D'INSTALLATION

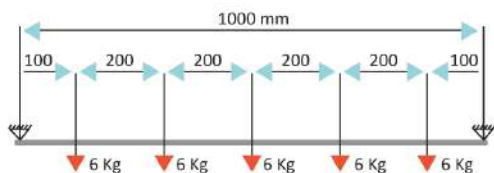

TRIPHASE

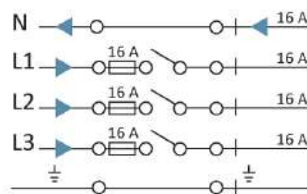

MONOPHASE

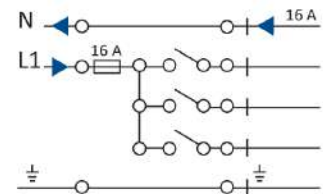

VUE EN PLAN

Les accessoires sont reliés aux rails de manière à assurer la continuité électrique et mécanique de l'installation, ainsi que la continuité de la mise à la terre.



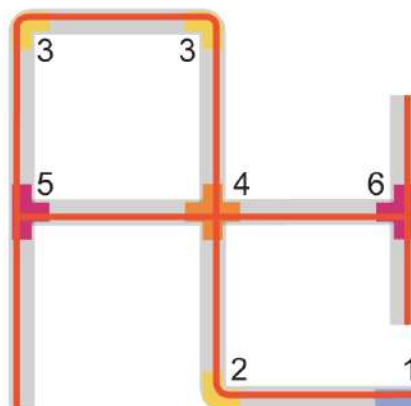













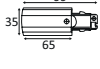





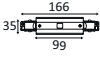





La position latérale du fil de mise à la terre rend la structure asymétrique et, de ce fait, les raccords de connexion sont orientés gauche-droite ou intérieur-extérieur.



- 1 ALIMENTATION DROITE
- 2 CONNEXION L 90° INTÉRIEURE
- 3 CONNEXION L 90° EXTÉRIEURE
- 4 CONNEXION EN CROIX
- 5 CONNEXION T DROITE
- 6 CONNEXION T GAUCHE



TRACK III SURFACE

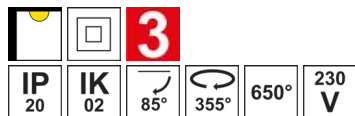

€		€		€	
ALIMENTATION DROITE		CONNEXION EN CROIX		KIT FIXATION PLAFOND	
TR22330	 	17,50	TR23030	 	49,00
TR22331	 	16,50	TR23031	 	49,00
ALIMENTATION GAUCHE		CONNEXION T DROITE		KIT SUSPENSION L:500CM	
TR22430	 	16,50	TR23130	 	42,00
TR22431	 	16,50	TR23131	 	42,00
ALIMENTATION CENTRALE		CONNEXION T GAUCHE		PIECE DE RENFORT L:18CM	
TR22530	 	29,00	TR23230	 	42,00
TR22531	 	29,00	TR23231	 	42,00
CONNEXION ELECTRIQUE		CONNEXION ELECTRIQUE SOUPLE		EMBOUT DE FINITION	
TR22630	 	9,25	TR36030	 	37,00
TR22631	 	9,25	TR36031	 	37,00
CONNEXION MECANIQUE		ADAPTATEUR MECANIQUE MAX. 10KG		MOULURE DE FINITION L:300CM	
TR22730	 	7,20	TR23330	 	13,25
TR22731	 	7,20	TR23331	 	13,25
CONNEXION L 90° INTERIEURE		ADAPTATEUR 10A MAX 5KG			
TR22830	 	29,00	TR23430	 	12,25
TR22831	 	29,00	TR23431	 	12,25
CONNEXION L 90° EXTERIEURE		CROCHET DE SUSPENSION MAX. 15KG			
TR22930	 	29,00	TR24030	 	2,00
TR22931	 	29,00	TR24031	 	2,00

YERA GU10

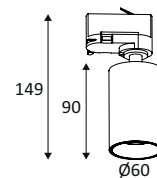

- Projecteur pour éclairage d'accentuation.
- Adaptateur pour Track III SURFACE.
- Base apparente TR241 à commander séparément.



YERA GU10	COULEUR	MATIÈRE	DOUILLE	LAMPE	WATT MAX	€
TR35905	■ NOIR MAT	ALUMINIUM	GU10	PAR16 LED	10W	53,00
TR35930	■ BLANC MAT	ALUMINIUM	GU10	PAR16 LED	10W	53,00
ACCESSOIRES	COULEUR	DESCRIPTION				€
TR24130	■ NOIR	BASE APPARENTE				30,00
TR24131	■ BLANC	BASE APPARENTE				30,00



NOIR MAT



BLANC MAT



YERA GU10



YERA GU10





AUREA 3 TP



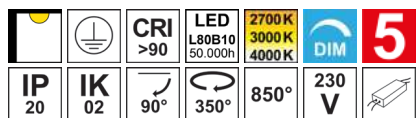

AUREA 3 T



- Projecteur pour éclairage d'accentuation.
- Adaptateur pour Track III SURFACE.
- 2700K, 3000K ou 4000K au choix via un interrupteur à l'arrière du luminaire.
- Convertisseur dimmable intégré dans l'appareil.
- Compatible avec variateur début de phase.
- Réserver une phase spécifique du rail pour les produits dimmables.
- Base apparente TR241 à commander séparément.



AUREA 3 T	COULEUR	MATIÈRE	P	CCT	LED LUMEN	SYSTEM LUMEN	α	€
TR43305	■ NOIR MAT	ALUMINIUM	6W	2700K 3000K 4000K	715Lm (4000K)	550Lm (4000K)	38°	82,00
TR43308	■ NOIR MAT - CHAMPAGNE	ALUMINIUM	6W	2700K 3000K 4000K	715Lm (4000K)	550Lm (4000K)	38°	97,00
TR43383	■ NOIR MAT - ROSE	ALUMINIUM	6W	2700K 3000K 4000K	715Lm (4000K)	550Lm (4000K)	38°	97,00
TR43330	■ BLANC MAT	ALUMINIUM	6W	2700K 3000K 4000K	715Lm (4000K)	550Lm (4000K)	38°	82,00
TR43349	■ BLANC MAT - CHAMPAGNE	ALUMINIUM	6W	2700K 3000K 4000K	715Lm (4000K)	550Lm (4000K)	38°	97,00
TR43382	■ BLANC MAT - ROSE	ALUMINIUM	6W	2700K 3000K 4000K	715Lm (4000K)	550Lm (4000K)	38°	97,00
ACCESSOIRES	COULEUR	DESCRIPTION						€
TR24130	NOIR	BASE APPARENTE						30,00
TR24131	BLANC	BASE APPARENTE						30,00



NOIR MAT

NOIR MAT -
CHAMPAGNE

NOIR MAT - ROSE

BLANC MAT

BLANC MAT -
CHAMPAGNE

BLANC MAT - ROSE



AUREA 3 TP

IP 20	IK 02	850°	230 V				

- Suspension décorative.
- Adaptateur pour Track III SURFACE.
- Livrée avec câble d'alimentation (réglable 2.00m max).
- Coloris 05 - 08 - 83 : câble noir.
- Coloris 30 - 49 - 82 : câble blanc.
- 2700K, 3000K ou 4000K au choix via un interrupteur à l'arrière du luminaire.
- Convertisseur dimmable intégré dans l'appareil.
- Compatible avec variateur début de phase.
- Réserver une phase spécifique du rail pour les produits dimmables.

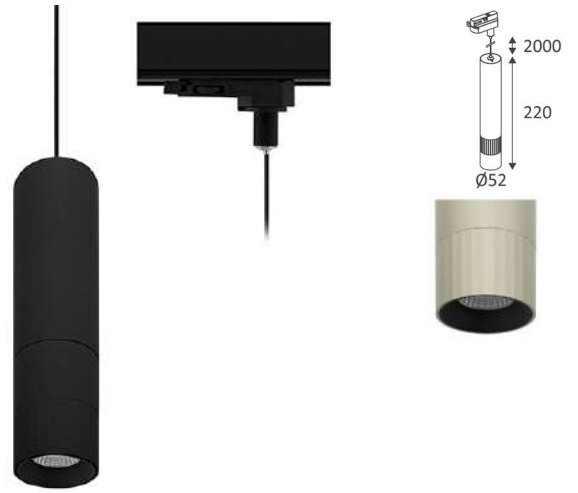

AUREA 3 TP	COULEUR	MATIÈRE	P	CCT	LED LUMEN	SYSTEM LUMEN	α	€
TR43405	NOIR MAT	ALUMINIUM	6W	2700K 3000K 4000K	715Lm (4000K)	550Lm (4000K)	38°	122,00
TR43408	NOIR MAT - CHAMPAGNE	ALUMINIUM	6W	2700K 3000K 4000K	715Lm (4000K)	550Lm (4000K)	38°	137,00
TR43483	NOIR MAT - ROSE	ALUMINIUM	6W	2700K 3000K 4000K	715Lm (4000K)	550Lm (4000K)	38°	137,00
TR43430	BLANC MAT	ALUMINIUM	6W	2700K 3000K 4000K	715Lm (4000K)	550Lm (4000K)	38°	122,00
TR43449	BLANC MAT - CHAMPAGNE	ALUMINIUM	6W	2700K 3000K 4000K	715Lm (4000K)	550Lm (4000K)	38°	137,00
TR43482	BLANC MAT - ROSE	ALUMINIUM	6W	2700K 3000K 4000K	715Lm (4000K)	550Lm (4000K)	38°	137,00

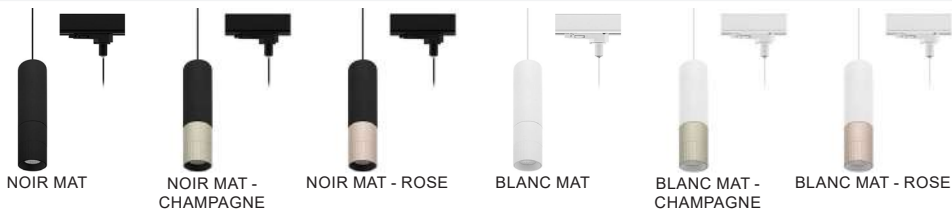

OLYN 3 T

	CRI >90	LED L80B10 50.000h	UGR <10	5			3000K 3500K 4000K
90°	350°	850°	230 V		IP 20	IK 03	

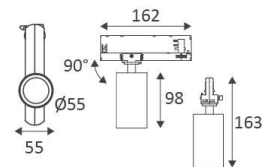

- Projecteur pour éclairage d'accentuation.
- Adaptateur pour Track III SURFACE.
- 3000K, 3500K ou 4000K au choix via un interrupteur sur le driver.
- Convertisseur non dimmable intégré dans l'appareil.
- Très basse luminance grâce à un design d'optique à réflexion totale interne.

OLYN 3 T	COULEUR	MATIÈRE	P	CCT	LED LUMEN	SYSTEM LUMEN	α	€
TR50405 NEW	NOIR MAT	ALUMINIUM	15W	3000K 3500K 4000K	1820Lm (4000K)	1340Lm (4000K)	36°	110,00
TR50430 NEW	BLANC MAT	ALUMINIUM	15W	3000K 3500K 4000K	1820Lm (4000K)	1340Lm (4000K)	36°	110,00
TR50431 NEW	NOIR MAT - BRONZE SATINÉ	ALUMINIUM	15W	3000K 3500K 4000K	1820Lm (4000K)	1340Lm (4000K)	36°	130,00
TR50451 NEW	BLANC MAT - ROSE BROSSÉ	ALUMINIUM	15W	3000K 3500K 4000K	1820Lm (4000K)	1340Lm (4000K)	36°	130,00
TR50456 NEW	BLANC MAT - NICKEL BROSSÉ	ALUMINIUM	15W	3000K 3500K 4000K	1820Lm (4000K)	1340Lm (4000K)	36°	130,00
TR50457 NEW	NOIR MAT - NICKEL BROSSÉ	ALUMINIUM	15W	3000K 3500K 4000K	1820Lm (4000K)	1340Lm (4000K)	36°	130,00
TR50459 NEW	BLANC MAT - OR BROSSÉ	ALUMINIUM	15W	3000K 3500K 4000K	1820Lm (4000K)	1340Lm (4000K)	36°	130,00
TR50465 NEW	BLANC MAT - BRONZE SATINÉ	ALUMINIUM	15W	3000K 3500K 4000K	1820Lm (4000K)	1340Lm (4000K)	36°	130,00
TR50467 NEW	NOIR MAT - ROSE BROSSÉ	ALUMINIUM	15W	3000K 3500K 4000K	1820Lm (4000K)	1340Lm (4000K)	36°	130,00
TR50468 NEW	NOIR MAT - OR BROSSÉ	ALUMINIUM	15W	3000K 3500K 4000K	1820Lm (4000K)	1340Lm (4000K)	36°	130,00



DANS LA MÊME GAMME

- OLYN 1 W PAGE 168
- OLYN 2 RDX PAGE 99
- OLYN 2 C PAGE 204
- OLYN 2 P PAGE 229
- OLYN 1 RDX PAGE 98
- OLYN 1 P PAGE 228



OLYN 3 T



HELLO 1 D



- Projecteur pour éclairage diffus.
- Adaptateur pour Track III SURFACE.
- Convertisseur dimmable intégré dans l'appareil.
- Compatible avec variateur fin de phase.
- Réserver une phase spécifique du rail pour les produits dimmables.

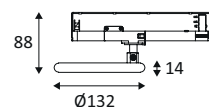

HELLO 1 D	COULEUR	MATIÈRE	P	CCT	LED LUMEN	SYSTEM LUMEN	α	€
TR389WW05	NOIR MAT	ALUMINIUM	10W	3000K	1300Lm	825Lm	100°	138,00
TR389WW30	BLANC MAT	ALUMINIUM	10W	3000K	1300Lm	825Lm	100°	138,00



NOIR MAT

BLANC MAT

DANS LA MÊME GAMME

HELLO 1 P PAGE 239

HELLO 2 D

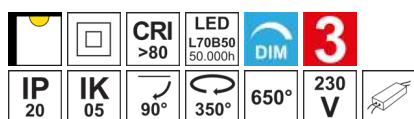

- Projecteur pour éclairage diffus.
- Adaptateur pour Track III SURFACE.
- Convertisseur dimmable intégré dans l'appareil.
- Compatible avec variateur fin de phase.
- Réserver une phase spécifique du rail pour les produits dimmables.

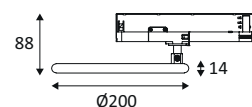

HELLO 2 D	COULEUR	MATIÈRE	P	CCT	LED LUMEN	SYSTEM LUMEN	α	€
TR390WW05	NOIR MAT	ALUMINIUM	17W	3000K	2160Lm	1740Lm	100°	192,00
TR390WW30	BLANC MAT	ALUMINIUM	17W	3000K	2160Lm	1740Lm	100°	192,00



NOIR MAT

BLANC MAT

DANS LA MÊME GAMME

HELLO 2 P PAGE 239



HELLO 2 D



OSIS 2 PLUS





OSIS 1 PLUS

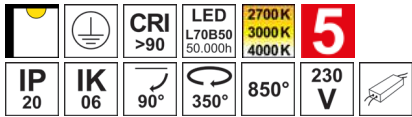

- Projecteur pour éclairage d'accentuation.
- Adaptateur pour Track III SURFACE.
- 2700K, 3000K ou 4000K au choix via un interrupteur sur l'adaptateur.
- Convertisseur non dimmable intégré dans l'appareil.



OSIS 1 PLUS	COULEUR	MATIÈRE	P	CCT	LED LUMEN	SYSTEM LUMEN	α	€
TR43805	■ NOIR MAT	FONTE D'ALUMINIUM	25W	2700K 3000K 4000K	3200Lm (4000K)	2100Lm (4000K)	60°	89,00
TR43830	■ BLANC MAT	FONTE D'ALUMINIUM	25W	2700K 3000K 4000K	3200Lm (4000K)	2210Lm (4000K)	60°	89,00



NOIR MAT

BLANC MAT

OSIS 2 PLUS

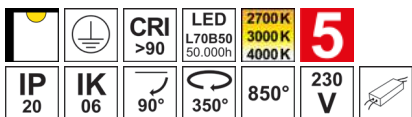

- Projecteur pour éclairage d'accentuation.
- Adaptateur pour Track III SURFACE.
- 2700K, 3000K ou 4000K au choix via un interrupteur sur l'adaptateur.
- Convertisseur non dimmable intégré dans l'appareil.



OSIS 2 PLUS	COULEUR	MATIÈRE	P	CCT	LED LUMEN	SYSTEM LUMEN	α	€
TR43905	■ NOIR MAT	FONTE D'ALUMINIUM	40W	2700K 3000K 4000K	5250Lm (4000K)	3420Lm (4000K)	60°	106,00
TR43930	■ BLANC MAT	FONTE D'ALUMINIUM	40W	2700K 3000K 4000K	5250Lm (4000K)	4000Lm (4000K)	60°	106,00



NOIR MAT

BLANC MAT

TED

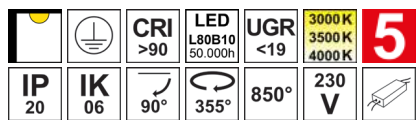

- Projecteur pour éclairage d'accentuation.
- Adaptateur pour Track III SURFACE.
- 3000K, 3500K ou 4000K au choix via un interrupteur à l'arrière du luminaire.
- Convertisseur non dimmable intégré dans l'appareil.

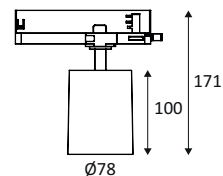

TED	COULEUR	MATIÈRE	P	CCT	LED LUMEN	SYSTEM LUMEN	α	€
TR43505	■ NOIR MAT	ALUMINIUM	28W	3000K 3500K 4000K	3000Lm (4000K)	2140Lm (4000K)	45°	117,00
TR43530	□ BLANC MAT	ALUMINIUM	28W	3000K 3500K 4000K	3000Lm (4000K)	2140Lm (4000K)	45°	117,00



NOIR MAT



BLANC MAT

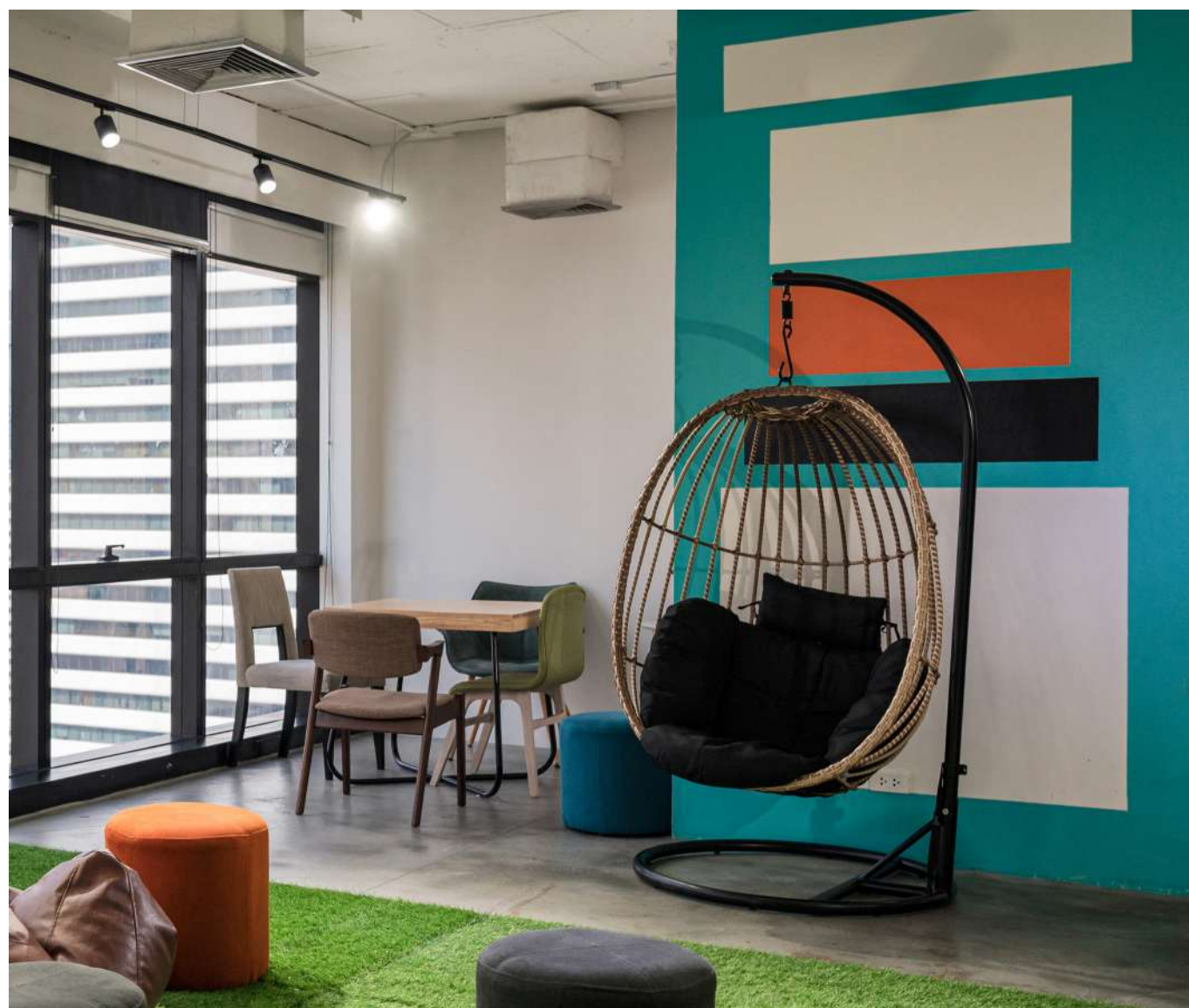



FOCAL

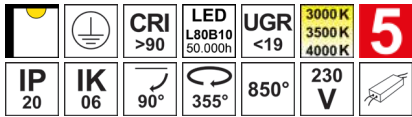

- Projecteur pour éclairage d'accentuation.
- Adaptateur pour Track III SURFACE.
- 3000K, 3500K ou 4000K au choix via un interrupteur à l'arrière du luminaire.
- Faisceau ajustable de 30° à 60°.
- Convertisseur non dimmable intégré dans l'appareil.

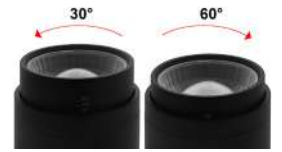
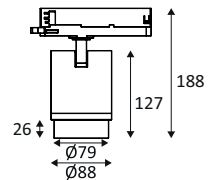

FOCAL	COULEUR	MATIÈRE	P	CCT	LED LUMEN	SYSTEM LUMEN	α	€
TR43705	NOIR MAT	ALUMINIUM	32W	3000K 3500K 4000K	3550Lm (4000K)	2535Lm (4000K)	30-60°	140,00
TR43730	BLANC MAT	ALUMINIUM	32W	3000K 3500K 4000K	3550Lm (4000K)	2535Lm (4000K)	30-60°	140,00



NOIR MAT



BLANC MAT

FOCUS

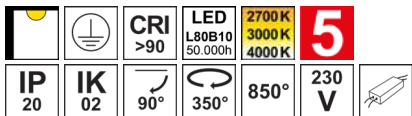

- Projecteur pour éclairage d'accentuation.
- Adaptateur pour Track III SURFACE.
- 2700K, 3000K ou 4000K au choix via un interrupteur à l'arrière du luminaire.
- Faisceau ajustable de 15° à 35° (TR393), ou de 35° à 60° (TR394).
- Convertisseur non dimmable intégré dans l'appareil.
- Base apparente TR241 à commander séparément.

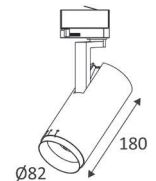

FOCUS	COULEUR	MATIÈRE	P	CCT	LED LUMEN	SYSTEM LUMEN	α	€
TR39305	NOIR MAT	ALUMINIUM	35W	2700K 3000K 4000K	5400Lm (4000K)	4260Lm (4000K)	15-35°	203,00
TR39330	BLANC MAT	ALUMINIUM	35W	2700K 3000K 4000K	2815Lm (4000K)	2430Lm (4000K)	15-35°	203,00

ACCESSOIRES	COULEUR	DESCRIPTION	€
TR24130	NOIR	BASE APPARENTE	30,00
TR24131	BLANC	BASE APPARENTE	30,00



NOIR MAT



BLANC MAT

JACK 3 T

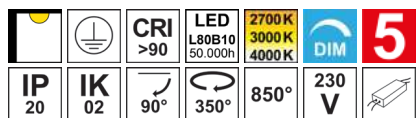

- Projecteur pour éclairage d'accentuation.
- Adaptateur pour Track III SURFACE.
- 2700K, 3000K ou 4000K au choix via un interrupteur à l'arrière du luminaire.
- Convertisseur dimmable intégré dans l'appareil.
- Compatible avec variateur fin de phase.
- Réserver une phase spécifique du rail pour les produits dimmables.
- Base apparente TR241 à commander séparément.

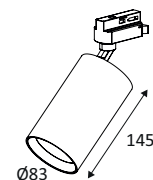

JACK 3 T	COULEUR	MATIÈRE	P	CCT	LED LUMEN	SYSTEM LUMEN	α	€
TR42405	NOIR MAT	ALUMINIUM	30W	2700K 3000K 4000K	3310Lm (4000K)	2700Lm (4000K)	40°	213,00
TR42413	NOIR MAT - LAITON	ALUMINIUM	30W	2700K 3000K 4000K	3310Lm (4000K)	2700Lm (4000K)	40°	243,00
TR42406	NOIR MAT - OR ROSE	ALUMINIUM	30W	2700K 3000K 4000K	3310Lm (4000K)	2700Lm (4000K)	40°	243,00
TR42430	BLANC MAT	ALUMINIUM	30W	2700K 3000K 4000K	3310Lm (4000K)	2700Lm (4000K)	40°	213,00
TR42428	BLANC MAT - LAITON	ALUMINIUM	30W	2700K 3000K 4000K	3310Lm (4000K)	2700Lm (4000K)	40°	243,00
TR42402	BLANC MAT - OR ROSE	ALUMINIUM	30W	2700K 3000K 4000K	3310Lm (4000K)	2700Lm (4000K)	40°	243,00
TR42505	NOIR MAT	ALUMINIUM	30W	2700K 3000K 4000K	3310Lm (4000K)	2615Lm (4000K)	60°	213,00
TR42513	NOIR MAT - LAITON	ALUMINIUM	30W	2700K 3000K 4000K	3310Lm (4000K)	2615Lm (4000K)	60°	243,00
TR42506	NOIR MAT - OR ROSE	ALUMINIUM	30W	2700K 3000K 4000K	3310Lm (4000K)	2615Lm (4000K)	60°	243,00
TR42530	BLANC MAT	ALUMINIUM	30W	2700K 3000K 4000K	3310Lm (4000K)	2615Lm (4000K)	60°	213,00
TR42528	BLANC MAT - LAITON	ALUMINIUM	30W	2700K 3000K 4000K	3310Lm (4000K)	2615Lm (4000K)	60°	243,00
TR42502	BLANC MAT - OR ROSE	ALUMINIUM	30W	2700K 3000K 4000K	3310Lm (4000K)	2615Lm (4000K)	60°	243,00

ACCESSOIRES	COULEUR	DESCRIPTION	€
TR24130	NOIR	BASE APPARENTE	30,00
TR24131	BLANC	BASE APPARENTE	30,00



DANS LA MÊME GAMME



JACK 3 P PAGE 230



JACK 3 T

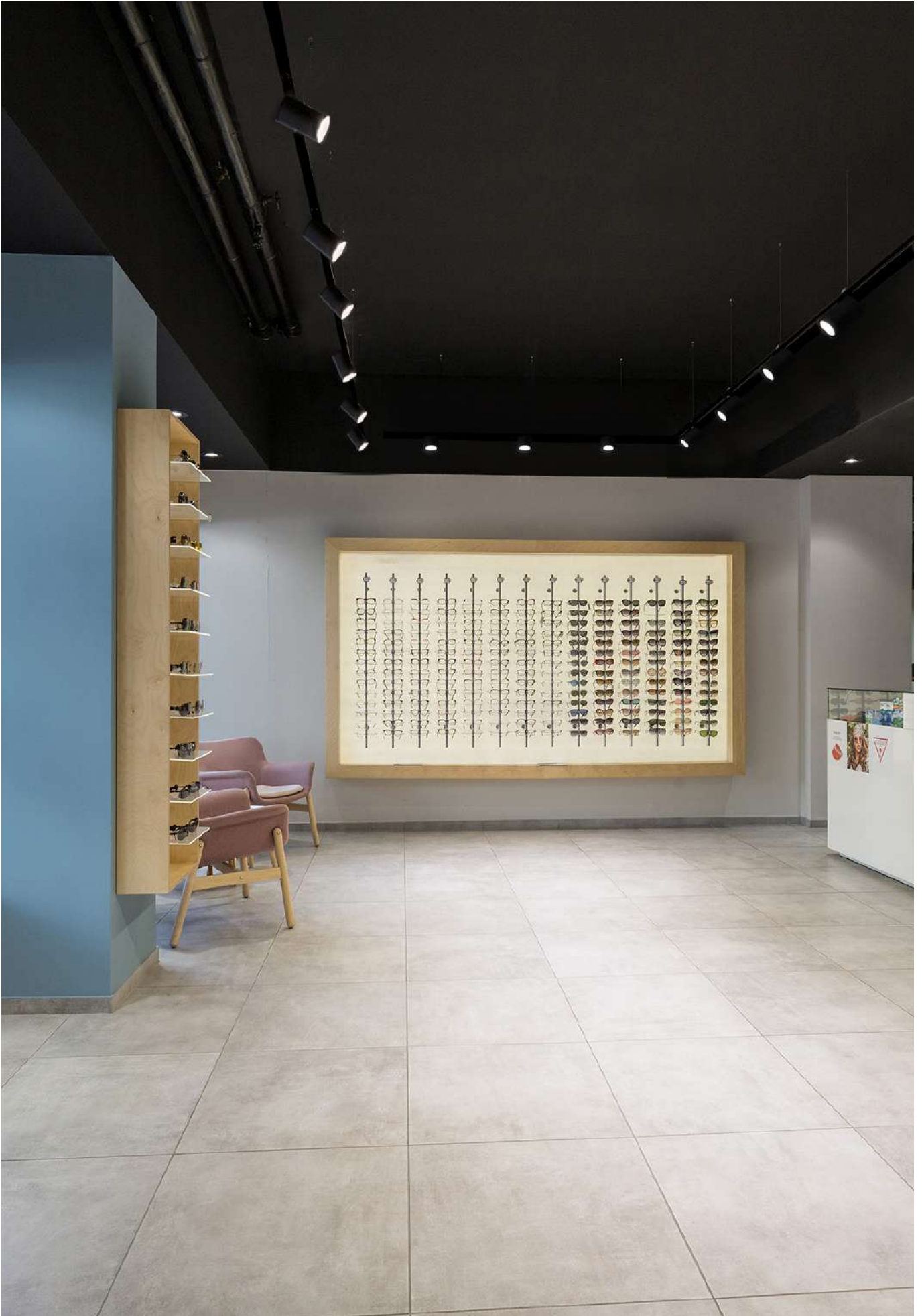

JACK 3 TP

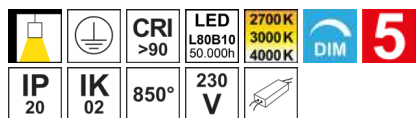

- Suspension décorative.
- Adaptateur pour Track III SURFACE.
- Livrée avec câble d'alimentation textile (réglable 1.60m max).
- Coloris 05 - 13 - 06 : câble noir.
- Coloris 30 - 28 - 02 : câble blanc.
- 2700K, 3000K ou 4000K au choix via un interrupteur à l'arrière du luminaire.
- Convertisseur dimmable intégré dans l'appareil.
- Compatible avec variateur fin de phase.
- Réserver une phase spécifique du rail pour les produits dimmables.



JACK 3 TP	COULEUR	MATIÈRE	P	CCT	LED LUMEN	SYSTEM LUMEN	α	€
TR42605	■ NOIR MAT	ALUMINIUM	25W	2700K 3000K 4000K	2810Lm (4000K)	2270Lm (4000K)	60°	207,00
TR42613	■ NOIR MAT - LAITON	ALUMINIUM	25W	2700K 3000K 4000K	2810Lm (4000K)	2270Lm (4000K)	60°	237,00
TR42606	■ NOIR MAT - OR ROSE	ALUMINIUM	25W	2700K 3000K 4000K	2810Lm (4000K)	2270Lm (4000K)	60°	237,00
TR42630	■ BLANC MAT	ALUMINIUM	25W	2700K 3000K 4000K	2810Lm (4000K)	2270Lm (4000K)	60°	207,00
TR42628	■ BLANC MAT - LAITON	ALUMINIUM	25W	2700K 3000K 4000K	2810Lm (4000K)	2270Lm (4000K)	60°	237,00
TR42602	■ BLANC MAT - OR ROSE	ALUMINIUM	25W	2700K 3000K 4000K	2810Lm (4000K)	2270Lm (4000K)	60°	237,00



DANS LA MÊME GAMME



JACK 3 P PAGE 230







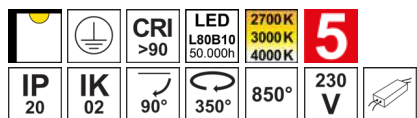





LIMA 1 PLUS



- Projecteur pour éclairage d'accentuation.
- Adaptateur pour Track III SURFACE.
- 2700K, 3000K ou 4000K au choix via un interrupteur à l'arrière du luminaire.
- Convertisseur non dimmable intégré dans l'appareil.
- Utiliser les verres pour alimentation avec la température de couleur 3000K.
- Base apparente TR241 à commander séparément.



LIMA 1 PLUS	COULEUR	MATIÈRE	P	CCT	LED LUMEN	SYSTEM LUMEN	α	€
TR39505	■ NOIR MAT	ALUMINIUM	25W	2700K 3000K 4000K	3000Lm (4000K)	2645Lm (4000K)	40°	153,00
TR39530	■ BLANC MAT	ALUMINIUM	25W	2700K 3000K 4000K	3000Lm (4000K)	2865Lm (4000K)	40°	153,00
TR39605	■ NOIR MAT	ALUMINIUM	25W	2700K 3000K 4000K	3000Lm (4000K)	2655Lm (4000K)	60°	153,00
TR39630	■ BLANC MAT	ALUMINIUM	25W	2700K 3000K 4000K	3000Lm (4000K)	2855Lm (4000K)	60°	153,00
ACCESSOIRES	COULEUR	DESCRIPTION					€	
TR32105	NOIR	GRILLE NID D'ABEILLE DIA.71MM						5,00
TR32432		VERRE ALIMENTATION DIA.71MM						28,00
TR32756		VERRE ALIMENTATION DIA.71MM						28,00
TR33058		FILTRE LAME DE LUMIERE DIA.71MM						4,00
TR38505	NOIR MAT	VOLET COUPE FLUX DIA.71MM						20,00
TR38530	BLANC MAT	VOLET COUPE FLUX DIA.71MM						20,00
TR24130	NOIR	BASE APPARENTE						30,00
TR24131	BLANC	BASE APPARENTE						30,00



NOIR MAT







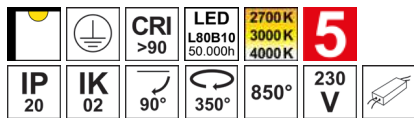

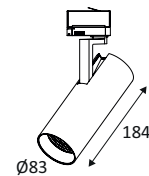

BLANC MAT

LIMA 2 PLUS



- Projecteur pour éclairage d'accentuation.
- Adaptateur pour Track III SURFACE.
- 2700K, 3000K ou 4000K au choix via un interrupteur à l'arrière du luminaire.
- Convertisseur non dimmable intégré dans l'appareil.
- Utiliser les verres pour alimentation avec la température de couleur 3000K.
- Base apparente TR241 à commander séparément.



LIMA 2 PLUS	COULEUR	MATIÈRE	P	CCT	LED LUMEN	SYSTEM LUMEN	α	€
TR39705	■ NOIR MAT	ALUMINIUM	35W	2700K 3000K 4000K	4500Lm (4000K)	3485Lm (4000K)	40°	173,00
TR39730	■ BLANC MAT	ALUMINIUM	35W	2700K 3000K 4000K	4500Lm (4000K)	4045Lm (4000K)	40°	173,00
TR39805	■ NOIR MAT	ALUMINIUM	35W	2700K 3000K 4000K	4500Lm (4000K)	3550Lm (4000K)	60°	173,00
TR39830	■ BLANC MAT	ALUMINIUM	35W	2700K 3000K 4000K	4500Lm (4000K)	4050Lm (4000K)	60°	173,00
ACCESSOIRES	COULEUR	DESCRIPTION						€
TR32205	NOIR	GRILLE NID D'ABEILLE DIA.83MM						6,00
TR32532		VERRE ALIMENTATION DIA.83MM						29,00
TR32856		VERRE ALIMENTATION DIA.83MM						29,00
TR33158		FILTRE LAME DE LUMIERE DIA.83MM						4,00
TR38605	NOIR MAT	VOLET COUPE FLUX DIA.83MM						22,00
TR38630	BLANC MAT	VOLET COUPE FLUX DIA.83MM						22,00
TR24130	NOIR	BASE APPARENTE						30,00
TR24131	BLANC	BASE APPARENTE						30,00



NOIR MAT



BLANC MAT





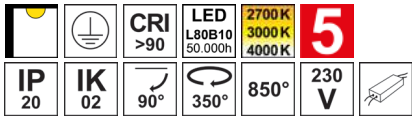



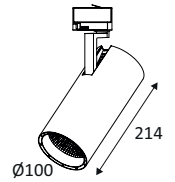

LIMA 3 PLUS



- Projecteur pour éclairage d'accentuation.
- Adaptateur pour Track III SURFACE.
- 2700K, 3000K ou 4000K au choix via un interrupteur à l'arrière du luminaire.
- Convertisseur non dimmable intégré dans l'appareil.
- Utiliser les verres pour alimentation avec la température de couleur 3000K.
- Base apparente TR241 à commander séparément.



LIMA 3 PLUS	COULEUR	MATIÈRE	P	CCT	LED LUMEN	SYSTEM LUMEN	α	€
TR39905	■ NOIR MAT	ALUMINIUM	50W	2700K 3000K 4000K	5600Lm (4000K)	4165Lm (4000K)	40°	213,00
TR39930	■ BLANC MAT	ALUMINIUM	50W	2700K 3000K 4000K	5600Lm (4000K)	4580Lm (4000K)	40°	213,00
TR40005	■ NOIR MAT	ALUMINIUM	50W	2700K 3000K 4000K	5600Lm (4000K)	4110Lm (4000K)	60°	213,00
TR40030	■ BLANC MAT	ALUMINIUM	50W	2700K 3000K 4000K	5600Lm (4000K)	4440Lm (4000K)	60°	213,00
ACCESSOIRES	COULEUR	DESCRIPTION					€	
TR32305	NOIR	GRILLE NID D'ABEILLE DIA.100MM					7,00	
TR32632		VERRE ALIMENTATION DIA.100MM					32,00	
TR32956		VERRE ALIMENTATION DIA.100MM					32,00	
TR33258		FILTRE LAME DE LUMIERE DIA.100MM					5,00	
TR38705	NOIR MAT	VOLET COUPE FLUX DIA.100MM					25,00	
TR38730	BLANC MAT	VOLET COUPE FLUX DIA.100MM					25,00	
TR24130	NOIR	BASE APPARENTE					30,00	
TR24131	BLANC	BASE APPARENTE					30,00	



NOIR MAT



BLANC MAT

LINEA 1

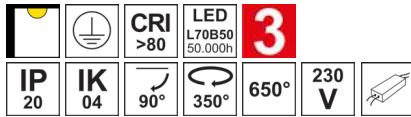

- Structure linéaire pour éclairage diffus.
- Adaptateur pour Track III SURFACE.
- Convertisseur non dimmable intégré dans l'appareil.
- Grille nid d'abeille en option.

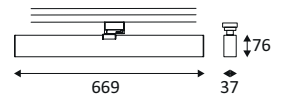

LINEA 1	COULEUR	MATIÈRE	P	CCT	L(MM)	LED LUMEN	SYSTEM LUMEN	α	€
TR357WW05	NOIR	ALUMINIUM	30W	3000K	669	3750Lm	3190Lm	120°	217,00
TR357WW30	BLANC	ALUMINIUM	30W	3000K	669	3750Lm	3190Lm	120°	217,00
TR357NW05	NOIR	ALUMINIUM	30W	4000K	669	3900Lm	3270Lm	120°	217,00
TR357NW30	BLANC	ALUMINIUM	30W	4000K	669	3900Lm	3270Lm	120°	217,00

ACCESSOIRES	COULEUR	DESCRIPTION	€
TR38805	NOIR	GRILLE NID D'ABEILLE 665X35MM	5,00



NOIR

BLANC

LINEA 2

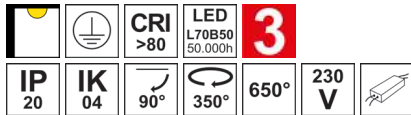

- Structure linéaire pour éclairage diffus.
- Adaptateur pour Track III SURFACE.
- Convertisseur non dimmable intégré dans l'appareil.
- Grilles nid d'abeille en option.



LINEA 2	COULEUR	MATIÈRE	P	CCT	L(MM)	LED LUMEN	SYSTEM LUMEN	α	€
TR358WW05	NOIR	ALUMINIUM	60W	3000K	669	2x3750Lm	6375Lm	120°	327,00
TR358WW30	BLANC	ALUMINIUM	60W	3000K	669	2x3750Lm	6375Lm	120°	327,00
TR358NW05	NOIR	ALUMINIUM	60W	4000K	669	2x3900Lm	6540Lm	120°	327,00
TR358NW30	BLANC	ALUMINIUM	60W	4000K	669	2x3900Lm	6540Lm	120°	327,00

ACCESSOIRES	COULEUR	DESCRIPTION	L(MM)	€
TR38805	NOIR	GRILLE NID D'ABEILLE 665X35MM	665	5,00



NOIR

BLANC



LINEA 1



LINEA 2

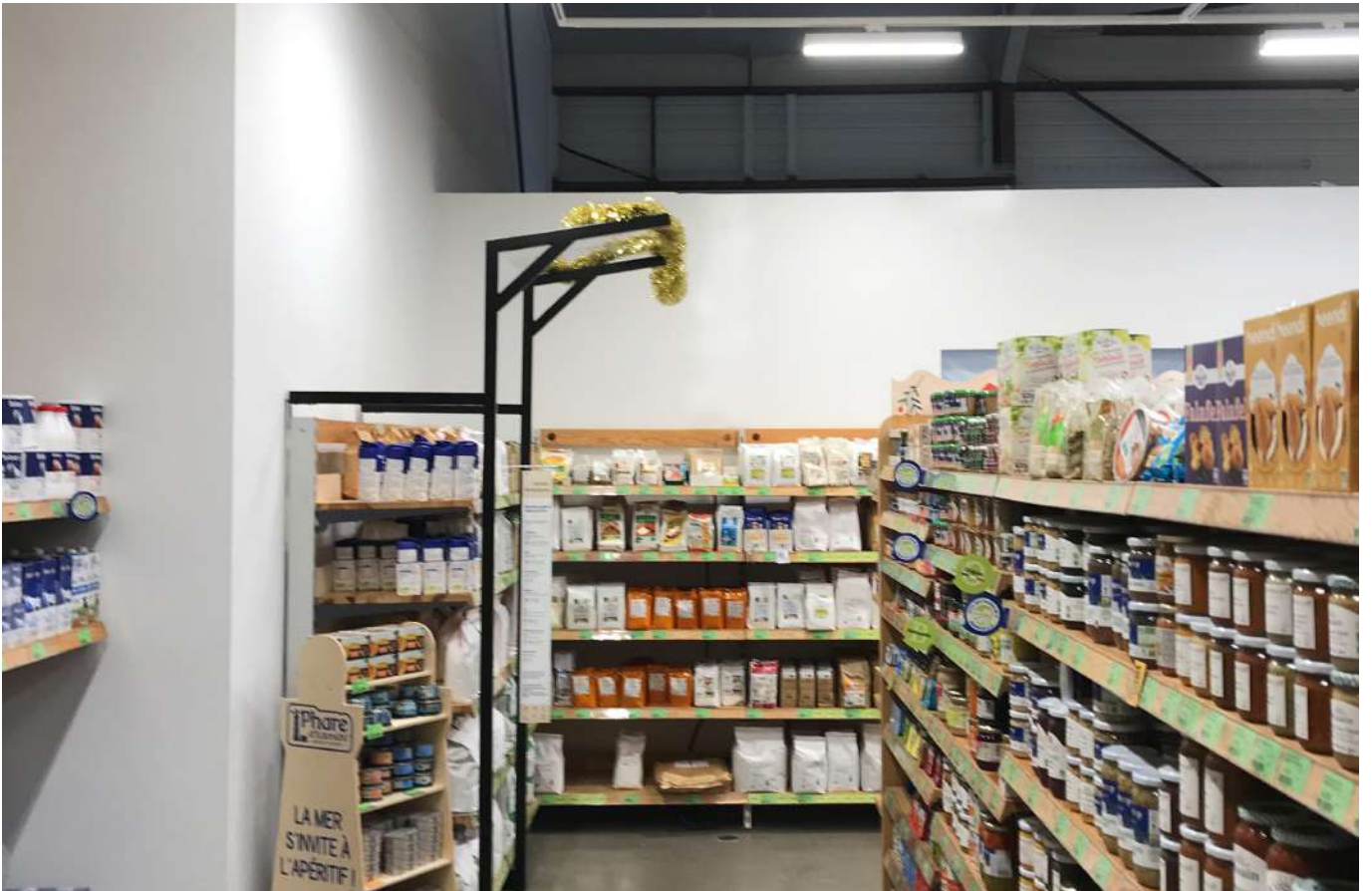

RAILS & PROJECTEURS

ARCHITECTURAL

DECO TRACK 48 M

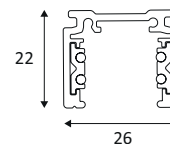

- Rail 48VDC pour montage en saillie.
- Hauteur de 22mm pour un design minimaliste.
- Convertisseur non-dimmable ou dimmable DALI-PUSH à commander séparément.

DECO TRACK 48 M	COULEUR	MATIÈRE	L(MM)	€
TR47105	■ NOIR MAT	ALUMINIUM	1000	62,00
TR47205	■ NOIR MAT	ALUMINIUM	2000	124,00
TR47305	■ NOIR MAT	ALUMINIUM	3000	185,00

ACCESSOIRES	COULEUR	MATIÈRE	DESCRIPTION	L(MM)	€
ALIMENTATIONS					

TR48005	NOIR MAT	PLASTIQUE	CONNECTEUR D'ALIMENTATION GAUCHE			41,00
---------	----------	-----------	----------------------------------	--	--	-------

TR48105	NOIR MAT	PLASTIQUE	CONNECTEUR D'ALIMENTATION DROIT			41,00
---------	----------	-----------	---------------------------------	--	--	-------

CONNECTEURS						
TR48605	NOIR MAT	PLASTIQUE	CONNECTEUR I + RENFORT MECANIQUE POUR RAILS M & L	144		41,00

TR48905	NOIR MAT	ALUMINIUM	PROFIL DE CONNEXION 90° GAUCHE PLAFOND POUR RAIL M			41,00
---------	----------	-----------	--	--	--	-------

TR49005	NOIR MAT	ALUMINIUM	PROFIL DE CONNEXION 90° DROIT PLAFOND POUR RAIL M			41,00
---------	----------	-----------	---	--	--	-------

TR48805	NOIR MAT	PLASTIQUE	CONNECTEUR L 90°			41,00
---------	----------	-----------	------------------	--	--	-------

TR49505	NOIR MAT	ALUMINIUM	PROFIL DE CONNEXION 90° MUR POUR RAIL M			41,00
---------	----------	-----------	---	--	--	-------

TR48505	NOIR MAT	PLASTIQUE	CONNECTEUR FLEXIBLE			41,00
---------	----------	-----------	---------------------	--	--	-------

CONVERTISSEURS					
5742			CONVERTISSEUR TENSION CONSTANTE 150W 48VDC		60,00

CD190			CONVERTISSEUR TENSION CONSTANTE 100W 48V		70,00
-------	--	--	--	--	-------



5744			CONVERTISSEUR TENSION CONSTANTE 250W 48VDC		115,00
------	--	--	--	--	--------

5997			CONVERTISSEUR TENSION CONSTANTE 320W 48VDC		350,00
------	--	--	--	--	--------

CONVERTISSEURS DIMMABLES						
CD184		ALUMINIUM	CONVERTISSEUR 200W 48V DALI-PUSH	369		309,00

CD185		ALUMINIUM	CONVERTISSEUR 100W 48V DALI-PUSH	355		206,00
-------	--	-----------	----------------------------------	-----	--	--------



ACCESSOIRES	COULEUR	MATIÈRE	DESCRIPTION	L(MM)	€
ACCESSOIRES DE FIXATION					
TR49905	NOIR MAT	PLASTIQUE	SUPPORT DE FIXATION POUR RAILS M & L	11:  28 30	5,00
TR49805	NOIR MAT	PLASTIQUE	KIT DE SUSPENSION 300CM POUR RAILS M & L	62	21,00
TR50305	NOIR MAT	INOX	PIECE DE RENFORT + SUSPENSION 300CM POUR RAILS M & L	120	41,00
EMBOUS					
TR48205	NOIR MAT	PLASTIQUE	EMBOUT DE FINITION POUR RAIL M	22:  26 22	5,00

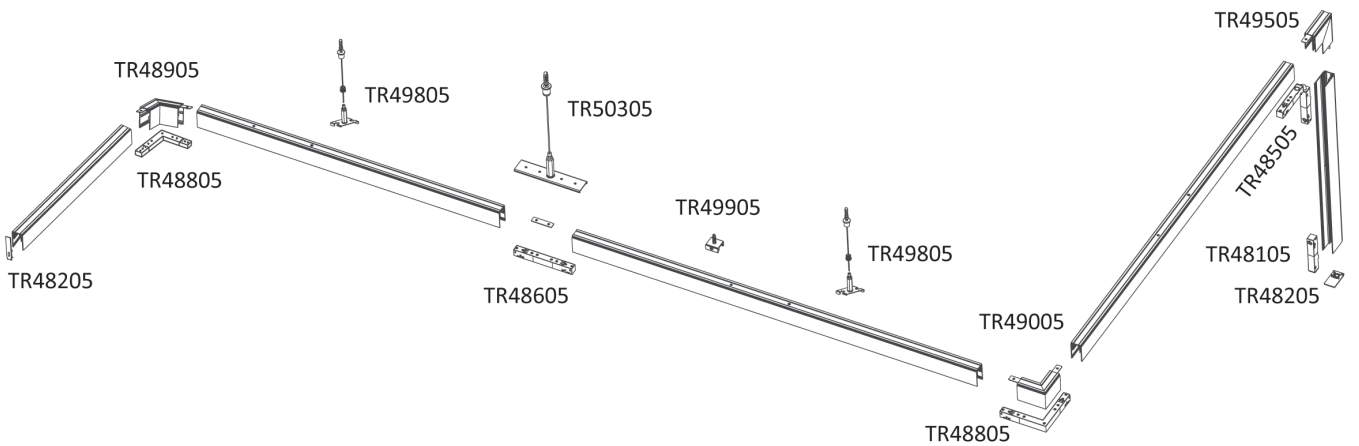

DECO TRACK 48 L

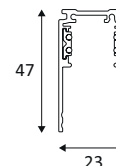
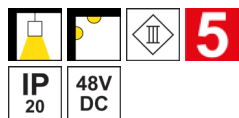

- Rail 48VDC pour montage en saillie.
- Hauteur de 47mm permettant l'intégration complète des modules linéaires et des convertisseurs avec adaptateur pour DECO TRACK 48 pour un design élégant et épuré.
- Convertisseur non-dimmable ou dimmable DALI-PUSH à commander séparément.

DECO TRACK 48 L	COULEUR	MATIÈRE	L(MM)	€
TR47705	■ NOIR MAT	ALUMINIUM	1000	82,00
TR47805	■ NOIR MAT	ALUMINIUM	2000	164,00
TR47905	■ NOIR MAT	ALUMINIUM	3000	247,00

ACCESSOIRES	COULEUR	MATIÈRE	DESCRIPTION	L(MM)	€
ALIMENTATIONS					

TR48005	NOIR MAT	PLASTIQUE	CONNECTEUR D'ALIMENTATION GAUCHE			41,00
---------	----------	-----------	----------------------------------	--	--	-------

TR48105	NOIR MAT	PLASTIQUE	CONNECTEUR D'ALIMENTATION DROIT			41,00
---------	----------	-----------	---------------------------------	--	--	-------

CONNECTEURS					
--------------------	--	--	--	--	--

TR48605	NOIR MAT	PLASTIQUE	CONNECTEUR I + RENFORT MECANIQUE POUR RAILS M & L	144		41,00
---------	----------	-----------	---	-----	--	-------

TR49305	NOIR MAT	ALUMINIUM	PROFIL DE CONNEXION 90° GAUCHE PLAFOND POUR RAIL L			41,00
---------	----------	-----------	--	--	--	-------

TR49405	NOIR MAT	ALUMINIUM	PROFIL DE CONNEXION 90° DROIT PLAFOND POUR RAIL L			41,00
---------	----------	-----------	---	--	--	-------

TR48805	NOIR MAT	PLASTIQUE	CONNECTEUR L 90°			41,00
---------	----------	-----------	------------------	--	--	-------

TR49705	NOIR MAT	ALUMINIUM	PROFIL DE CONNEXION 90° MUR POUR RAIL L			41,00
---------	----------	-----------	---	--	--	-------

TR48505	NOIR MAT	PLASTIQUE	CONNECTEUR FLEXIBLE			41,00
---------	----------	-----------	---------------------	--	--	-------

CONVERTISSEURS					
-----------------------	--	--	--	--	--

5742			CONVERTISSEUR TENSION CONSTANTE 150W 48VDC			60,00
------	--	--	--	--	--	-------

5744			CONVERTISSEUR TENSION CONSTANTE 250W 48VDC.			115,00
------	--	--	---	--	--	--------

CD182	NOIR MAT	COMPOSITE	CONVERTISSEUR IN-TRACK 100W 48V	268		155,00
-------	----------	-----------	---------------------------------	-----	--	--------

CD183	NOIR MAT	COMPOSITE	CONVERTISSEUR IN-TRACK 250W 48V	268		206,00
-------	----------	-----------	---------------------------------	-----	--	--------

5997			CONVERTISSEUR TENSION CONSTANTE 320W 48VDC			350,00
------	--	--	--	--	--	--------

CONVERTISSEURS DIMMABLES					
---------------------------------	--	--	--	--	--

CD184		ALUMINIUM	CONVERTISSEUR 200W 48V DALI-PUSH	369		309,00
-------	--	-----------	----------------------------------	-----	--	--------

CD185		ALUMINIUM	CONVERTISSEUR 100W 48V DALI-PUSH	355		206,00
-------	--	-----------	----------------------------------	-----	--	--------



ACCESSOIRES	COULEUR	MATIÈRE	DESCRIPTION	L(MM)		€
ACCESSOIRES DE FIXATION						
TR49905	NOIR MAT	PLASTIQUE	SUPPORT DE FIXATION POUR RAILS M & L	111		5,00
TR49805	NOIR MAT	PLASTIQUE	KIT DE SUSPENSION 300CM POUR RAILS M & L	62		21,00
TR50305	NOIR MAT	INOX	PIECE DE RENFORT + SUSPENSION 300CM POUR RAILS M & L	120		41,00
MOULURES						
TR50005	NOIR MAT	PLASTIQUE	MOULURE DE FINITION 100CM POUR RAILS S & L	1000		8,25
TR50105	NOIR MAT	PLASTIQUE	MOULURE DE FINITION 200CM POUR RAILS S & L	2000		16,50
TR50205	NOIR MAT	PLASTIQUE	MOULURE DE FINITION 300CM POUR RAILS S & L	3000		25,75
EMBOUTS						
TR48405	NOIR MAT	PLASTIQUE	EMBOUT DE FINITION POUR RAIL L	47		5,00

TR47705 TR47805 TR47905	TR48005 TR48105	TR48605	TR48805	TR48505	TR48405	TR49305 TR49405	TR49705	TR49805	TR50305	TR49905	

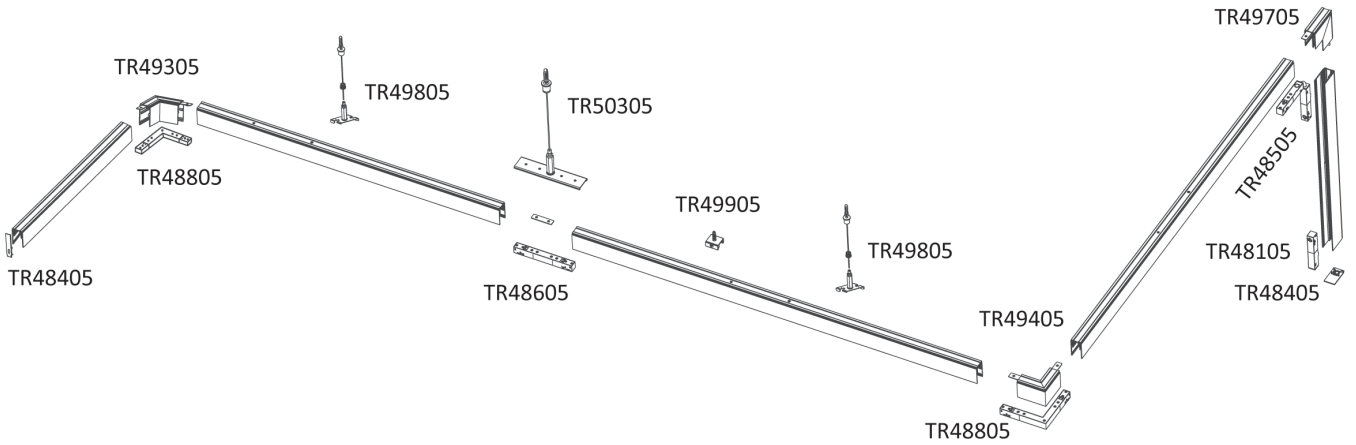

DECO TRACK 48 S

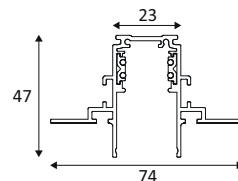
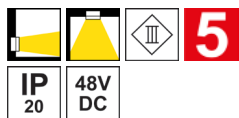

- Rail 48VDC pour montage encastré.
- Intégration complète des modules linéaires et des convertisseurs avec adaptateur pour DECO TRACK 48 pour un design élégant et épuré.
- Convertisseur non-dimmable ou dimmable DALI-PUSH à commander séparément.

DECO TRACK 48 S	COULEUR	MATIÈRE	L(MM)	€
TR47405	■ NOIR MAT	ALUMINIUM	1000	92,00
TR47505	■ NOIR MAT	ALUMINIUM	2000	185,00
TR47605	■ NOIR MAT	ALUMINIUM	3000	278,00

ACCESSOIRES	COULEUR	MATIÈRE	DESCRIPTION	L(MM)	€
ALIMENTATIONS					

TR48005	NOIR MAT	PLASTIQUE	CONNECTEUR D'ALIMENTATION GAUCHE		41,00
---------	----------	-----------	----------------------------------	--	-------

TR48105	NOIR MAT	PLASTIQUE	CONNECTEUR D'ALIMENTATION DROIT		41,00
---------	----------	-----------	---------------------------------	--	-------

CONNECTEURS					
TR48705	NOIR MAT	PLASTIQUE	CONNECTEUR I + RENFORTS MECANIQUE POUR RAIL S	144	41,00

TR49105	NOIR MAT	ALUMINIUM	PROFIL DE CONNEXION 90° GAUCHE PLAFOND POUR RAIL S		41,00
---------	----------	-----------	--	--	-------

TR49205	NOIR MAT	ALUMINIUM	PROFIL DE CONNEXION 90° DROIT PLAFOND POUR RAIL S		41,00
---------	----------	-----------	---	--	-------

TR48805	NOIR MAT	PLASTIQUE	CONNECTEUR L 90°		41,00
---------	----------	-----------	------------------	--	-------

TR49605	NOIR MAT	ALUMINIUM	PROFIL DE CONNEXION 90° MUR POUR RAIL S	113	41,00
---------	----------	-----------	---	-----	-------

TR48505	NOIR MAT	PLASTIQUE	CONNECTEUR FLEXIBLE		41,00
---------	----------	-----------	---------------------	--	-------

CONVERTISSEURS					
5742			CONVERTISSEUR TENSION CONSTANTE 150W 48VDC		60,00

5744			CONVERTISSEUR TENSION CONSTANTE 250W 48VDC.		115,00
------	--	--	---	--	--------

CD182	NOIR MAT	COMPOSITE	CONVERTISSEUR IN-TRACK 100W 48V	268	155,00
-------	----------	-----------	---------------------------------	-----	--------





CD183	NOIR MAT	COMPOSITE	CONVERTISSEUR IN-TRACK 250W 48V	268	206,00
-------	----------	-----------	---------------------------------	-----	--------

5997			CONVERTISSEUR TENSION CONSTANTE 320W 48VDC		350,00
------	--	--	--	--	--------

CONVERTISSEURS DIMMABLES					
CD184		ALUMINIUM	CONVERTISSEUR 200W 48V DALI-PUSH	369	309,00

CD185		ALUMINIUM	CONVERTISSEUR 100W 48V DALI-PUSH	355	206,00
-------	--	-----------	----------------------------------	-----	--------



ACCESSOIRES	COULEUR	MATIÈRE	DESCRIPTION	L(MM)		€
TR50005	NOIR MAT	PLASTIQUE	MOULURE DE FINITION 100CM POUR RAILS S & L	1000		8,25
TR50105	NOIR MAT	PLASTIQUE	MOULURE DE FINITION 200CM POUR RAILS S & L	2000		16,50
TR50205	NOIR MAT	PLASTIQUE	MOULURE DE FINITION 300CM POUR RAILS S & L	3000		25,75
EMBOUTS						
TR48305	NOIR MAT	PLASTIQUE	EMBOUT DE FINITION POUR RAIL S		 47 34	5,00

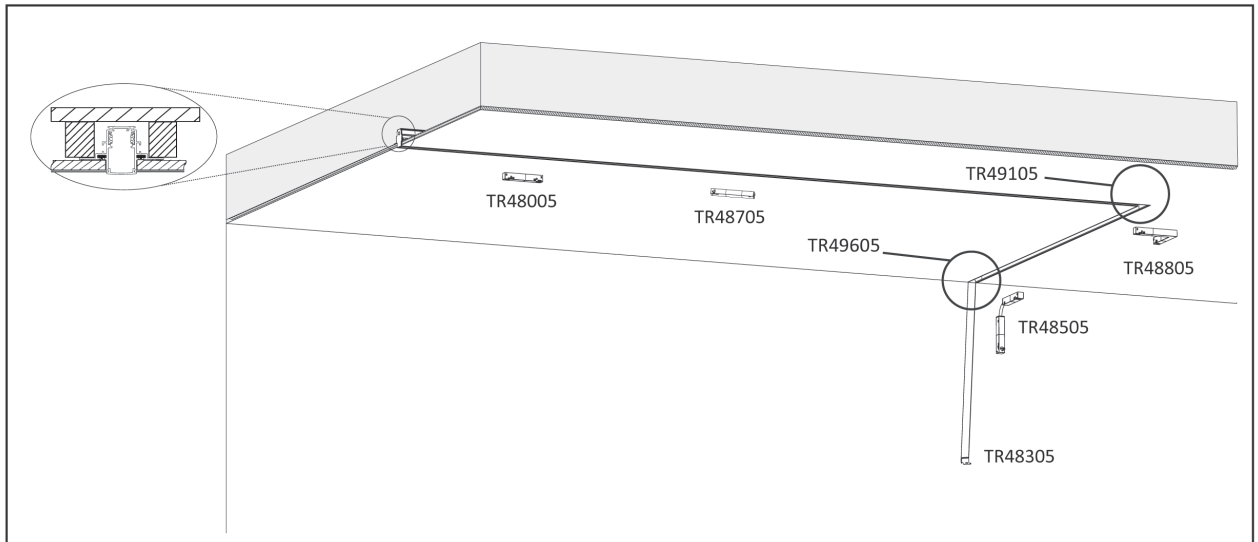
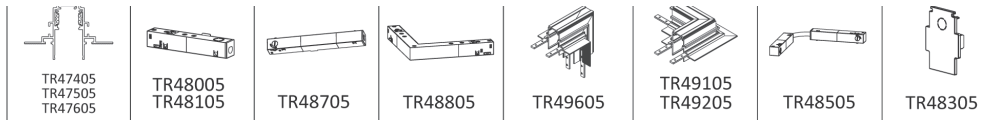

TORO T

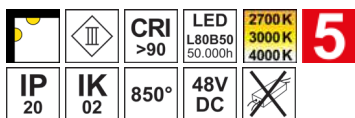

- Module décoratif pour DECO TRACK 48.
- 2700K, 3000K ou 4000K au choix via un interrupteur sur l'adaptateur.
- Dimmable avec un convertisseur DALI-PUSH (CD184, CD185).



TORO T	COULEUR	MATIÈRE	P	CCT	LED LUMEN	SYSTEM LUMEN	α	€
TR46905	■ NOIR MAT	VERRE	5W	2700K 3000K 4000K	400Lm (4000K)	385Lm (4000K)	230°	113,00

TORO TP

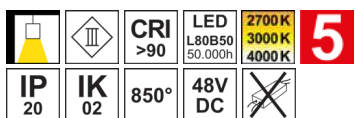

- Suspension décorative pour DECO TRACK 48.
- Câble de suspension réglable de 1m50.
- 2700K, 3000K ou 4000K au choix via un interrupteur sur l'adaptateur.
- Dimmable avec un convertisseur DALI-PUSH (CD184, CD185).



TORO TP	COULEUR	MATIÈRE	P	CCT	LED LUMEN	SYSTEM LUMEN	α	€
TR47005	■ NOIR MAT	VERRE	5W	2700K 3000K 4000K	400Lm (4000K)	385Lm (4000K)	230°	133,00



SANDO T

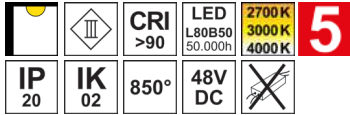

- Module décoratif pour DECO TRACK 48.
- 2700K, 3000K ou 4000K au choix via un interrupteur sur l'adaptateur.
- Dimmable avec un convertisseur DALI-PUSH (CD184, CD185).

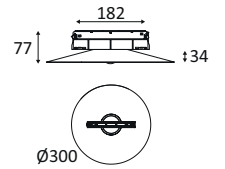

SANDO T	COULEUR	MATIÈRE	P	CCT	LED LUMEN	SYSTEM LUMEN	α	€
TR45605	■ NOIR MAT	ALUMINIUM	7W	2700K 3000K 4000K	850Lm (4000K)	615Lm (4000K)	36°	165,00

SANDO TP

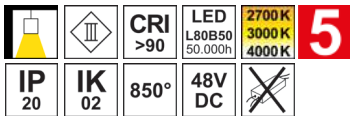

- Suspension décorative pour DECO TRACK 48.
- Câble de suspension réglable de 1m50.
- 2700K, 3000K ou 4000K au choix via un interrupteur sur l'adaptateur.
- Dimmable avec un convertisseur DALI-PUSH (CD184, CD185).

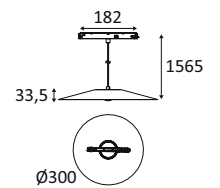

SANDO TP	COULEUR	MATIÈRE	P	CCT	LED LUMEN	SYSTEM LUMEN	α	€
TR45705	■ NOIR MAT	ALUMINIUM	7W	2700K 3000K 4000K	850Lm (4000K)	615Lm (4000K)	36°	175,00

DALMA T

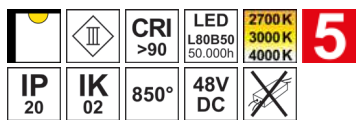

- Module décoratif à éclairage indirect pour DECO TRACK 48.
- 2700K, 3000K ou 4000K au choix via un interrupteur sur l'adaptateur.
- Dimmable avec un convertisseur DALI-PUSH (CD184, CD185).

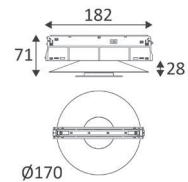

DALMA T	COULEUR	MATIÈRE	P	CCT	LED LUMEN	SYSTEM LUMEN	α	€
TR45805	■ NOIR MAT	ALUMINIUM	7W	2700K 3000K 4000K	1000Lm (4000K)	245Lm (4000K)	155°	155,00





TONKA

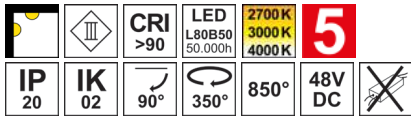

- Projecteur pour éclairage d'accentuation pour DECO TRACK 48.
- 2700K, 3000K ou 4000K au choix via un interrupteur sur l'adaptateur.
- Dimmable avec un convertisseur DALI-PUSH (CD184, CD185).

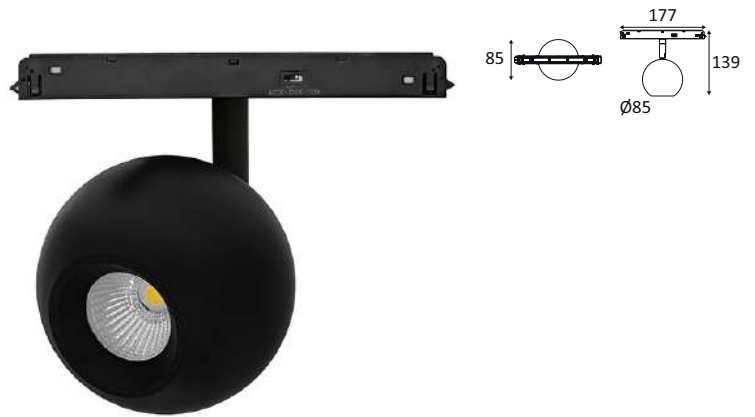

TONKA	COULEUR	MATIÈRE	P	CCT	LED LUMEN	SYSTEM LUMEN	α	€
TR46805	■ NOIR MAT	ALUMINIUM	7W	2700K 3000K 4000K	1050Lm (4000K)	630Lm (4000K)	38°	155,00



DISU 1

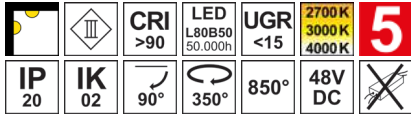

- Projecteur pour éclairage d'accentuation pour DECO TRACK 48.
- 2700K, 3000K ou 4000K au choix via un interrupteur sur l'adaptateur.
- Dimmable avec un convertisseur DALI-PUSH (CD184, CD185).

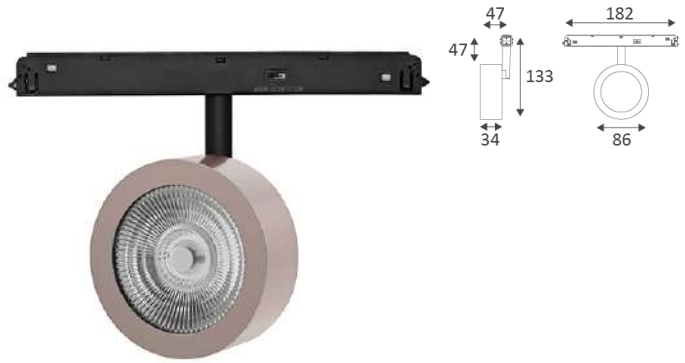

DISU 1	COULEUR	MATIÈRE	P	CCT	LED LUMEN	SYSTEM LUMEN	α	€
TR45205	■ NOIR MAT	ALUMINIUM	7W	2700K 3000K 4000K	1100Lm (4000K)	665Lm (4000K)	40°	124,00
TR45235	▣ NOIR MAT - BLANC MAT	ALUMINIUM	7W	2700K 3000K 4000K	1100Lm (4000K)	665Lm (4000K)	40°	129,00
TR45208	▣ NOIR MAT - DORÉ	ALUMINIUM	7W	2700K 3000K 4000K	1100Lm (4000K)	665Lm (4000K)	40°	129,00
TR45206	▣ NOIR MAT - OR ROSE	ALUMINIUM	7W	2700K 3000K 4000K	1100Lm (4000K)	665Lm (4000K)	40°	129,00



NOIR MAT

NOIR MAT - BLANC MAT

NOIR MAT - DORÉ

NOIR MAT - OR ROSE





DISU 2

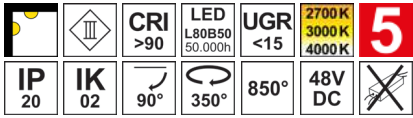

- Projecteur pour éclairage d'accentuation pour DECO TRACK 48.
- 2700K, 3000K ou 4000K au choix via un interrupteur sur l'adaptateur.
- Dimmable avec un convertisseur DALI-PUSH (CD184, CD185).

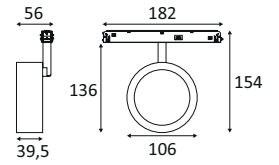

DISU 2	COULEUR	MATIÈRE	P	CCT	LED LUMEN	SYSTEM LUMEN	α	€
TR45305	■ NOIR MAT	ALUMINIUM	15W	2700K 3000K 4000K	2100Lm (4000K)	1595Lm (4000K)	36°	144,00
TR45335	▬ NOIR MAT - BLANC MAT	ALUMINIUM	15W	2700K 3000K 4000K	2100Lm (4000K)	1595Lm (4000K)	36°	149,00
TR45308	▬ NOIR MAT - DORÉ	ALUMINIUM	15W	2700K 3000K 4000K	2100Lm (4000K)	1595Lm (4000K)	36°	149,00
TR45306	▬ NOIR MAT - OR ROSE	ALUMINIUM	15W	2700K 3000K 4000K	2100Lm (4000K)	1595Lm (4000K)	36°	149,00



ZUMU

		CRI >90	LED L80B50 50.000h	2700K 3000K 4000K	5
IP 20	IK 02	90°	350°	850°	48V DC

- Projecteur pour éclairage d'accentuation pour DECO TRACK 48.
- Faisceau ajustable de 25° à 75°.
- 2700K, 3000K ou 4000K au choix via un interrupteur sur l'adaptateur.
- Dimmable avec un convertisseur DALI-PUSH (CD184, CD185).



ZUMU	COULEUR	MATIÈRE	P	CCT	LED LUMEN	SYSTEM LUMEN	α	€
TR46705	NOIR MAT	ALUMINIUM	15W	2700K 3000K 4000K	1950Lm (4000K)	1405Lm (4000K)	25-75°	205,00





YOKO 1

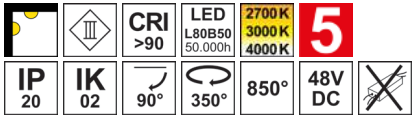

- Projecteur pour éclairage d'accentuation pour DECO TRACK 48.
- Cylindre lisse.
- 2700K, 3000K ou 4000K au choix via un interrupteur sur l'adaptateur.
- Dimmable avec un convertisseur DALI-PUSH (CD184, CD185).

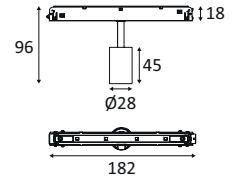

YOKO 1	COULEUR	MATIÈRE	P	CCT	LED LUMEN	SYSTEM LUMEN	α	€
TR45905	■ NOIR MAT	ALUMINIUM	4W	2700K 3000K 4000K	300Lm (4000K)	215Lm (4000K)	30°	93,00
TR45935	▬ NOIR MAT - BLANC MAT	ALUMINIUM	4W	2700K 3000K 4000K	300Lm (4000K)	215Lm (4000K)	30°	98,00
TR45908	▬ NOIR MAT - DORÉ	ALUMINIUM	4W	2700K 3000K 4000K	300Lm (4000K)	215Lm (4000K)	30°	98,00
TR45906	▬ NOIR MAT - OR ROSE	ALUMINIUM	4W	2700K 3000K 4000K	300Lm (4000K)	215Lm (4000K)	30°	98,00



NOIR MAT NOIR MAT - BLANC MAT NOIR MAT - DORÉ NOIR MAT - OR ROSE

YOKA 1

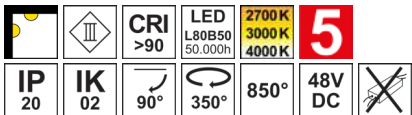

- Projecteur pour éclairage d'accentuation pour DECO TRACK 48.
- Cylindre texturé.
- 2700K, 3000K ou 4000K au choix via un interrupteur sur l'adaptateur.
- Dimmable avec un convertisseur DALI-PUSH (CD184, CD185).

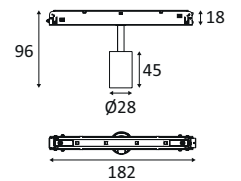

YOKA 1	COULEUR	MATIÈRE	P	CCT	LED LUMEN	SYSTEM LUMEN	α	€
TR46305	■ NOIR MAT	ALUMINIUM	4W	2700K 3000K 4000K	300Lm (4000K)	215Lm (4000K)	30°	103,00
TR46335	▬ NOIR MAT - BLANC MAT	ALUMINIUM	4W	2700K 3000K 4000K	300Lm (4000K)	215Lm (4000K)	30°	108,00
TR46308	▬ NOIR MAT - DORÉ	ALUMINIUM	4W	2700K 3000K 4000K	300Lm (4000K)	215Lm (4000K)	30°	108,00
TR46306	▬ NOIR MAT - OR ROSE	ALUMINIUM	4W	2700K 3000K 4000K	300Lm (4000K)	215Lm (4000K)	30°	108,00



NOIR MAT NOIR MAT - BLANC MAT NOIR MAT - DORÉ NOIR MAT - OR ROSE

YOKO 2

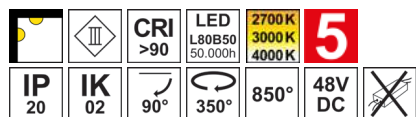

- Projecteur pour éclairage d'accentuation pour DECO TRACK 48.
- Cylindre lisse.
- 2700K, 3000K ou 4000K au choix via un interrupteur sur l'adaptateur.
- Dimmable avec un convertisseur DALI-PUSH (CD184, CD185).

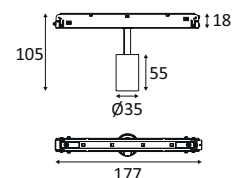

YOKO 2	COULEUR	MATIÈRE	P	CCT	LED LUMEN	SYSTEM LUMEN	α	€
TR46005	■ NOIR MAT	ALUMINIUM	7W	2700K 3000K 4000K	1050Lm (4000K)	620Lm (4000K)	40°	103,00
TR46035	▴ NOIR MAT - BLANC MAT	ALUMINIUM	7W	2700K 3000K 4000K	1050Lm (4000K)	620Lm (4000K)	40°	108,00
TR46008	▣ NOIR MAT - DORÉ	ALUMINIUM	7W	2700K 3000K 4000K	1050Lm (4000K)	620Lm (4000K)	40°	108,00
TR46006	▢ NOIR MAT - OR ROSE	ALUMINIUM	7W	2700K 3000K 4000K	1050Lm (4000K)	620Lm (4000K)	40°	108,00



YOKA 2

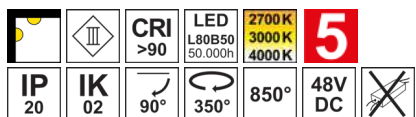

- Projecteur pour éclairage d'accentuation pour DECO TRACK 48.
- Cylindre texturé.
- 2700K, 3000K ou 4000K au choix via un interrupteur sur l'adaptateur.
- Dimmable avec un convertisseur DALI-PUSH (CD184, CD185).

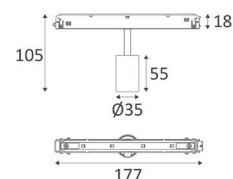

YOKA 2	COULEUR	MATIÈRE	P	CCT	LED LUMEN	SYSTEM LUMEN	α	€
TR46405	■ NOIR MAT	ALUMINIUM	7W	2700K 3000K 4000K	1050Lm (4000K)	620Lm (4000K)	40°	113,00
TR46435	▴ NOIR MAT - BLANC MAT	ALUMINIUM	7W	2700K 3000K 4000K	1050Lm (4000K)	620Lm (4000K)	40°	118,00
TR46408	▣ NOIR MAT - DORÉ	ALUMINIUM	7W	2700K 3000K 4000K	1050Lm (4000K)	620Lm (4000K)	40°	118,00
TR46406	▢ NOIR MAT - OR ROSE	ALUMINIUM	7W	2700K 3000K 4000K	1050Lm (4000K)	620Lm (4000K)	40°	118,00





YOKO 3

- Projecteur pour éclairage d'accentuation pour DECO TRACK 48.
- Cylindre lisse.
- 2700K, 3000K ou 4000K au choix via un interrupteur sur l'adaptateur.
- Dimmable avec un convertisseur DALI-PUSH (CD184, CD185).

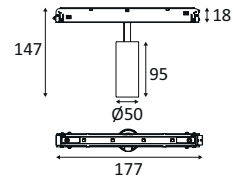

YOKO 3	COULEUR	MATIÈRE	P	CCT	LED LUMEN	SYSTEM LUMEN	α	€
TR46105	NOIR MAT	ALUMINIUM	15W	2700K 3000K 4000K	1950Lm (4000K)	1315Lm (4000K)	40°	154,00
TR46135	NOIR MAT - BLANC MAT	ALUMINIUM	15W	2700K 3000K 4000K	1950Lm (4000K)	1315Lm (4000K)	40°	159,00
TR46108	NOIR MAT - DORÉ	ALUMINIUM	15W	2700K 3000K 4000K	1950Lm (4000K)	1315Lm (4000K)	40°	159,00
TR46106	NOIR MAT - OR ROSE	ALUMINIUM	15W	2700K 3000K 4000K	1950Lm (4000K)	1315Lm (4000K)	40°	159,00



YOKA 3

- Projecteur pour éclairage d'accentuation pour DECO TRACK 48.
- Cylindre texturé.
- 2700K, 3000K ou 4000K au choix via un interrupteur sur l'adaptateur.
- Dimmable avec un convertisseur DALI-PUSH (CD184, CD185).

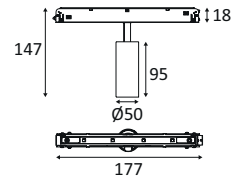

YOKA 3	COULEUR	MATIÈRE	P	CCT	LED LUMEN	SYSTEM LUMEN	α	€
TR46505	NOIR MAT	ALUMINIUM	15W	2700K 3000K 4000K	1950Lm (4000K)	1315Lm (4000K)	40°	165,00
TR46535	NOIR MAT - BLANC MAT	ALUMINIUM	15W	2700K 3000K 4000K	1950Lm (4000K)	1315Lm (4000K)	40°	170,00
TR46508	NOIR MAT - DORÉ	ALUMINIUM	15W	2700K 3000K 4000K	1950Lm (4000K)	1315Lm (4000K)	40°	170,00
TR46506	NOIR MAT - OR ROSE	ALUMINIUM	15W	2700K 3000K 4000K	1950Lm (4000K)	1315Lm (4000K)	40°	170,00



YOKO 4

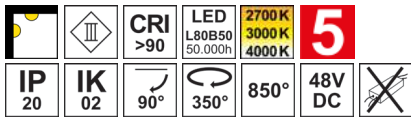

- Projecteur pour éclairage d'accentuation pour DECO TRACK 48.
- Cylindre lisse.
- 2700K, 3000K ou 4000K au choix via un interrupteur sur l'adaptateur.
- Dimmable avec un convertisseur DALI-PUSH (CD184, CD185).

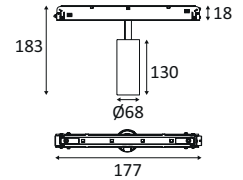

YOKO 4	COULEUR	MATIÈRE	P	CCT	LED LUMEN	SYSTEM LUMEN	α	€
TR46205	■ NOIR MAT	ALUMINIUM	27W	2700K 3000K 4000K	3400Lm (4000K)	2675Lm (4000K)	40°	205,00
TR46235	▨ NOIR MAT - BLANC MAT	ALUMINIUM	27W	2700K 3000K 4000K	3400Lm (4000K)	2675Lm (4000K)	40°	210,00
TR46208	▩ NOIR MAT - DORÉ	ALUMINIUM	27W	2700K 3000K 4000K	3400Lm (4000K)	2675Lm (4000K)	40°	210,00
TR46206	▪ NOIR MAT - OR ROSE	ALUMINIUM	27W	2700K 3000K 4000K	3400Lm (4000K)	2675Lm (4000K)	40°	210,00



YOKA 4

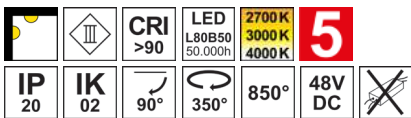

- Projecteur pour éclairage d'accentuation pour DECO TRACK 48.
- Cylindre texturé.
- 2700K, 3000K ou 4000K au choix via un interrupteur sur l'adaptateur.
- Dimmable avec un convertisseur DALI-PUSH (CD184, CD185).

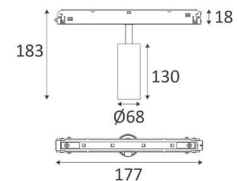

YOKA 4	COULEUR	MATIÈRE	P	CCT	LED LUMEN	SYSTEM LUMEN	α	€
TR46605	■ NOIR MAT	ALUMINIUM	27W	2700K 3000K 4000K	3400Lm (4000K)	2675Lm (4000K)	40°	215,00
TR46635	▨ NOIR MAT - BLANC MAT	ALUMINIUM	27W	2700K 3000K 4000K	3400Lm (4000K)	2675Lm (4000K)	40°	220,00
TR46608	▩ NOIR MAT - DORÉ	ALUMINIUM	27W	2700K 3000K 4000K	3400Lm (4000K)	2675Lm (4000K)	40°	220,00
TR46606	▪ NOIR MAT - OR ROSE	ALUMINIUM	27W	2700K 3000K 4000K	3400Lm (4000K)	2675Lm (4000K)	40°	220,00





TOMO

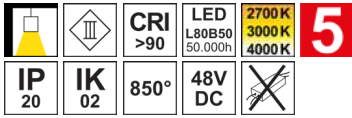

- Suspension pour DECO TRACK 48.
- Cylindre lisse.
- Câble de suspension réglable de 1m50.
- 2700K, 3000K ou 4000K au choix via un interrupteur sur l'adaptateur.
- Dimmable avec un convertisseur DALI-PUSH (CD184, CD185).

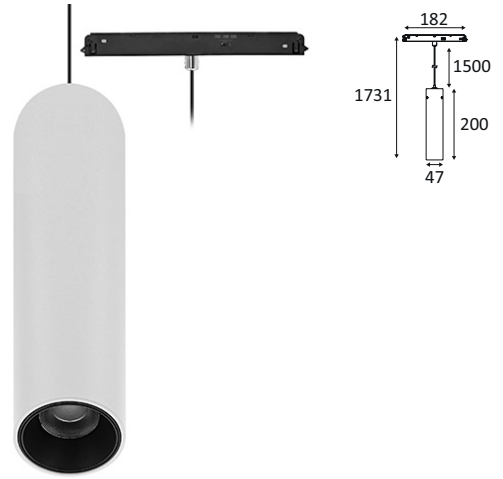

TOMO	COULEUR	MATIÈRE	P	CCT	LED LUMEN	SYSTEM LUMEN	α	€
TR45405	■ NOIR MAT	ALUMINIUM	20W	2700K 3000K 4000K	2300Lm (4000K)	1450Lm (4000K)	40°	155,00
TR45435	▬ NOIR MAT - BLANC MAT	ALUMINIUM	20W	2700K 3000K 4000K	2300Lm (4000K)	1450Lm (4000K)	40°	160,00
TR45408	▬ NOIR MAT - DORÉ	ALUMINIUM	20W	2700K 3000K 4000K	2300Lm (4000K)	1450Lm (4000K)	40°	160,00
TR45406	▬ NOIR MAT - OR ROSE	ALUMINIUM	20W	2700K 3000K 4000K	2300Lm (4000K)	1450Lm (4000K)	40°	160,00



TOMA

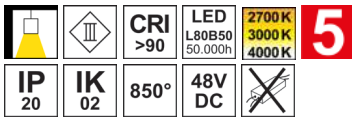

- Suspension pour DECO TRACK 48.
- Cylindre texturé.
- Câble de suspension réglable de 1m50.
- 2700K, 3000K ou 4000K au choix via un interrupteur sur l'adaptateur.
- Dimmable avec un convertisseur DALI-PUSH (CD184, CD185).

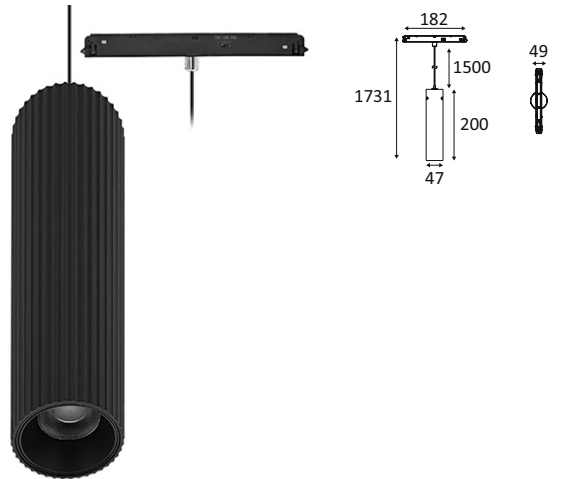

TOMA	COULEUR	MATIÈRE	P	CCT	LED LUMEN	SYSTEM LUMEN	α	€
TR45505	■ NOIR MAT	ALUMINIUM	20W	2700K 3000K 4000K	2300Lm (4000K)	1450Lm (4000K)	40°	165,00
TR45535	▬ NOIR MAT - BLANC MAT	ALUMINIUM	20W	2700K 3000K 4000K	2300Lm (4000K)	1450Lm (4000K)	40°	170,00
TR45508	▬ NOIR MAT - DORÉ	ALUMINIUM	20W	2700K 3000K 4000K	2300Lm (4000K)	1450Lm (4000K)	40°	170,00
TR45506	▬ NOIR MAT - OR ROSE	ALUMINIUM	20W	2700K 3000K 4000K	2300Lm (4000K)	1450Lm (4000K)	40°	170,00



RAITO 1

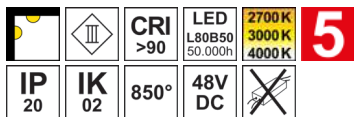

- Module linéaire pour DECO TRACK 48.
- 2700K, 3000K ou 4000K au choix via un interrupteur sur l'adaptateur.
- Dimmable avec un convertisseur DALI-PUSH (CD184, CD185).

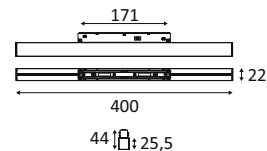

RAITO 1	COULEUR	MATIÈRE	P	CCT	LED LUMEN	SYSTEM LUMEN	α	€
TR44505	■ NOIR MAT	ALUMINIUM	11W	2700K 3000K 4000K	1950Lm (4000K)	1005Lm (4000K)	105°	155,00

RAITO 2

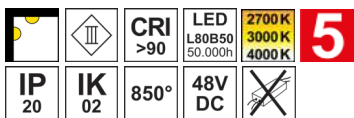

- Module linéaire pour DECO TRACK 48.
- 2700K, 3000K ou 4000K au choix via un interrupteur sur l'adaptateur.
- Dimmable avec un convertisseur DALI-PUSH (CD184, CD185).

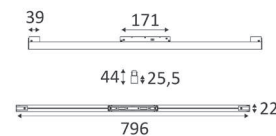

RAITO 2	COULEUR	MATIÈRE	P	CCT	LED LUMEN	SYSTEM LUMEN	α	€
TR44605	■ NOIR MAT	ALUMINIUM	18W	2700K 3000K 4000K	3000Lm (4000K)	1785Lm (4000K)	105°	255,00



BORU 1

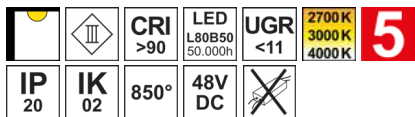

- Module linéaire à basse luminance pour DECO TRACK 48.
- 2700K, 3000K ou 4000K au choix via un interrupteur sur l'adaptateur.
- Dimmable avec un convertisseur DALI-PUSH (CD184, CD185).

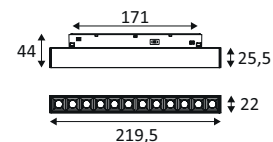

BORU 1	COULEUR	MATIÈRE	P	CCT	LED LUMEN	SYSTEM LUMEN	α	€
TR44705	■ NOIR MAT	ALUMINIUM	12W	2700K 3000K 4000K	1350Lm (4000K)	930Lm (4000K)	40°	165,00

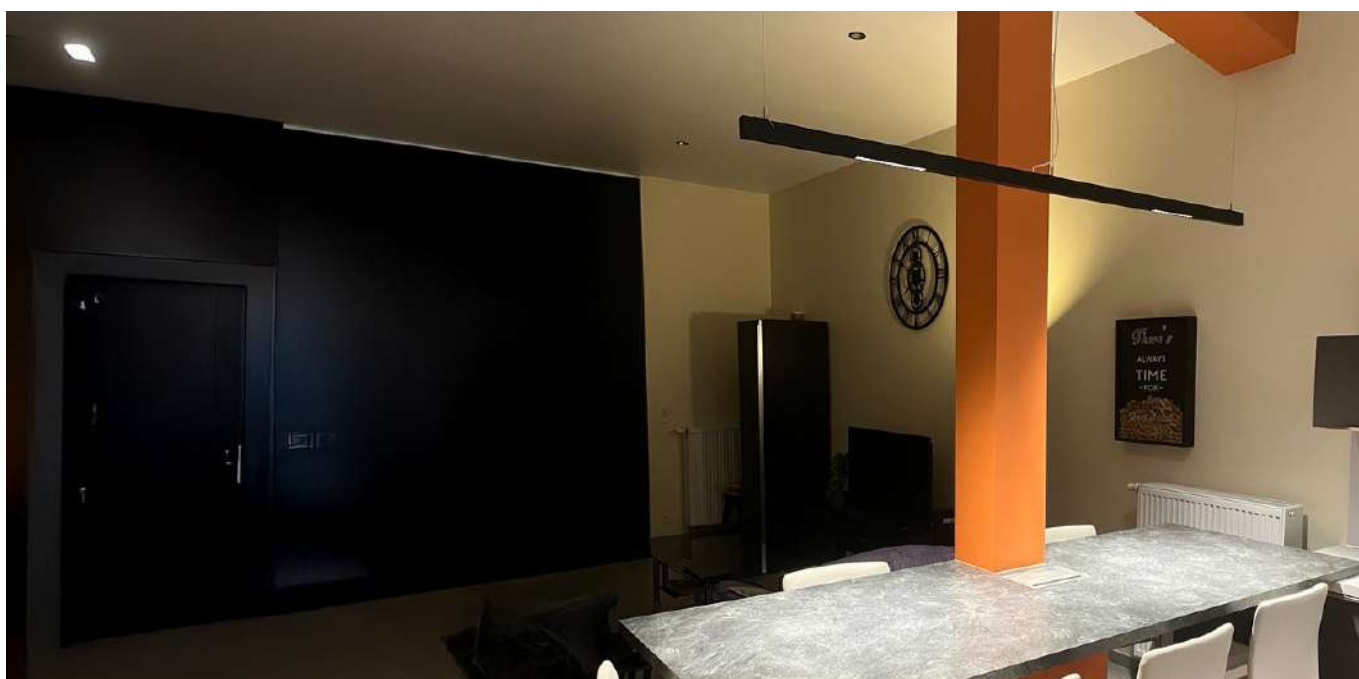

BORU 2



- Module linéaire à basse luminance pour DECO TRACK 48.
- 2700K, 3000K ou 4000K au choix via un interrupteur sur l'adaptateur.
- Dimmable avec un convertisseur DALI-PUSH (CD184, CD185).

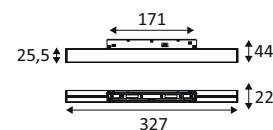

BORU 2	COULEUR	MATIÈRE	P	CCT	LED LUMEN	SYSTEM LUMEN	α	€
TR44805	■ NOIR MAT	ALUMINIUM	21W	2700K 3000K 4000K	2250Lm (4000K)	1505Lm (4000K)	40°	205,00

BORU 3

		CRI >90	LED L80B50 50.000h	UGR <12	2700K 3000K 4000K	5
IP 20	IK 02	850°	48V DC			

- Module linéaire à basse luminance pour DECO TRACK 48.
- 2700K, 3000K ou 4000K au choix via un interrupteur sur l'adaptateur.
- Dimmable avec un convertisseur DALI-PUSH (CD184, CD185).

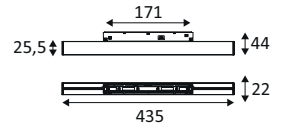

BORU 3	COULEUR	MATIÈRE	P	CCT	LED LUMEN	SYSTEM LUMEN	α	€
TR44905	NOIR MAT	ALUMINIUM	25W	2700K 3000K 4000K	2700Lm (4000K)	2020Lm (4000K)	40°	310,00

BORU 4

		CRI >90	LED L80B50 50.000h	UGR <10	2700K 3000K 4000K	5
IP 20	IK 02	850°	48V DC			

- Module linéaire à basse luminance pour DECO TRACK 48.
- 2700K, 3000K ou 4000K au choix via un interrupteur sur l'adaptateur.
- Dimmable avec un convertisseur DALI-PUSH (CD184, CD185).

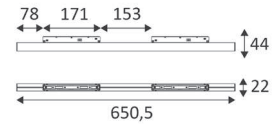

BORU 4	COULEUR	MATIÈRE	P	CCT	LED LUMEN	SYSTEM LUMEN	α	€
TR45005	NOIR MAT	ALUMINIUM	40W	2700K 3000K 4000K	4000Lm (4000K)	3100Lm (4000K)	40°	410,00



MEKA

		CRI >90	LED L80B50 50.000h	UGR <10	2700K 3000K 4000K	5
IP 20	IK 02	90°	850°	48V DC		

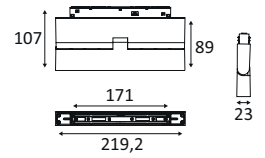

- Module linéaire orientable à basse luminance pour DECO TRACK 48.
- 2700K, 3000K ou 4000K au choix via un interrupteur sur l'adaptateur.
- Dimmable avec un convertisseur DALI-PUSH (CD184, CD185).

MEKA	COULEUR	MATIÈRE	P	CCT	LED LUMEN	SYSTEM LUMEN	α	€
TR45105	■ NOIR MAT	ALUMINIUM	12W	2700K 3000K 4000K	1350Lm (4000K)	1000Lm (4000K)	40°	247,00



LIGNES CONTINUES

LINEAR 1 C



LINEAR C : MISE EN LIGNE

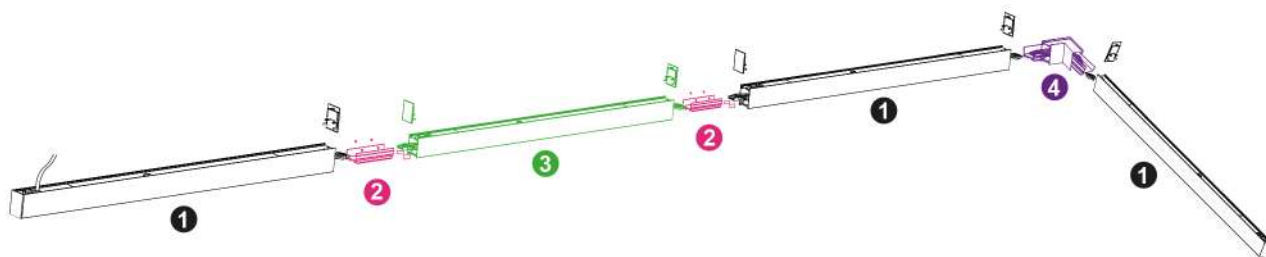

① CL100 / CL108 = **LINEAR C**

ACCESSOIRES À COMMANDER SÉPARÉMENT :

- ② CL102 = CONNEXION MÉCANIQUE
- ③ CL104 = MODULE ÉLECTRIFIÉ 120cm
- ④ CL105 = CONNEXION L

LINEAR P : MISE EN LIGNE

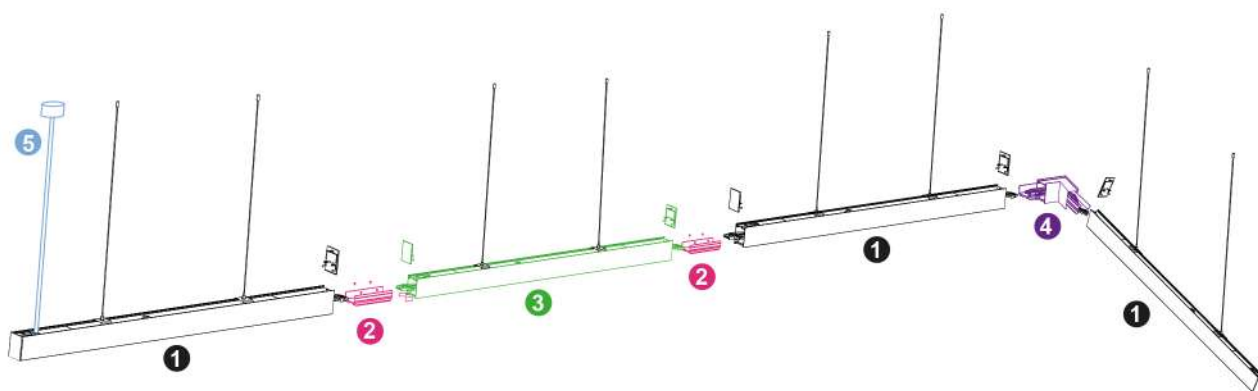

① CL101 / CL109 = **LINEAR P**

ACCESSOIRES À COMMANDER SÉPARÉMENT :

- ② CL102 = CONNEXION MÉCANIQUE
- ③ CL110 = MODULE ÉLECTRIFIÉ 120cm
- ④ CL105 = CONNEXION L
- ⑤ CL103 = CÂBLE D'ALIMENTATION 200cm + BASE



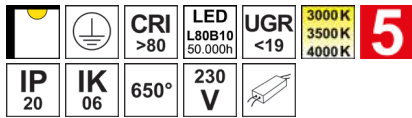



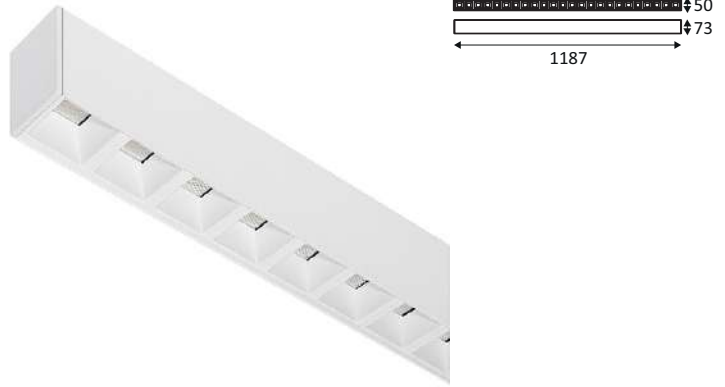











LINEAR 1 C



- Plafonnier linéaire.
- Réflecteur basse luminance.
- 3000K, 3500K ou 4000K au choix via un interrupteur à l'arrière du luminaire.
- Convertisseur non dimmable ou dimmable DALI-push intégré dans l'appareil.
- Possibilité de mise en ligne jusqu'à maximum 25 luminaires.
- Connexion mécanique linéaire à commander séparément.
- Connexions électriques rapides incluses dans le luminaire.



LINEAR 1 C	COULEUR	MATIÈRE	P	CCT	L(MM)	LED LUMEN	SYSTEM LUMEN	α	€
NON DIMMABLE									
CL10005	■ NOIR MAT	ALUMINIUM	38W	3000K 3500K 4000K	1187	6625Lm (4000K)	2890Lm (4000K)	75°	185,00
CL10017	▣ NOIR MAT - ARGENT	ALUMINIUM	38W	3000K 3500K 4000K	1187	6625Lm (4000K)	4580Lm (4000K)	75°	185,00
CL10030	□ BLANC MAT	ALUMINIUM	38W	3000K 3500K 4000K	1187	6625Lm (4000K)	4770Lm (4000K)	75°	185,00
CL10053	▣ BLANC MAT - ARGENT	ALUMINIUM	38W	3000K 3500K 4000K	1187	6625Lm (4000K)	4580Lm (4000K)	75°	185,00
DIMMABLE DALI									
CL10005DA	■ NOIR MAT	ALUMINIUM	38W	3000K 3500K 4000K	1187	6625Lm (4000K)	2890Lm (4000K)	75°	235,00
CL10017DA	▣ NOIR MAT - ARGENT	ALUMINIUM	38W	3000K 3500K 4000K	1187	6625Lm (4000K)	4580Lm (4000K)	75°	235,00
CL10030DA	□ BLANC MAT	ALUMINIUM	38W	3000K 3500K 4000K	1187	6625Lm (4000K)	4770Lm (4000K)	75°	235,00
CL10053DA	▣ BLANC MAT - ARGENT	ALUMINIUM	38W	3000K 3500K 4000K	1187	6625Lm (4000K)	4580Lm (4000K)	75°	235,00

ACCESSOIRES	COULEUR	MATIÈRE	DESCRIPTION		€
CL10220		ALUMINIUM	CONNEXION MECANIQUE	 	7,00
CL10405	■ NOIR MAT	ALUMINIUM	MODULE ELECTRIFIE 120CM	 	85,00
CL10430	□ BLANC MAT	ALUMINIUM	MODULE ELECTRIFIE 120CM	 	85,00
CL10505	■ NOIR MAT	ALUMINIUM	CONNEXION L	 	55,00
CL10530	□ BLANC MAT	ALUMINIUM	CONNEXION L	 	55,00
CL10605	■ NOIR MAT	ALUMINIUM	CONNEXION T	 	72,00
CL10630	□ BLANC MAT	ALUMINIUM	CONNEXION T	 	72,00
CL10705	■ NOIR MAT	ALUMINIUM	CONNEXION X	 	90,00
CL10730	□ BLANC MAT	ALUMINIUM	CONNEXION X	 	90,00





LINEAR 2 C

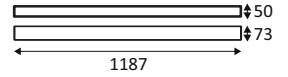
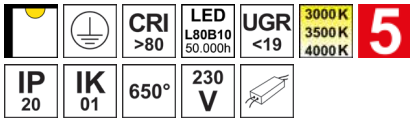

- Plafonnier linéaire.
- Diffuseur PC à structure prismatique.
- Multi-puissance : 21 ou 32W au choix via un interrupteur à l'arrière du luminaire.
- 3000K, 3500K ou 4000K au choix via un interrupteur à l'arrière du luminaire.
- Convertisseur non dimmable ou dimmable DALI-push intégré dans l'appareil.
- Possibilité de mise en ligne jusqu'à maximum 25 luminaires.
- Connexion mécanique linéaire à commander séparément.
- Connexions électriques rapides incluses dans le luminaire.

LINEAR 2 C	COULEUR	MATIÈRE	LED	CCT	L(MM)	LED LUMEN	SYSTEM LUMEN	α	€
NON DIMMABLE									
CL10805	■ NOIR MAT	ALUMINIUM	21W 32W	3000K 3500K 4000K	1187	3350 (21W 4000K) 5100 (32W 4000K)	2045 (21W 4000K) 2990 (32W 4000K)	75°	175,00
CL10830	■ BLANC MAT	ALUMINIUM	21W 32W	3000K 3500K 4000K	1187	3350 (21W 4000K) 5100 (32W 4000K)	2560 (21W 4000K) 3740 (32W 4000K)	75°	175,00
DIMMABLE DALI									
CL10805DA	■ NOIR MAT	ALUMINIUM	21W 32W	3000K 3500K 4000K	1187	3350 (21W 4000K) 5100 (32W 4000K)	2040 (21W 4000K) 2990 (32W 4000K)	75°	225,00
CL10830DA	■ BLANC MAT	ALUMINIUM	21W 32W	3000K 3500K 4000K	1187	3350 (21W 4000K) 5100 (32W 4000K)	2560 (21W 4000K) 3740 (32W 4000K)	75°	225,00

ACCESSOIRES	COULEUR	MATIÈRE	DESCRIPTION		€
CL10220		ALUMINIUM	CONNEXION MECANIQUE		7,00
CL10405	■ NOIR MAT	ALUMINIUM	MODULE ELECTRIFIE 120CM		85,00
CL10430	■ BLANC MAT	ALUMINIUM	MODULE ELECTRIFIE 120CM		85,00
CL10505	■ NOIR MAT	ALUMINIUM	CONNEXION L		55,00
CL10530	■ BLANC MAT	ALUMINIUM	CONNEXION L		55,00
CL10605	■ NOIR MAT	ALUMINIUM	CONNEXION T		72,00
CL10630	■ BLANC MAT	ALUMINIUM	CONNEXION T		72,00
CL10705	■ NOIR MAT	ALUMINIUM	CONNEXION X		90,00
CL10730	■ BLANC MAT	ALUMINIUM	CONNEXION X		90,00

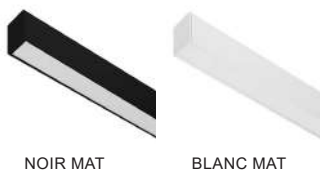

NOIR MAT

BLANC MAT

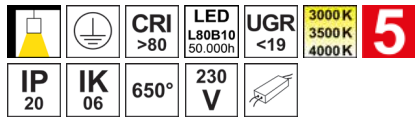
LINEAR 1 P



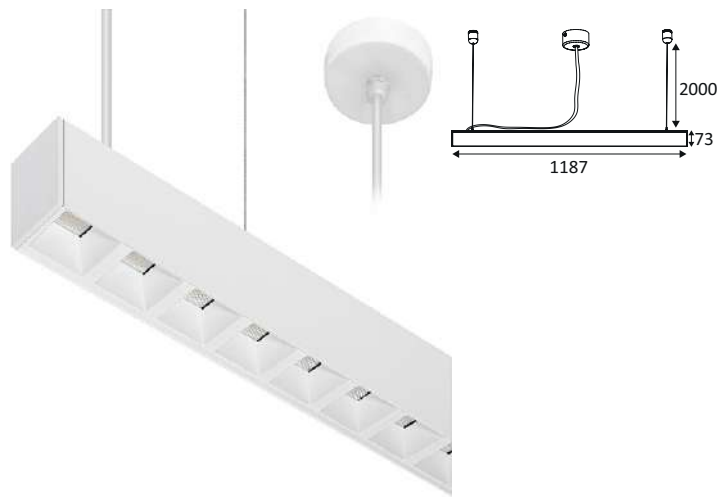



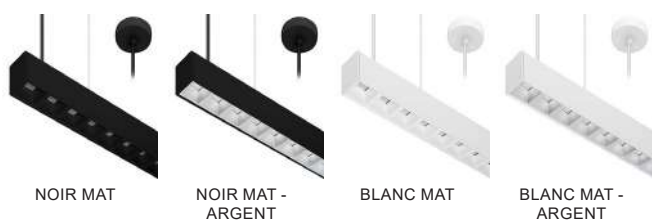



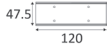







- Suspension linéaire.
- Réflecteur basse luminance.
- 3000K, 3500K ou 4000K au choix via un interrupteur à l'arrière du luminaire.
- Livraison avec câbles de suspension blancs ou noirs (réglables 2.00m max).
- Base ronde et câble d'alimentation blancs ou noirs (L: 2.00m) à commander séparément.
- Convertisseur non dimmable ou dimmable DALI-push intégré dans l'appareil.
- Possibilité de mise en ligne jusqu'à maximum 25 luminaires.
- Connexion mécanique linéaire à commander séparément.
- Connexions électriques rapides incluses dans le luminaire.



LINEAR 1 P	COULEUR	MATIÈRE	P	CCT	L(MM)	LED LUMEN	SYSTEM LUMEN	α	€
NON DIMMABLE									
CL10105	■ NOIR MAT	ALUMINIUM	38W	3000K 3500K 4000K	1187	6625Lm (4000K)	2890Lm (4000K)	75°	190,00
CL10117	▣ NOIR MAT - ARGENT	ALUMINIUM	38W	3000K 3500K 4000K	1187	6625Lm (4000K)	4580Lm (4000K)	75°	190,00
CL10130	□ BLANC MAT	ALUMINIUM	38W	3000K 3500K 4000K	1187	6625Lm (4000K)	4770Lm (4000K)	75°	190,00
CL10153	▣ BLANC MAT - ARGENT	ALUMINIUM	38W	3000K 3500K 4000K	1187	6625Lm (4000K)	4580Lm (4000K)	75°	190,00
DIMMABLE DALI									
CL10105DA	■ NOIR MAT	ALUMINIUM	38W	3000K 3500K 4000K	1187	6625Lm (4000K)	2890Lm (4000K)	75°	240,00
CL10117DA	▣ NOIR MAT - ARGENT	ALUMINIUM	38W	3000K 3500K 4000K	1187	6625Lm (4000K)	4580Lm (4000K)	75°	240,00
CL10130DA	□ BLANC MAT	ALUMINIUM	38W	3000K 3500K 4000K	1187	6625Lm (4000K)	4770Lm (4000K)	75°	240,00
CL10153DA	▣ BLANC MAT - ARGENT	ALUMINIUM	38W	3000K 3500K 4000K	1187	6625Lm (4000K)	4580Lm (4000K)	75°	240,00





ACCESSOIRES	COULEUR	MATIÈRE	DESCRIPTION		€
CL10220		ALUMINIUM	CONNEXION MECANIQUE	 	7,00
CL11005	NOIR MAT	ALUMINIUM	MODULE ELECTRIFIE 120CM	 	100,00
CL11030	BLANC MAT	ALUMINIUM	MODULE ELECTRIFIE 120CM	 	100,00
CL10305	NOIR		CABLE D'ALIMENTATION 200CM + BASE		13,50
CL10305DA	NOIR		CABLE D'ALIMENTATION DALI 200CM + BASE		18,50
CL10330	BLANC		CABLE D'ALIMENTATION 200CM + BASE		13,50
CL10330DA	BLANC		CABLE D'ALIMENTATION DALI 200CM + BASE		18,50
CL10505	NOIR MAT	ALUMINIUM	CONNEXION L	 	55,00
CL10530	BLANC MAT	ALUMINIUM	CONNEXION L		55,00
CL10605	NOIR MAT	ALUMINIUM	CONNEXION T	 	72,00
CL10630	BLANC MAT	ALUMINIUM	CONNEXION T		72,00
CL10705	NOIR MAT	ALUMINIUM	CONNEXION X	 	90,00
CL10730	BLANC MAT	ALUMINIUM	CONNEXION X		90,00

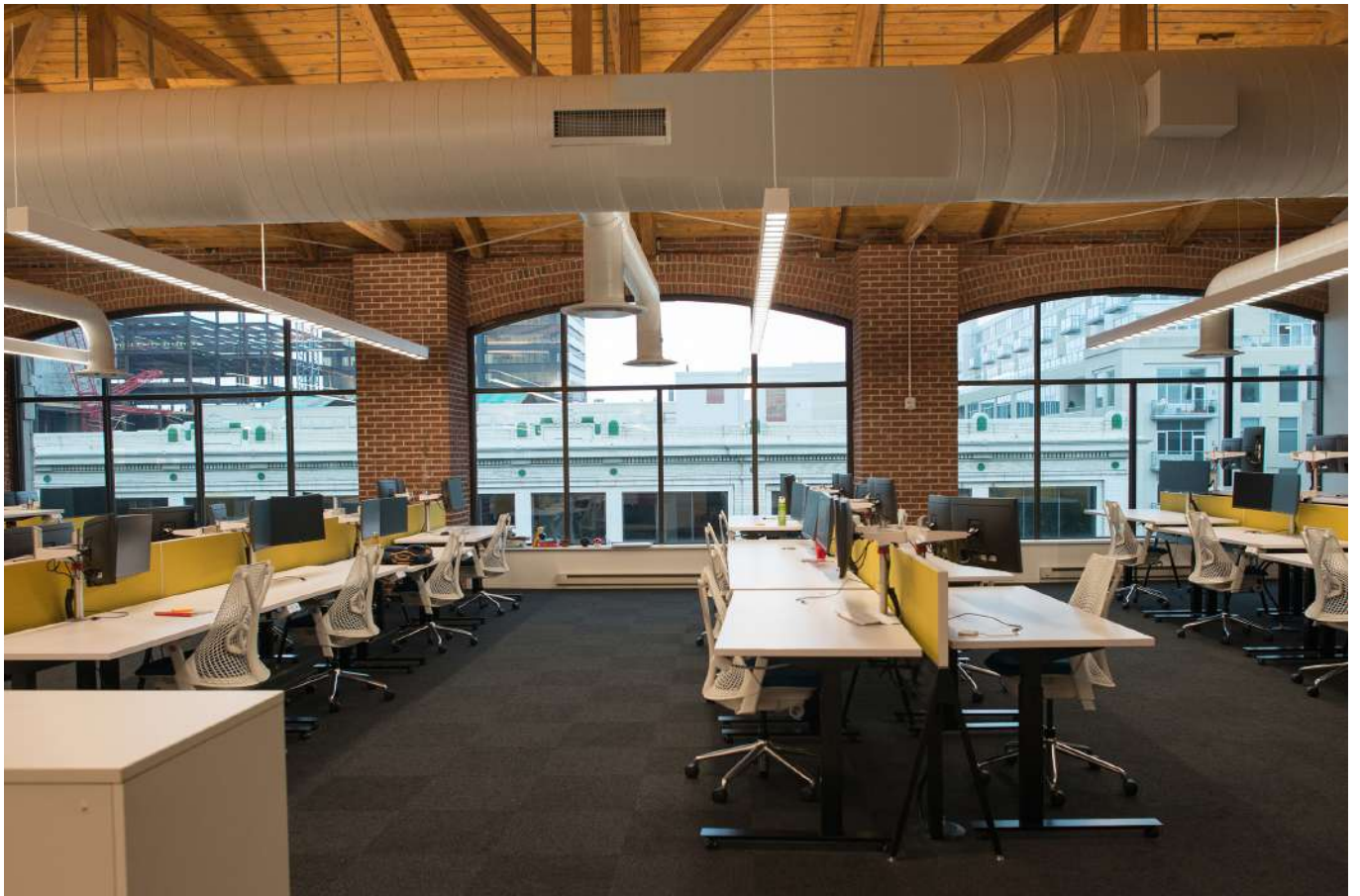

LINEAR 2 P

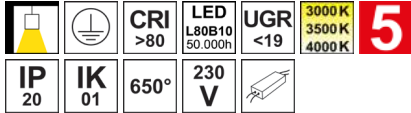



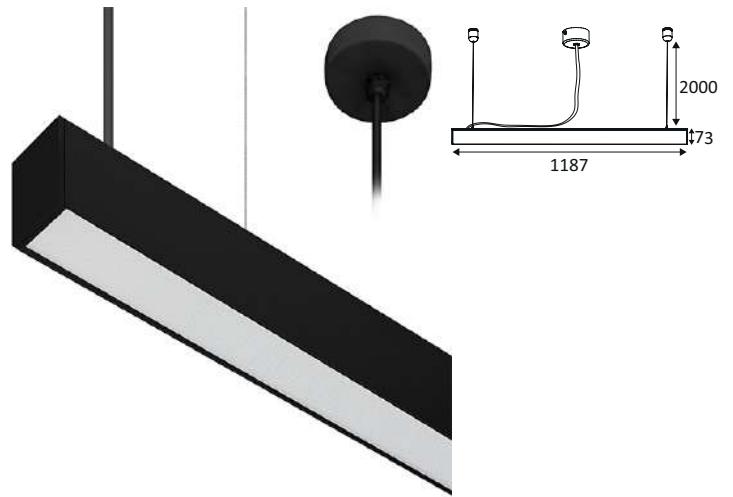



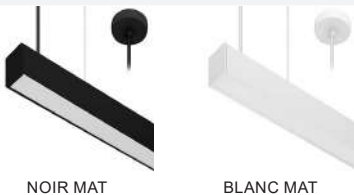



- Suspension linéaire.
- Diffuseur PC à structure prismatique.
- Multi-puissance : 21 ou 32W au choix via un interrupteur à l'arrière du luminaire.
- 3000K, 3500K ou 4000K au choix via un interrupteur à l'arrière du luminaire.
- Livrée avec câbles de suspension blancs ou noirs (réglables 2.00m max).
- Base ronde et câble d'alimentation blancs ou noirs (L: 2.00m) à commander séparément.
- Convertisseur non dimmable ou dimmable DALI-push intégré dans l'appareil.
- Possibilité de mise en ligne jusqu'à maximum 25 luminaires.
- Connexion mécanique linéaire à commander séparément.
- Connexions électriques rapides incluses dans le luminaire.



LINEAR 2 P	COULEUR	MATIÈRE	LED	CCT	L(MM)	LED LUMEN	SYSTEM LUMEN	α	€
NON DIMMABLE									
CL10905	■ NOIR MAT	ALUMINIUM	21W 32W	3000K 3500K 4000K	1187	3350 (21W 4000K) 5100 (32W 4000K)	2045 (21W 4000K) 2990 (32W 4000K)	75°	180,00
CL10930	■ BLANC MAT	ALUMINIUM	21W 32W	3000K 3500K 4000K	1187	3350 (21W 4000K) 5100 (32W 4000K)	2560 (21W 4000K) 3740 (32W 4000K)	75°	180,00
DIMMABLE DALI									
CL10905DA	■ NOIR MAT	ALUMINIUM	21W 32W	3000K 3500K 4000K	1187	3350 (21W 4000K) 5100 (32W 4000K)	2045 (21W 4000K) 2990 (32W 4000K)	75°	230,00
CL10930DA	■ BLANC MAT	ALUMINIUM	21W 32W	3000K 3500K 4000K	1187	3350 (21W 4000K) 5100 (32W 4000K)	2560 (21W 4000K) 3740 (32W 4000K)	75°	230,00





ACCESSOIRES	COULEUR	MATIÈRE	DESCRIPTION		€
CL10220		ALUMINIUM	CONNEXION MECANIQUE		47.5 120 7,00
CL11005	NOIR MAT	ALUMINIUM	MODULE ELECTRIFIE 120CM		2000 1200 100,00
CL11030	BLANC MAT	ALUMINIUM	MODULE ELECTRIFIE 120CM		100,00
CL10305	NOIR		CABLE D'ALIMENTATION 200CM + BASE		13,50
CL10305DA	NOIR		CABLE D'ALIMENTATION DALI 200CM + BASE		18,50
CL10330	BLANC		CABLE D'ALIMENTATION 200CM + BASE		13,50
CL10330DA	BLANC		CABLE D'ALIMENTATION DALI 200CM + BASE		18,50
CL10505	NOIR MAT	ALUMINIUM	CONNEXION L		99 169 55,00
CL10530	BLANC MAT	ALUMINIUM	CONNEXION L		55,00
CL10605	NOIR MAT	ALUMINIUM	CONNEXION T		288 148 169 99 72,00
CL10630	BLANC MAT	ALUMINIUM	CONNEXION T		72,00
CL10705	NOIR MAT	ALUMINIUM	CONNEXION X		288 148 90,00
CL10730	BLANC MAT	ALUMINIUM	CONNEXION X		90,00

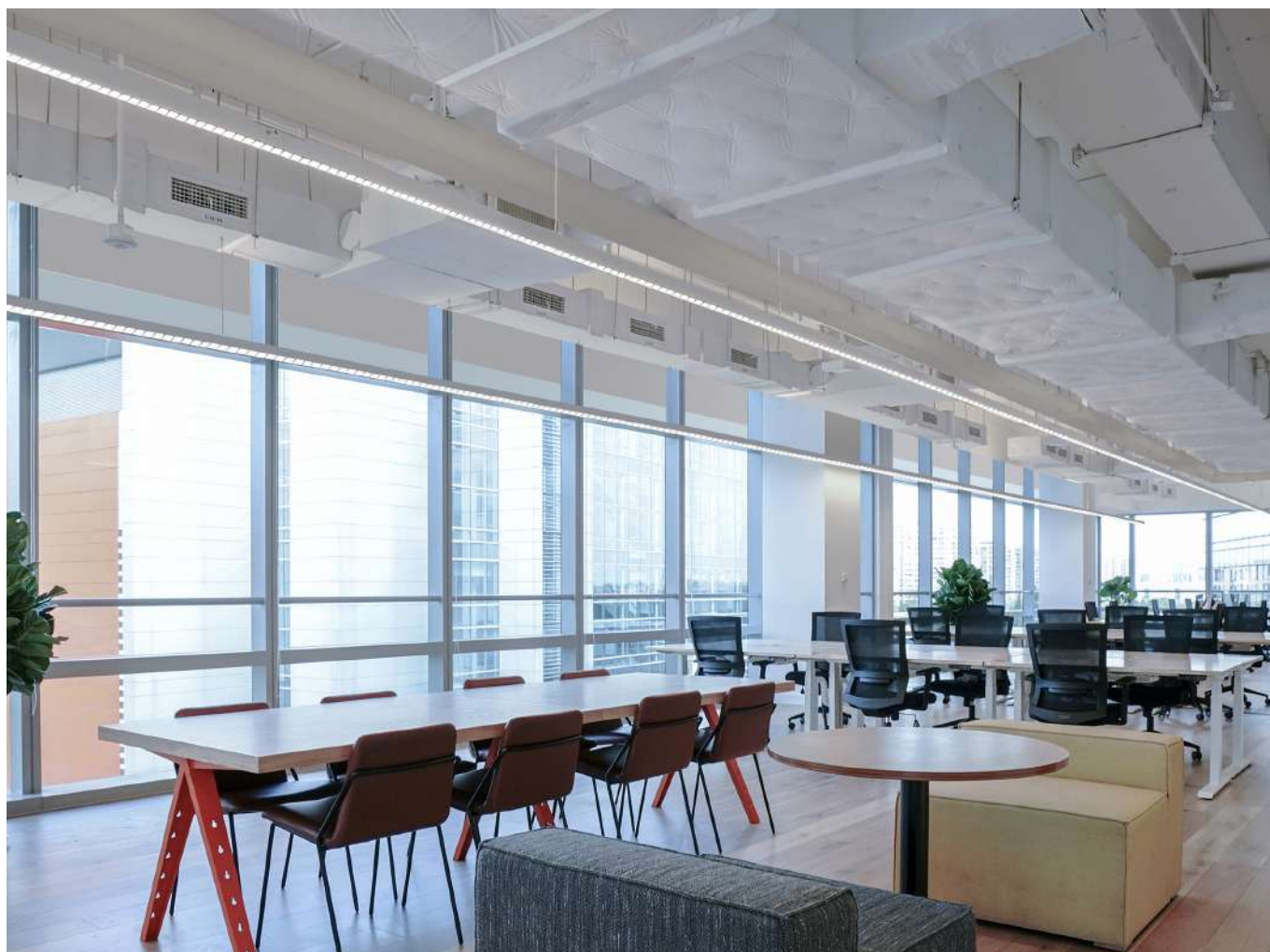

HUBLOTS

MINI TIMY E27



- Applique murale ou plafonnier pour éclairage intérieur et extérieur.
- Avec clé et vis anti-vandale.

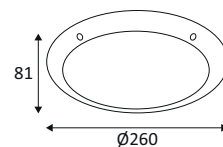

MINI TIMY E27	COULEUR	MATIÈRE	DOUILLE	LAMPE	WATT MAX	€
OU44530	■ NOIR	POLYCARBONATE	E27	CLASSIC A	23W	25,00
OU44531	■ BLANC	POLYCARBONATE	E27	CLASSIC A	23W	25,00



NOIR



BLANC

MINI TIMY SENSOR E27



- Applique murale ou plafonnier pour éclairage intérieur et extérieur.
- Avec détecteur HF 360°, zone de détection réglable max. 10m de diamètre.
- Fonction maître/esclave possible en association avec le MINI TIMY E27.
- Avec clé et vis anti-vandale.

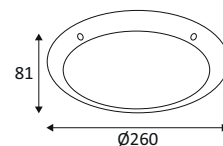

MINI TIMY SENSOR E27	COULEUR	MATIÈRE	DOUILLE	LAMPE	WATT MAX	€
OU44630	■ NOIR	POLYCARBONATE	E27	CLASSIC A	23W	45,00
OU44631	■ BLANC	POLYCARBONATE	E27	CLASSIC A	23W	45,00



NOIR



BLANC



MINI TIMY EVO

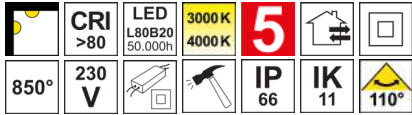

- Applique murale ou plafonnier pour éclairage intérieur et extérieur.
- 3000K ou 4000K au choix via un interrupteur dans le luminaire.
- Avec clé et vis anti-vandale.
- Convertisseur non dimmable intégré dans l'appareil.
- Multi-puissance : 7 ou 12W au choix via un interrupteur sur le convertisseur.
- Convertisseur ou source de remplacement disponibles séparément.

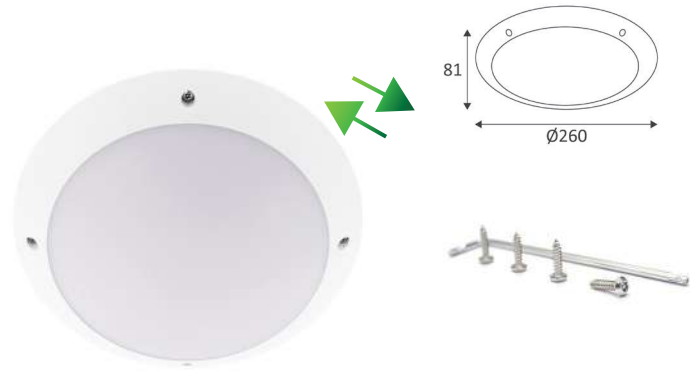

MINI TIMY EVO	COULEUR	MATIÈRE	P	CCT	LED LUMEN	SYSTEM LUMEN	α	€
BU10505 NEW	NOIR MAT	POLYCARBONATE	7 - 12W	3000K 4000K	1145Lm (6,1W 4000K) 1805Lm (10,5W 4000K)	805Lm (7W 4000K) 1225Lm (12W 4000K)	110°	45,00
BU10530 NEW	BLANC MAT	POLYCARBONATE	7 - 12W	3000K 4000K	1145Lm (6,1W 4000K) 1805Lm (10,5W 4000K)	805Lm (7W 4000K) 1225Lm (12W 4000K)	110°	45,00

CONVERTISSEURS ET SOURCES		€
CDBU105 NEW	MINI TIMY EVO DRIVER 12W 70-120MA CC	13,00
LPBU105 NEW	SOURCE LED MINI TIMY EVO 10,5W 1805Lm	20,00



MINI TIMY SENSOR EVO



- Applique murale ou plafonnier pour éclairage intérieur et extérieur.
- 3000K ou 4000K au choix via un interrupteur dans le luminaire.
- Avec détecteur HF 360°, zone de détection réglable max. 10m de diamètre.
- Fonction maître/esclave.
- Avec clé et vis anti-vandale.
- Convertisseur non dimmable intégré dans l'appareil.
- Multi-puissance : 8 ou 13W au choix via un interrupteur sur le convertisseur.
- Convertisseur ou source de remplacement disponibles séparément.



MINI TIMY SENSOR EVO	COULEUR	MATIÈRE	P	CCT	LED LUMEN	SYSTEM LUMEN	α	€
BU10605 NEW	NOIR MAT	POLYCARBONATE	8 - 13W	3000K 4000K	1145Lm (6,1W 4000K) 1805Lm (10,5W 4000K)	805Lm (8W 4000K) 1225Lm (13W 4000K)	110°	75,00
BU10630 NEW	BLANC MAT	POLYCARBONATE	8 - 13W	3000K 4000K	145Lm (6,1W 4000K) 1805Lm (10,5W 4000K)	805Lm (8W 4000K) 1225Lm (13W 4000K)	110°	75,00

CONVERTISSEURS ET SOURCES		€
CDBU105 NEW	MINI TIMY EVO DRIVER 12W 70-120MA CC	13,00
LPBU105 NEW	SOURCE LED MINI TIMY EVO 10,5W 1805Lm	20,00



TIMY EVO



- Applique murale ou plafonnier pour éclairage intérieur et extérieur.
- 3000K ou 4000K au choix via un interrupteur dans le luminaire.
- Avec clé et vis anti-vandale.
- Convertisseur non dimmable intégré dans l'appareil.
- Multi-puissance : 15, 18 ou 22W au choix via un interrupteur sur le convertisseur.
- Convertisseur ou source de remplacement disponibles séparément.

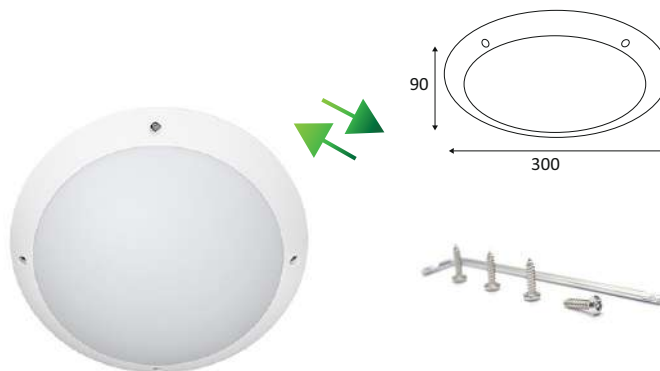

TIMY EVO	COULEUR	MATIÈRE	P	CCT	LED LUMEN	SYSTEM LUMEN	α	€
BU10705 NEW	NOIR MAT	POLYCARBONATE	15 - 18 - 22W	3000K 4000K	2175 (13,6W 3000K) - 2370 (13,6W 4000K) 2550 (16,4W 3000K) - 2770 (16,4W 4000K) 2925 (20W 3000K) - 3235 (20W 4000K)	1670Lm (15W 4000K) 1960Lm (18W 4000K) 2190Lm (22W 4000K)	110°	85,00
BU10730 NEW	BLANC MAT	POLYCARBONATE	15 - 18 - 22W	3000K 4000K	2175 (13,6W 3000K) - 2370 (13,6W 4000K) 2550 (16,4W 3000K) - 2770 (16,4W 4000K) 2925 (20W 3000K) - 3235 (20W 4000K)	1670Lm (15W 4000K) 1960Lm (18W 4000K) 2190Lm (22W 4000K)	110°	85,00

CONVERTISSEURS ET SOURCES		€
CDBU107 NEW	DRIVER TIMY EVO 22W 160-190-230MA CC	16,00
LPBU107 NEW	SOURCE LED TIMY EVO 20W 3235Lm	30,00



NOIR MAT



BLANC MAT

TIMY SENSOR EVO



- Applique murale ou plafonnier pour éclairage intérieur et extérieur.
- 3000K ou 4000K au choix via un interrupteur dans le luminaire.
- Avec détecteur HF 360°, zone de détection réglable max. 10m de diamètre.
- Fonction maître/esclave.
- Avec clé et vis anti-vandale.
- Convertisseur non dimmable intégré dans l'appareil.
- Multi-puissance : 16, 19 ou 23W au choix via un interrupteur sur le convertisseur.
- Convertisseur ou source de remplacement disponibles séparément.



TIMY SENSOR EVO	COULEUR	MATIÈRE	P	CCT	LED LUMEN	SYSTEM LUMEN	α	€
BU10805 NEW	NOIR MAT	POLYCARBONATE	16 - 19 - 23W	3000K 4000K	2175 (13,6W 3000K) - 2370 (13,6W 4000K) 2550 (16,4W 3000K) - 2770 (16,4W 4000K) 2925 (20W 3000K) - 3235 (20W 4000K)	1670Lm (15W 4000K) 1960Lm (18W 4000K) 2190Lm (22W 4000K)	110°	105,00
BU10830 NEW	BLANC MAT	POLYCARBONATE	16 - 19 - 23W	3000K 4000K	2175 (13,6W 3000K) - 2370 (13,6W 4000K) 2550 (16,4W 3000K) - 2770 (16,4W 4000K) 2925 (20W 3000K) - 3235 (20W 4000K)	1670Lm (15W 4000K) 1960Lm (18W 4000K) 2190Lm (22W 4000K)	110°	105,00

CONVERTISSEURS ET SOURCES		€
CDBU107 NEW	DRIVER TIMY EVO 22W 160-190-230MA CC	16,00
LPBU107 NEW	SOURCE LED TIMY EVO 20W 3235Lm	30,00



NOIR MAT



BLANC MAT

TIMY SENSOR EVO

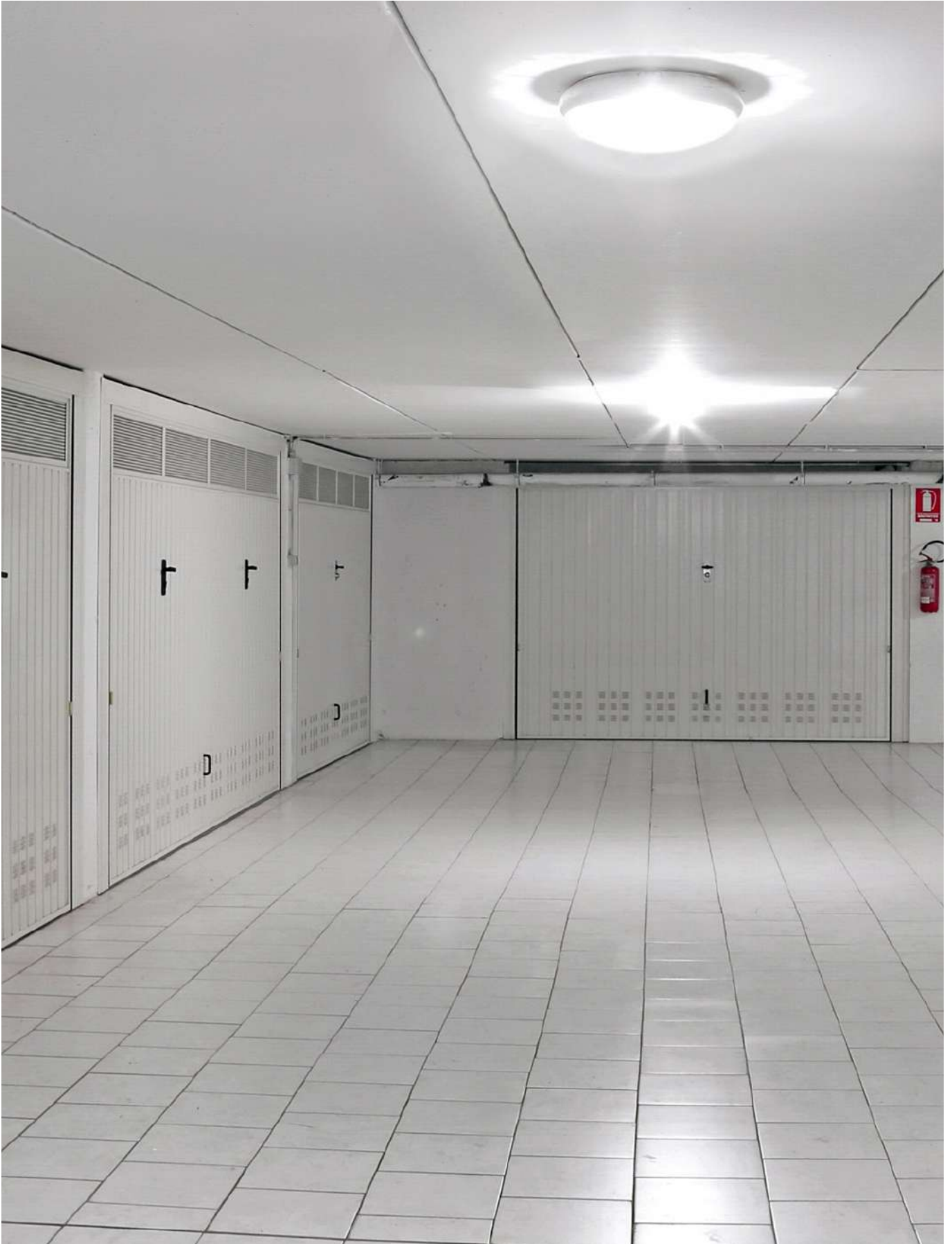

LIDY

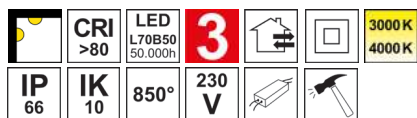

- Applique murale ou plafonnier pour éclairage intérieur et extérieur.
- 3000K ou 4000K au choix via un interrupteur dans le luminaire.
- Avec clé et vis anti-vandale.
- Convertisseur non dimmable intégré dans l'appareil.

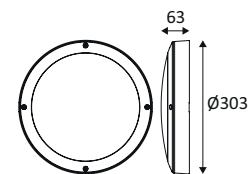

LIDY	COULEUR	MATIÈRE	P	CCT	LED LUMEN	SYSTEM LUMEN	α	€
BU10105	■ NOIR	POLYCARBONATE	24W	3000K 4000K	4010Lm (4000K)	2655Lm (4000K)	110°	70,00
BU10130	■ BLANC	POLYCARBONATE	24W	3000K 4000K	4010Lm (4000K)	2655Lm (4000K)	110°	70,00



NOIR



BLANC

LIDY SENSOR



- Applique murale ou plafonnier pour éclairage intérieur et extérieur.
- 3000K ou 4000K au choix via un interrupteur dans le luminaire.
- Avec détecteur HF 360°, zone de détection réglable max. 10m de diamètre.
- Fonction maître/esclave possible en association avec le LIDY.
- Avec clé et vis anti-vandale.
- Convertisseur non dimmable intégré dans l'appareil.

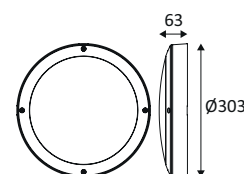

LIDY SENSOR	COULEUR	MATIÈRE	P	CCT	LED LUMEN	SYSTEM LUMEN	α	€
BU10205	■ NOIR	POLYCARBONATE	24W	3000K 4000K	4010Lm (4000K)	2655Lm (4000K)	110°	90,00
BU10230	■ BLANC	POLYCARBONATE	24W	3000K 4000K	4010Lm (4000K)	2655Lm (4000K)	110°	90,00



NOIR



BLANC



NEW

LIDY SENSOR IR



- Applique murale ou plafonnier pour éclairage intérieur et extérieur.
- 3000K ou 4000K au choix via un interrupteur dans le luminaire.
- Avec détecteur IR 360°, zone de détection max. 6m de diamètre.
- Avec clé et vis anti-vandale.
- Convertisseur non dimmable intégré dans l'appareil.



LIDY SENSOR IR	COULEUR	MATIÈRE	P	CCT	LED LUMEN	SYSTEM LUMEN	α	€
BU10905 NEW	NOIR MAT	POLYCARBONATE	24W	3000K 4000K	3620Lm (4000K)	2590Lm (4000K)	110°	115,00
BU10930 NEW	BLANC MAT	POLYCARBONATE	24W	3000K 4000K	3620Lm (4000K)	2590Lm (4000K)	110°	115,00



NOIR MAT



BLANC MAT



LIDY A

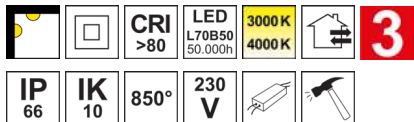

- Applique murale asymétrique pour éclairage intérieur et extérieur.
- 3000K ou 4000K au choix via un interrupteur dans le luminaire.
- Avec clé et vis anti-vandale.
- Convertisseur non dimmable intégré dans l'appareil.

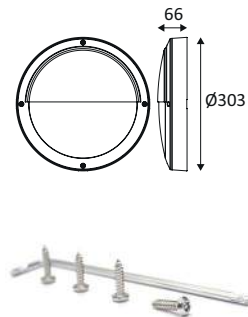

LIDY A	COULEUR	MATIÈRE	P	CCT	LED LUMEN	SYSTEM LUMEN	€
BU10305	NOIR	POLYCARBONATE	28W	3000K 4000K	4810Lm (4000K)	2930Lm (4000K)	75,00
BU10330	BLANC	POLYCARBONATE	28W	3000K 4000K	4810Lm (4000K)	2930Lm (4000K)	75,00



NOIR



BLANC

LIDY A SENSOR



- Applique murale asymétrique pour éclairage intérieur et extérieur.
- 3000K ou 4000K au choix via un interrupteur dans le luminaire.
- Avec détecteur HF 360°, zone de détection réglable max. 10m de diamètre.
- Fonction maître/esclave possible en association avec le LIDY A.
- Avec clé et vis anti-vandale.
- Convertisseur non dimmable intégré dans l'appareil.

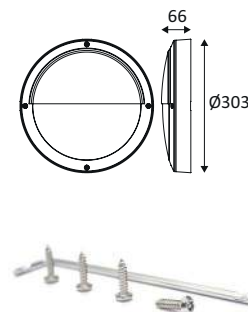

LIDY A SENSOR	COULEUR	MATIÈRE	P	CCT	LED LUMEN	SYSTEM LUMEN	€
BU10405	NOIR	POLYCARBONATE	28W	3000K 4000K	4810Lm (4000K)	2930Lm (4000K)	95,00
BU10430	BLANC	POLYCARBONATE	28W	3000K 4000K	4810Lm (4000K)	2930Lm (4000K)	95,00



NOIR



BLANC



LIDY A



WL94

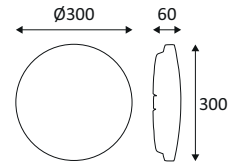
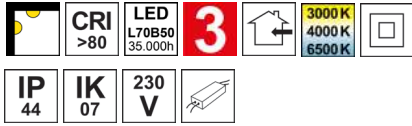

- Applique murale ou plafonnier pour éclairage intérieur.
- 3000K, 4000K ou 6500K au choix via un interrupteur à l'intérieur du luminaire.
- Convertisseur non dimmable intégré dans l'appareil.
- 4 versions disponibles : standard, avec détecteur HF, avec éclairage de secours ou avec détecteur HF & éclairage de secours.

WL94	COULEUR	MATIÈRE	P	CCT	LED LUMEN	SYSTEM LUMEN	α	€
STANDARD								
WL9410SCS	BLANC	POLYCARBONATE	10W	3000K 4000K 6500K	1300Lm (4000K)	1100Lm (4000K)	120°	47,00
WL9418SCS	BLANC	POLYCARBONATE	18W	3000K 4000K 6500K	2350Lm (4000K)	2000Lm (4000K)	120°	54,00
DÉTECTEUR HF								
WL9410MCS	BLANC	POLYCARBONATE	10W	3000K 4000K 6500K	1300Lm (4000K)	1100Lm (4000K)	120°	87,00
WL9418MCS	BLANC	POLYCARBONATE	18W	3000K 4000K 6500K	2350Lm (4000K)	2000Lm (4000K)	120°	94,00





ORKI

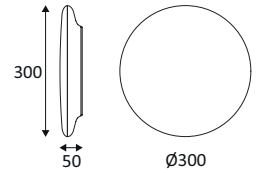
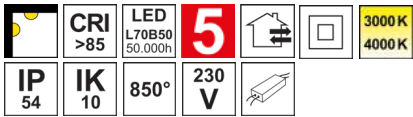

- Applique murale ou plafonnier pour éclairage intérieur et extérieur.
- 3000K ou 4000K au choix via un interrupteur à l'arrière du luminaire.
- Convertisseur non dimmable intégré dans l'appareil.

ORKI	COULEUR	MATIÈRE	P	CCT	LED LUMEN	SYSTEM LUMEN	α	€
OU41731	BLANC	POLYCARBONATE	18W	3000K 4000K	2730Lm (4000K)	1770Lm (4000K)	115°	80,00

ORKI SENSOR

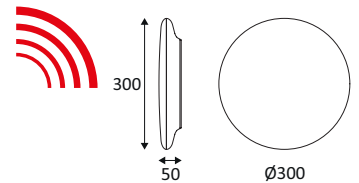

- Applique murale ou plafonnier pour éclairage intérieur et extérieur.
- 3000K ou 4000K au choix via un interrupteur à l'arrière du luminaire.
- Avec détecteur HF 360°, zone de détection réglable max. 10m de diamètre.
- Convertisseur non dimmable intégré dans l'appareil.

ORKI SENSOR	COULEUR	MATIÈRE	P	CCT	LED LUMEN	SYSTEM LUMEN	α	€
OU39731	BLANC	POLYCARBONATE	18W	3000K 4000K	2730Lm (4000K)	1770Lm (4000K)	115°	100,00

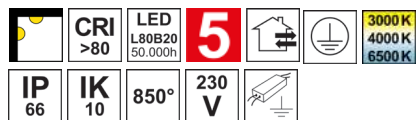

RÈGLETTES ÉTANCHES

POLAS VERSA



- Luminaire linéaire étanche.
- Diffuseur en polycarbonate.
- 3000K, 4000K ou 6500K au choix via un interrupteur dans le luminaire.
- Avec câblage traversant.
- Convertisseur non dimmable ou dimmable DALI intégré dans l'appareil.
- Clips de montage inclus; étriers et fils de suspension en option.
- Détecteur de mouvement et crépusculaire PIR en option : zone de détection max. 8m de diamètre, hauteur d'installation max. 6m, fonction maître/esclave.



POLAS VERSA	COULEUR	MATIÈRE	P	CCT	L(MM)	SYSTEM LUMEN	α	€
NON DIMMABLE								
POL30204	BLANC	POLYCARBONATE	31W	3000K 4000K 6500K	1300	4750Lm (4000K)	120°	50,00
POL30104	BLANC	POLYCARBONATE	43W	3000K 4000K 6500K	1600	6650Lm (4000K)	120°	60,00
DIMMABLE DALI								
POL30404	BLANC	POLYCARBONATE	31W	3000K 4000K 6500K	1300	4750Lm (4000K)	120°	90,00
POL30304	BLANC	POLYCARBONATE	43W	3000K 4000K 6500K	1600	6650Lm (4000K)	120°	100,00
ACCESSOIRES	COULEUR	MATIÈRE	DESCRIPTION			L(MM)	€	
POL306	ACIER INOXYDABLE	INOX	KIT DE SUSPENSION L:3000MM			3000		10,00
POL30504	BLANC	POLYCARBONATE	DETECTEUR PIR			76		40,00

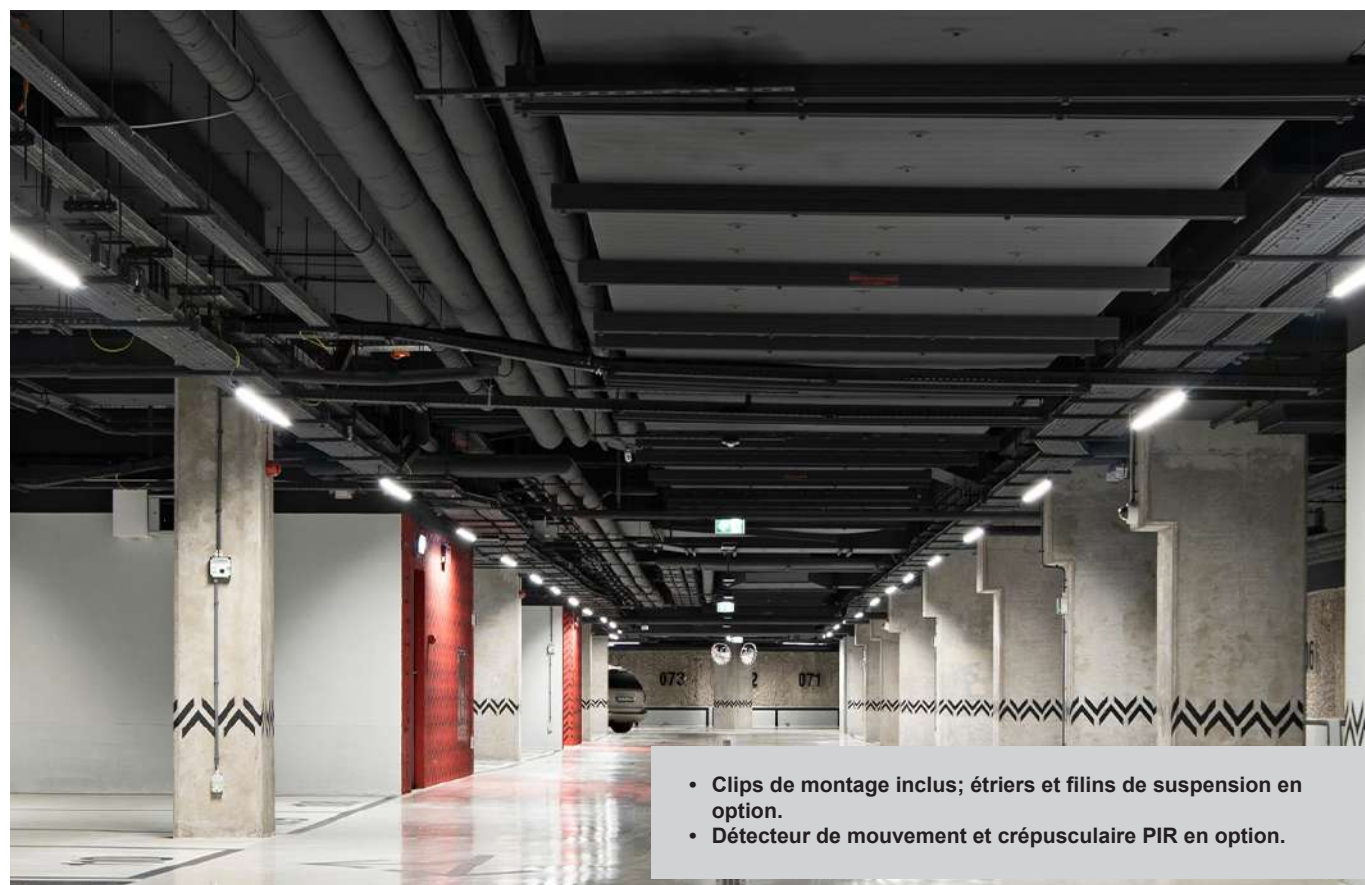

- Clips de montage inclus; étriers et fils de suspension en option.
- Détecteur de mouvement et crépusculaire PIR en option.



CAIMAN TUBULAR

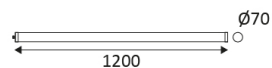
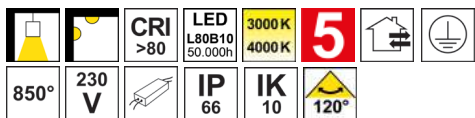

- Luminaire tubulaire étanche.
- Diffuseur en polycarbonate.
- CCT (3000K ou 4000K) et puissance (18, 22, 26 ou 30W) au choix via des interrupteurs dans le luminaire.
- Convertisseur non dimmable ou dimmable DALI intégré dans l'appareil.
- Livré avec 1.50m de câble.
- Anneaux de fixation anti-vandales inclus.
- Kit de suspension et détecteur hyperfréquence configurable (mouvement, crépusculaire et préavis d'extinction) disponibles séparément.



CAIMAN TUBULAR	COULEUR	MATIÈRE	P	CCT	L(MM)	LED LUMEN	SYSTEM LUMEN	α	€
NON DIMMABLE									
TUB4P NEW	BLANC	INOX 316 + POLYCARBONATE	18-22-26-30W	3000K 4000K	1200	5804Lm (4000K)	4980Lm (4000K)	120°	150,00
DIMMABLE DALI									
TUB4D NEW	BLANC	INOX 316 + POLYCARBONATE	18-22-26-30W	3000K 4000K	1200	5804Lm (4000K)	4980Lm (4000K)	120°	200,00

ACCESSOIRES	MATIÈRE	DESCRIPTION	L(MM)	€
TUBSUS3M NEW	ACIER	CAIMAN TUBULAR KIT DE SUSPENSION 3M	3000	35,00
TUBMWS NEW	PLASTIQUE	CAIMAN TUBULAR DÉTECTEUR HYPERFRÉQUENCE		35,00
TUBRCMWS NEW		TÉLÉCOMMANDE POUR LE DÉTECTEUR DU CAIMAN TUBULAR		15,00



CAIMAN VERSA

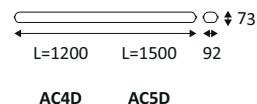

- Luminaire linéaire étanche anti-corrosion.
- Diffuseur en polycarbonate anti-UV.
- 3000K, 4000K ou 5700K au choix via un interrupteur dans le luminaire.
- Multi-puissance : 18 ou 37W (AC4) et 28 ou 56W (AC5) au choix via un interrupteur dans le luminaire.
- Convertisseur dimmable DALI-push intégré dans l'appareil.
- Entrées de câble à l'arrière et sur les côtés du luminaire.
- Clips de montage coulissants, étriers pour suspension et presse-étoupe inclus.

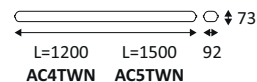
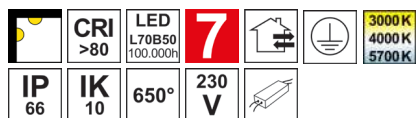

CAIMAN VERSA	COULEUR	MATIÈRE	P	CCT	L(MM)	LED LUMEN	SYSTEM LUMEN	α	€
AC4D	GRIS	POLYCARBONATE	18 - 37W	3000K 4000K 5700K	1200	3225 (18W 4000K) 6450 (37W 4000K)	2775 (18W 4000K) 5550 (37W 4000K)	120°	124,00
AC5D	GRIS	POLYCARBONATE	28 - 56W	3000K 4000K 5700K	1500	4850 (28W 4000K) 9700 (56W 4000K)	4200 (28W 4000K) 8400 (56W 4000K)	120°	150,00

CAIMAN QUICK CONNECT



- Luminaire linéaire étanche anti-corrosion.
- Diffuseur en polycarbonate anti-UV.
- 3000K, 4000K ou 5700K au choix via un interrupteur dans le luminaire.
- Multi-puissance : 18 ou 37W (AC4) et 28 ou 56W (AC5) au choix via un interrupteur dans le luminaire.
- Convertisseur non dimmable intégré dans l'appareil.
- Clips de montage coulissants et étriers pour suspension inclus.
- Avec câblage traversant et connexions rapides sans ouverture du luminaire.
- Kit Versabox à connexion rapide en option : détecteur hyperfréquence et commande à distance permettant de paramétrer le détecteur.

CAIMAN QUICK CONNECT	COULEUR	MATIÈRE	P	CCT	L(MM)	LED LUMEN	SYSTEM LUMEN	α	€
AC4TWN	GRIS	POLYCARBONATE	18 - 37W	3000K 4000K 5700K	1200	3225 (18W 4000K) 6450 (37W 4000K)	2775 (18W 4000K) 5550 (37W 4000K)	120°	57,00
AC5TWN	GRIS	POLYCARBONATE	28 - 56W	3000K 4000K 5700K	1500	4850 (28W 4000K) 9700 (56W 4000K)	4200 (28W 4000K) 8400 (56W 4000K)	120°	62,00

ACCESSOIRES	DESCRIPTION	€
ACKITMWS	KIT DETECTEUR HYPERFREQUENCE VERSABOX 	33,00
ACREMOTEMWS	COMMANDE A DISTANCE POUR DETECTEUR HF VERSABOX 	47,00

CAIMAN QUICK CONNECT



- Installation sans ouverture du luminaire grâce au câblage traversant et aux presse-étoupes Quick Connect.
- Détecteur en option.
- Multi-puissance et multi-CCT.



HIGH BAY

Guide comparatif des High-Bay

Quelle armature correspond à votre projet ?

Nos armatures sont idéales pour les zones de grandes hauteurs. Utilisez les diagrammes ci-dessous pour choisir le luminaire adapté. La hauteur dont vous disposez et le niveau d'éclairage souhaité (150 ou 200 Lux) vous permettent de déterminer la puissance et la largeur de faisceau du luminaire à sélectionner. Référez-vous aux hauteurs indiquées dans les schémas ci-dessous : chacune précise le diamètre d'éclairage obtenu et vous renseigne l'entraxe optimal entre les luminaires.

EAZY - Aires de stockage au sol (150 Lux)

Une seule référence offre trois niveaux de puissance. Le choix de l'angle du faisceau détermine la référence du luminaire adapté.

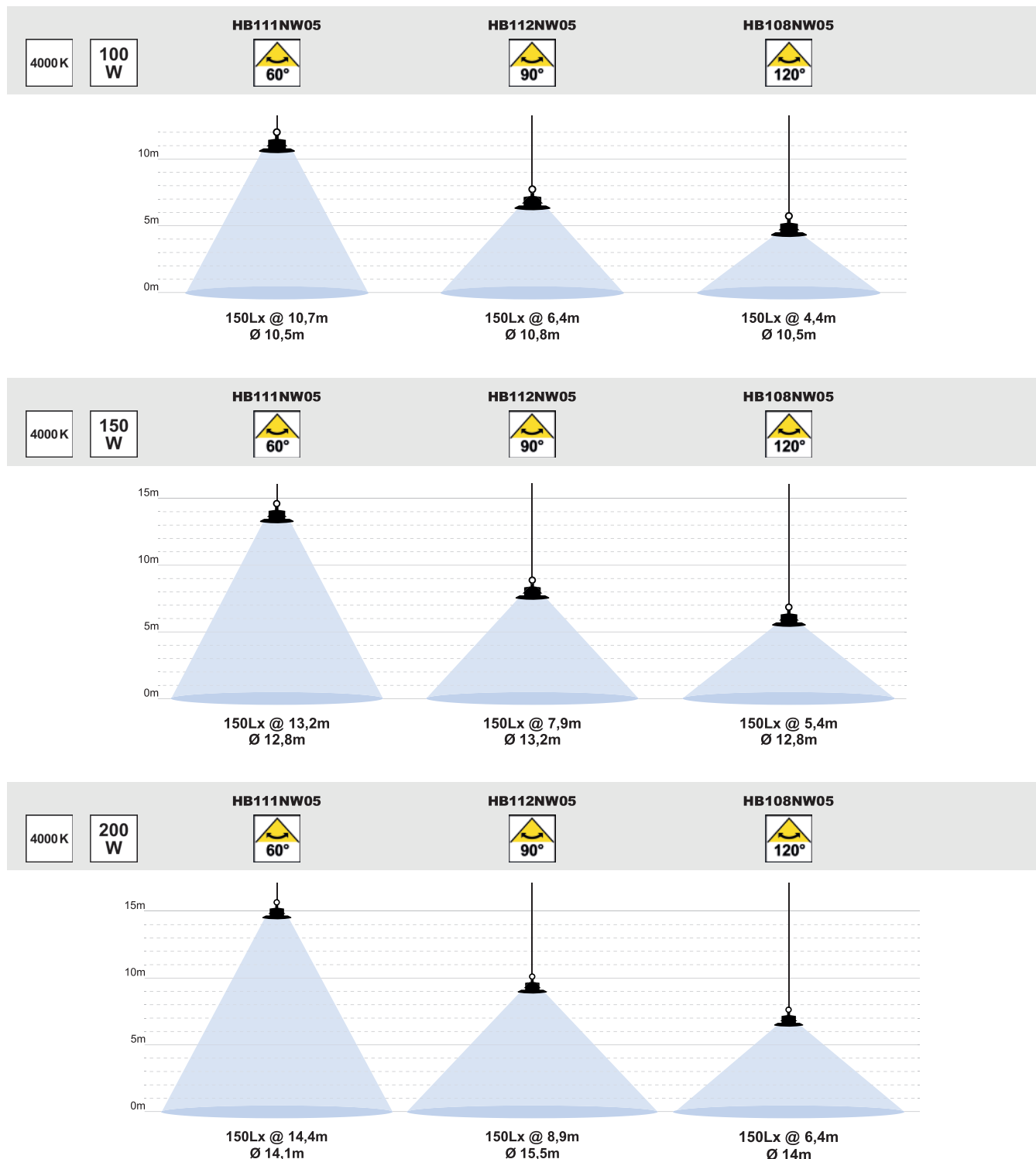



EAZY - Zones de stockages avec racks (200 Lux)

Une seule référence offre trois niveaux de puissance. Le choix de l'angle du faisceau détermine la référence du luminaire adapté.

4000K	100 W	HB111NW05 60°	HB112NW05 90°	HB108NW05 120°
-------	-------	------------------	------------------	-------------------

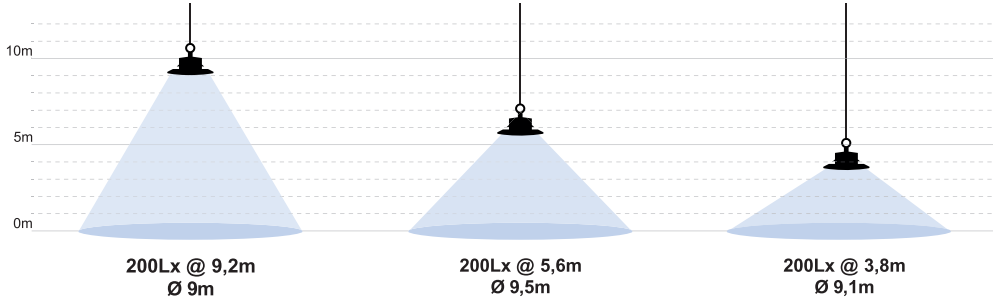

4000K	150 W	HB111NW05 60°	HB112NW05 90°	HB108NW05 120°
-------	-------	------------------	------------------	-------------------

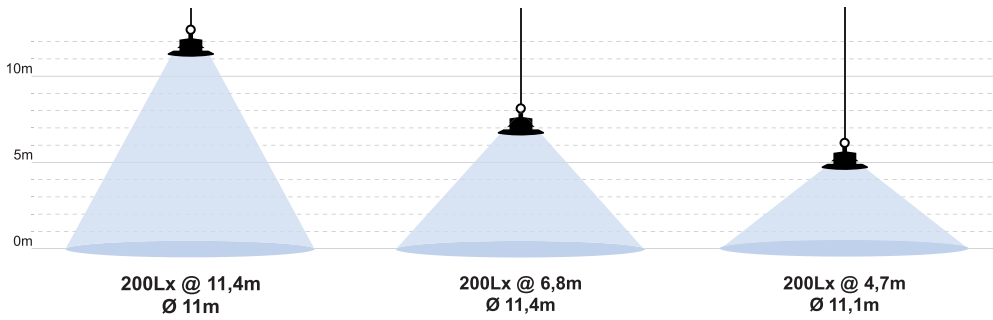

4000K	200 W	HB111NW05 60°	HB112NW05 90°	HB108NW05 120°
-------	-------	------------------	------------------	-------------------

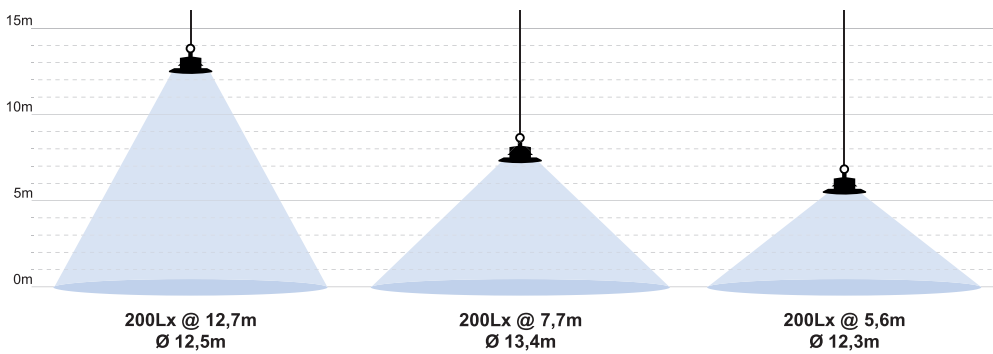

SPRINGBOK - Zones de stockages avec racks (150 Lux)

À l'aide du diagramme ci-dessous, sélectionnez la référence en fonction de la puissance nécessaire à l'éclairage souhaité.

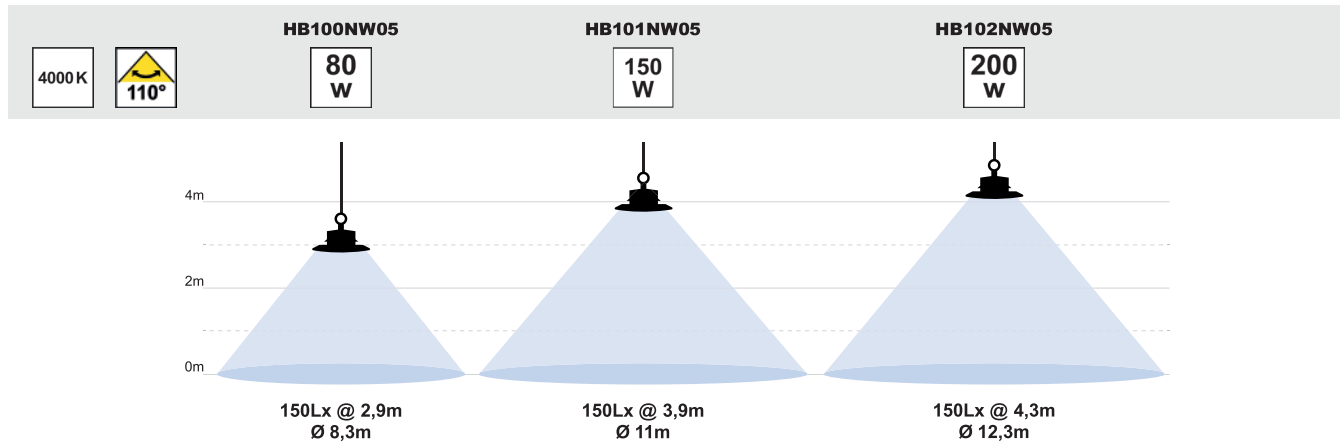

SPRINGBOK - Zones de stockages avec racks (200 Lux)

À l'aide du diagramme ci-dessous, sélectionnez la référence en fonction de la puissance nécessaire à l'éclairage souhaité.

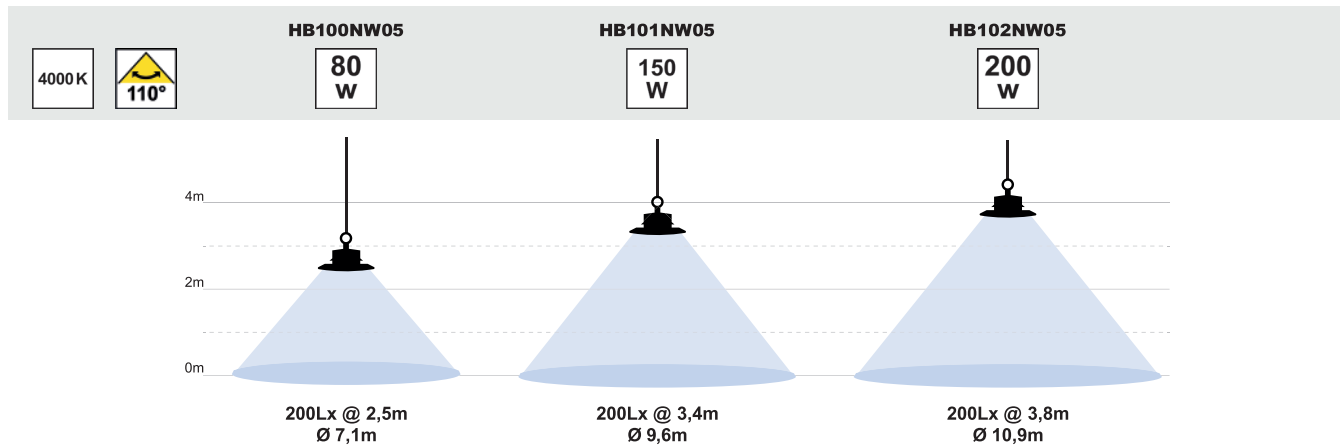



SPRINGBOK LITE 3

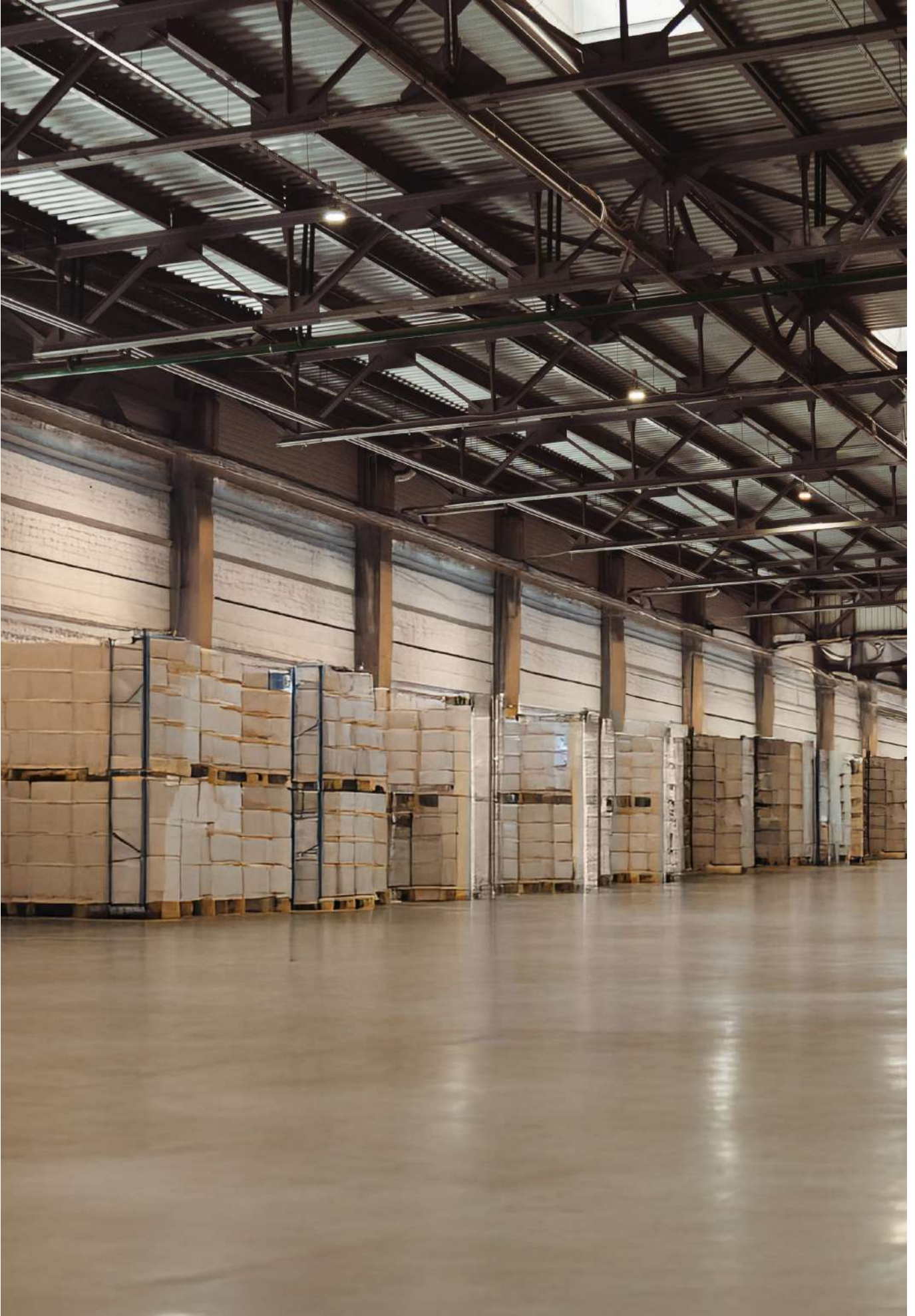

GENBAY 1



- Suspension industrielle économique pour un retour sur investissement rapide.
- Efficacité élevée de 135 lm/W.
- Kit de détection HF en option comprenant une boîte de raccordement et un contrepoids ; commande on/off avec temporisation et commutation en fonction de la lumière du jour (8-15 mètres max).
- Suspension industrielle ultra-mince et légère pour une manipulation aisée.
- Pré-câblé avec 1,0 m de H05RN-F 3x1,0 mm² Ø7 mm.
- Peut être suspendue par chaîne de levage, tige de suspension M10 ou câble tendu.

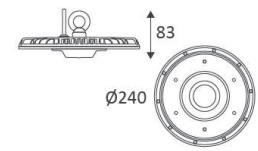

GENBAY 1	COULEUR	MATIÈRE	P	CCT	SYSTEM LUMEN	α	€
HBG1N40 NEW	GRIS MAT	ALUMINIUM	100W	4000K	13500Lm	110°	80,00

ACCESSOIRES	COULEUR	MATIÈRE	DESCRIPTION	€
HBGMWS NEW	NOIR	ACIER	GENBAY KIT DE DÉTECTION HF INCL. BOÎTE DE RACCORDEMENT ET CONTREPOIDS	15,00
HBGREF1015 NEW	BLANC MAT	PLASTIQUE	GENBAY RÉFRACTEUR UGR22 POUR 100/150W	50,00

GENBAY 2



- Suspension industrielle économique pour un retour sur investissement rapide.
- Efficacité élevée de 135 lm/W.
- Kit de détection HF en option comprenant une boîte de raccordement et un contrepoids ; commande on/off avec temporisation et commutation en fonction de la lumière du jour (8-15 mètres max).
- Suspension industrielle ultra-mince et légère pour une manipulation aisée.
- Pré-câblé avec 1,0 m de H05RN-F 3x1,0 mm² Ø7 mm.
- Peut être suspendue par chaîne de levage, tige de suspension M10 ou câble tendu.

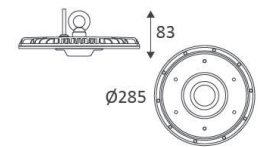

GENBAY 2	COULEUR	MATIÈRE	P	CCT	SYSTEM LUMEN	α	€
HBG2N40 NEW	GRIS MAT	ALUMINIUM	150W	4000K	19500Lm	110°	100,00

ACCESSOIRES	COULEUR	MATIÈRE	DESCRIPTION	€
HBGMWS NEW	NOIR	ACIER	GENBAY KIT DE DÉTECTION HF INCL. BOÎTE DE RACCORDEMENT ET CONTREPOIDS	15,00
HBGREF1520 NEW	BLANC MAT	PLASTIQUE	GENBAY RÉFRACTEUR UGR22 POUR 150/200W	65,00



GENBAY 3

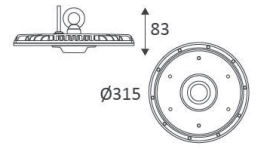

- Suspension industrielle économique pour un retour sur investissement rapide.
- Efficacité élevée de 135 lm/W.
- Kit de détection en option comprenant une boîte de raccordement et un contrepoids ; commande on/off avec temporisation et commutation en fonction de la lumière du jour (8-15 mètres max).
- Suspension industrielle ultra-mince et légère pour une manipulation aisée.
- Pré-câblé avec 1,0 m de H05RN-F 3x1,0 mm² Ø7 mm.
- Peut être suspendue par chaîne de levage, tige de suspension M10 ou câble tendu.



GENBAY 3	COULEUR	MATIÈRE	P	CCT	SYSTEM LUMEN	α	€
HBG3N40 NEW	GRIS MAT	ALUMINIUM	200W	4000K	26000Lm	110°	120,00

ACCESSOIRES	COULEUR	MATIÈRE	DESCRIPTION	€
HBMWS NEW	NOIR	ACIER	GENBAY KIT DE DÉTECTION HF INCL. BOÎTE DE RACCORDEMENT ET CONTREPOIDS	15,00
HGBREF1520 NEW	BLANC MAT	PLASTIQUE	GENBAY RÉFRACTEUR UGR22 POUR 150/200W	65,00

GENBAY 1

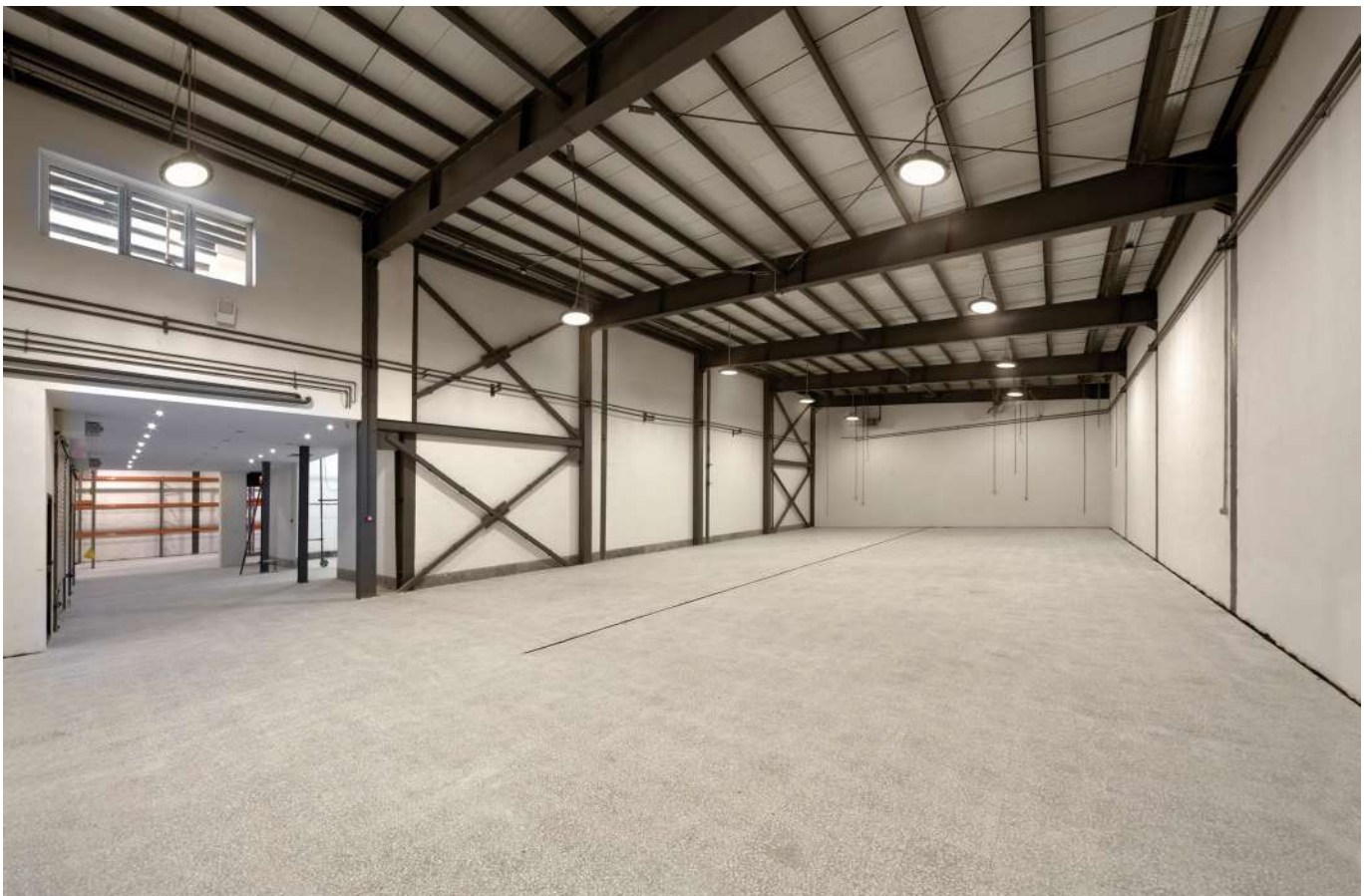

SPRINGBOK LITE 1



- Suspension industrielle pour grandes hauteurs.
- Diffuseur en verre trempé.
- Câble d'alimentation H05RN-F noir 1.50m et boucle de suspension M10 inclus.
- Convertisseur non dimmable intégré dans l'appareil.
- Installation possible jusqu'à une hauteur de 15m.
- Accessoires en option : étrier de fixation réglable 270°, réflecteur prismatique 80°, détecteur hyperfréquence et commande à distance permettant de paramétrer le(s) détecteur(s).
- Réglages par défaut du détecteur hyperfréquence : durée d'allumage 5 sec., capteur de luminosité désactivé, zone de détection 100%.
- La commande à distance est nécessaire pour paramétrer d'autres réglages.

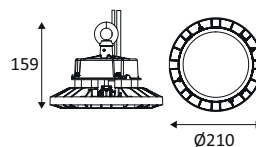

SPRINGBOK LITE 1	COULEUR	MATIÈRE	P	CCT	LED LUMEN	SYSTEM LUMEN	α	€
HB100WW05	■ NOIR	FONTE D'ALUMINIUM	80W	3000K	12350Lm	10185Lm	110°	133,00
HB100NW05	■ NOIR	FONTE D'ALUMINIUM	80W	4000K	13150Lm	10545Lm	110°	133,00
ACCESSOIRES	COULEUR	MATIÈRE	DESCRIPTION					€
HB104	NOIR		ETRIER DE FIXATION REGLABLE 270°					24,00
HB103	NOIR		KIT DETECTEUR HYPERFREQUENCE IP65					146,00
HB115			COMMANDE A DISTANCE POUR DETECTEUR HF					92,00
HB105		POLYCARBONATE	REFLECTEUR 80° PC PRISMATIQUE 309X160MM					54,00

SPRINGBOK LITE 2



- Suspension industrielle pour grandes hauteurs.
- Diffuseur en verre trempé.
- Câble d'alimentation H05RN-F noir 1.50m et boucle de suspension M10 inclus.
- Convertisseur non dimmable intégré dans l'appareil.
- Installation possible jusqu'à une hauteur de 15m.
- Accessoires en option : étrier de fixation réglable 270°, réflecteur prismatique 80°, détecteur hyperfréquence et commande à distance permettant de paramétrer le(s) détecteur(s).
- Réglages par défaut du détecteur hyperfréquence : durée d'allumage 5 sec., capteur de luminosité désactivé, zone de détection 100%.
- La commande à distance est nécessaire pour paramétrer d'autres réglages.

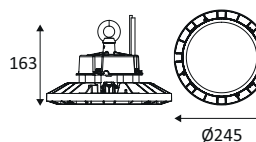

SPRINGBOK LITE 2	COULEUR	MATIÈRE	P	CCT	LED LUMEN	SYSTEM LUMEN	α	€
HB101WW05	■ NOIR	FONTE D'ALUMINIUM	150W	3000K	22150Lm	19130Lm	110°	159,00
HB101NW05	■ NOIR	FONTE D'ALUMINIUM	150W	4000K	23550Lm	19525Lm	110°	159,00
ACCESSOIRES	COULEUR	MATIÈRE	DESCRIPTION					€
HB104	NOIR		ETRIER DE FIXATION REGLABLE 270°					24,00
HB103	NOIR		KIT DETECTEUR HYPERFREQUENCE IP65					146,00
HB115			COMMANDE A DISTANCE POUR DETECTEUR HF					92,00
HB106		POLYCARBONATE	REFLECTEUR 80° PC PRISMATIQUE 413X250MM					81,00



SPRINGBOK LITE 3

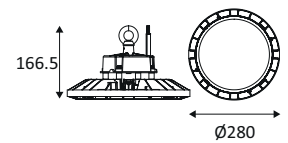

- Suspension industrielle pour grandes hauteurs.
- Diffuseur en verre trempé.
- Câble d'alimentation H05RN-F noir 1.50m et boucle de suspension M10 inclus.
- Convertisseur non dimmable intégré dans l'appareil.
- Installation possible jusqu'à une hauteur de 15m.
- Accessoires en option : étrier de fixation réglable 270°, réflecteur prismatique 80°, détecteur hyperfréquence et commande à distance permettant de paramétrer le(s) détecteur(s).
- Réglages par défaut du détecteur hyperfréquence : durée d'allumage 5 sec., capteur de luminosité désactivé, zone de détection 100%.
- La commande à distance est nécessaire pour paramétrer d'autres réglages.

SPRINGBOK LITE 3	COULEUR	MATIÈRE	P	CCT	LED LUMEN	SYSTEM LUMEN	α	€
HB102WW05	NOIR	FONTE D'ALUMINIUM	200W	3000K	29200Lm	25195Lm	110°	184,00
HB102NW05	NOIR	FONTE D'ALUMINIUM	200W	4000K	31050Lm	25715Lm	110°	184,00
ACCESSOIRES	COULEUR	MATIÈRE	DESCRIPTION					€
HB104	NOIR		ETRIER DE FIXATION REGLABLE 270°					24,00
HB103	NOIR		KIT DETECTEUR HYPERFREQUENCE IP65					146,00
HB115			COMMANDE A DISTANCE POUR DETECTEUR HF					92,00
HB107		POLYCARBONATE	REFLECTEUR 80° PC PRISMATIQUE 413X230MM					86,00

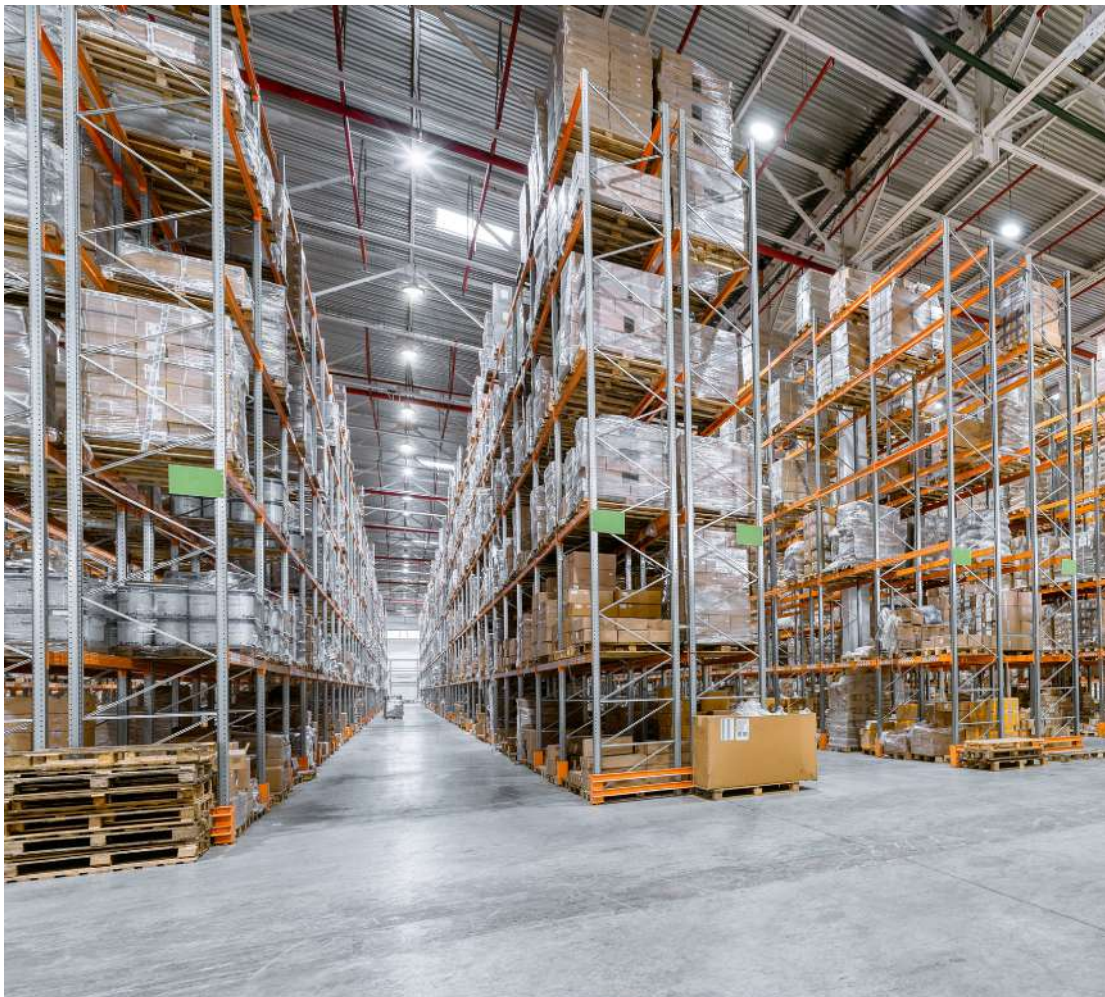

EAZY





EAZY

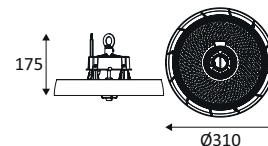
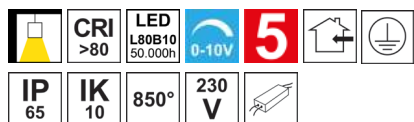

- Suspension industrielle pour grandes hauteurs.
- Diffuseur en polycarbonate.
- Câble d'alimentation H05RN-F noir 1.50m, câble pour variation 0.20m et boucle de suspension M10 inclus.
- Multi-puissance : 100, 150 ou 200W au choix via un interrupteur à l'arrière du luminaire.
- Convertisseur dimmable 0-10V intégré dans l'appareil.
- Installation possible jusqu'à une hauteur de 15m.
- Accessoires en option : étrier de fixation réglable 270°, grille de protection, réflecteur polycarbonate, détecteur hyperfréquence et commande à distance permettant de paramétrer le(s) détecteur(s). L'utilisation du détecteur hyperfréquence n'est pas possible si un variateur 0-10V est raccordé au produit.
- Réglages par défaut du détecteur hyperfréquence : durée d'allumage 10 min., capteur de luminosité 50 Lux, zone de détection 100%, gradation du mode veille 30%, période de veille continue.
- La commande à distance est nécessaire pour paramétrer d'autres réglages.

EAZY	COULEUR	MATIÈRE	P	CCT	LED LUMEN	SYSTEM LUMEN	α	€
HB111WW05	NOIR	FONTE D'ALUMINIUM	100 - 150 - 200W	3000K	19850 (100W) 28900 (150W) 36700 (200W)	15900Lm 22780Lm 29275Lm	60°	211,00
HB111NW05	NOIR	FONTE D'ALUMINIUM	100 - 150 - 200W	4000K	20850 (100W) 30450 (150W) 38650 (200W)	16710Lm 23980Lm 30870Lm	60°	211,00
HB112WW05	NOIR	FONTE D'ALUMINIUM	100 - 150 - 200W	3000K	19850 (100W) 28900 (150W) 36700 (200W)	16395Lm 23535Lm 30275Lm	90°	211,00
HB112NW05	NOIR	FONTE D'ALUMINIUM	100 - 150 - 200W	4000K	20850 (100W) 30450 (150W) 38650 (200W)	17205Lm 24730Lm 31885Lm	90°	211,00
HB108WW05	NOIR	FONTE D'ALUMINIUM	100 - 150 - 200W	3000K	19850 (100W) 28900 (150W) 36700 (200W)	15335Lm 21960Lm 30320Lm	120°	211,00
HB108NW05	NOIR	FONTE D'ALUMINIUM	100 - 150 - 200W	4000K	20850 (100W) 30450 (150W) 38650 (200W)	16920Lm 24480Lm 32075Lm	120°	211,00

ACCESSOIRES	COULEUR	DESCRIPTION	€
HB104	NOIR	ETRIER DE FIXATION REGLABLE 270°	24,00
HB110	BLANC	GRILLE DE PROTECTION	45,00
HB114	NOIR	DETECTEUR HYPERFREQUENCE IP65	61,00
HB115		COMMANDE A DISTANCE POUR DETECTEUR HF	92,00
HB113		REFLECTEUR POLYCARBONATE 412X151MM	63,00

LUMINAIRES EXTÉRIEURS





ENCASTRÉS DE SOL	362
SPOTS SUR PIQUETS	384
BORNES	404
ENCASTRÉS MURAUX	424
APPLIQUES	428
PLAFONNIERS	464
PROJECTEURS	476
SPOTS	494
SOLAIRES	500

ENCASTRÉS DE SOL

KO2000 R GU10

- Encastré de sol rond.
- Boîtier d'encastrement fourni.
- Système de relamping simple et rapide.
- Carrossable résistance 1000kg.
- Double presse-étoupe.



KO2000 R GU10	COULEUR	MATIÈRE	DOUILLE	LAMPE	WATT MAX	€	
KO2000R		ACIER INOXYDABLE	INOX 304	GU10	PAR16 LED	10W	80,00
KO2000R16		ACIER INOXYDABLE	INOX 316	GU10	PAR16 LED	10W	105,00

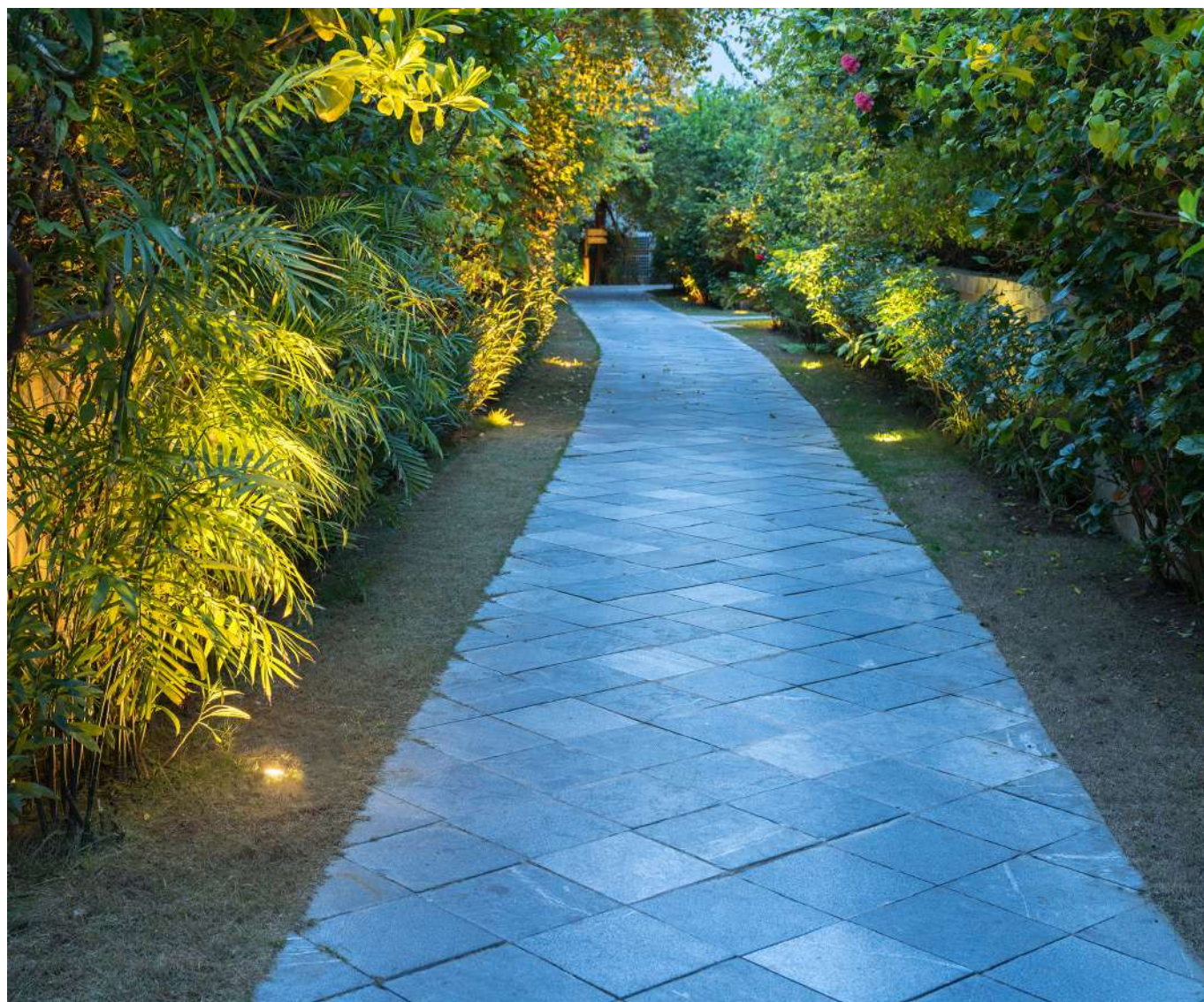



GL018 C

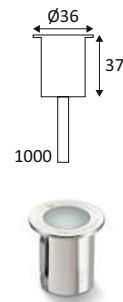

- Encastré de sol rond.
- Diffuseur en verre dépoli.
- 1m de câble H05RN-F fourni (diamètre 6mm).
- Immergeable jusqu'à 9m de profondeur.
- Convertisseur 24Vdc à commander séparément.
- Boîte de raccordement étanche à commander séparément.

GL018 C	COULEUR	MATIÈRE	P	CCT	LED LUMEN	SYSTEM LUMEN	α	€
GL018CWW	■ ACIER INOXYDABLE	INOX 316	0,4W	3000K	30Lm	4Lm	120°	78,00

ACCESSOIRES	DESCRIPTION	L(MM)	€
JB1	BOITE DE RACCORDEMENT PARALLELE 3 SORTIES IP68	95	12,00
JB5	BOITE DE CONNEXION PARALLELE AVEC GEL IP68	93,5	51,00
JB6	CONNECTEUR AVEC GEL IP68	40	31,00

CONVERTISSEURS ET SOURCES	WATT MAX	€
5783 DRIVER 75W 24V CV IP67	75W	65,00
5784 DRIVER 100W 24V CV IP67	100W	110,00
5672 DRIVER 150W 24V CV IP67	150W	135,00
5947 DRIVER 240W 24V CV IP67	240W	270,00



GL019 II



- Encastré de sol rond.
- Diffuseur en verre clair.
- Inox 316 pour les zones côtières.
- Tube d'encastrement et 1m de câble H05RN-F fourni (diamètre 6mm).
- Convertisseur 150 à 700mA à commander séparément.
- Boîte de raccordement étanche à commander séparément.

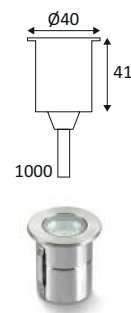

GL019 II	COULEUR	MATIÈRE	P	CCT	LED LUMEN	SYSTEM LUMEN	α	€	
GL019RSS27S NEW		ACIER INOXYDABLE	INOX 316	0,4 - 2,2W	2700K	290Lm	196Lm	12°	123,00
GL019RSS27F NEW		ACIER INOXYDABLE	INOX 316	0,4 - 2,2W	2700K	290Lm	196Lm	38°	123,00
GL019RSS30S NEW		ACIER INOXYDABLE	INOX 316	0,4 - 2,2W	3000K	290Lm	210Lm	12°	123,00
GL019RSS30F NEW		ACIER INOXYDABLE	INOX 316	0,4 - 2,2W	3000K	290Lm	210Lm	38°	123,00

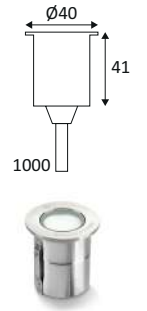

ACCESSOIRES	DESCRIPTION	L(MM)	€
JB2	BOITE DE RACCORDEMENT SERIE 3 SORTIES IP68	95	12,00
JB4	BOITE DE CONNEXION SERIE AVEC GEL IP68	93,5	51,00
JB6	CONNECTEUR AVEC GEL IP68	40	31,00

CONVERTISSEURS ET SOURCES	WATT MAX	€
PSIP3509W DRIVER 1-9W 350MA CC IP65	1-9W	49,00
PSIP35018W DRIVER 9-18W 350MA CC IP65	9-18W	65,00
PSIP70018W DRIVER 2-18W 700MA CC IP65	2-18W	65,00
PSIP70036W DRIVER 18-36W 700MA CC IP65	18-36W	83,00
DRV150700 DRIVER 6-30W 150-250-350-500-700MA CC	6-30W	46,00
DRV350700TD DRIVER 14-20W 350-500-700MA CC DIM	14-20W	72,00

**GL019 F II**

- Encastré de sol rond.
- Diffuseur en verre opalin.
- Inox 316 pour les zones côtières.
- Tube d'encastrement et 1m de câble H05RN-F fourni (diamètre 6mm).
- Convertisseur 150 à 350mA à commander séparément.
- Boîte de raccordement à commander séparément.

GL019 F II	COULEUR	MATIÈRE	P	CCT	LED LUMEN	SYSTEM LUMEN	α	€	
GL019SSFD27 NEW	■	ACIER INOXYDABLE	INOX 316	0,4 - 1 W	2700K	184Lm	32Lm	38°	123,00
GL019SSFD30 NEW	■	ACIER INOXYDABLE	INOX 316	0,4 - 1 W	3000K	184Lm	30Lm	38°	123,00

ACCESSOIRES	DESCRIPTION	L(MM)	€
JB2	BOITE DE RACCORDEMENT SERIE 3 SORTIES IP68	95	 12,00
JB4	BOITE DE CONNEXION SERIE AVEC GEL IP68	93,5	 51,00
JB6	CONNECTEUR AVEC GEL IP68	40	 31,00

CONVERTISSEURS ET SOURCES	WATT MAX	€
PSIP3509W DRIVER 1-9W 350MA CC IP65 	1-9W	49,00
PSIP35018W DRIVER 9-18W 350MA CC IP65 	9-18W	65,00
DRV150700 DRIVER 6-30W 150-250-350-500-700MA CC 	6-30W	46,00
DRV350700TD DRIVER 14-20W 350-500-700MA CC DIM 	14-20W	72,00

GL019 LG II



- Encastré de sol rond.
- Basse luminance, avec grille nid d'abeille.
- Inox 316 pour les zones côtières.
- Tube d'encastrement et 1m de câble H05RN-F fourni (diamètre 6mm).
- Convertisseur 150 à 700mA à commander séparément.
- Boîte de raccordement étanche à commander séparément.

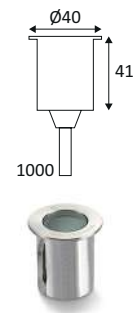

GL019 LG II	COULEUR	MATIÈRE	P	CCT	LED LUMEN	SYSTEM LUMEN	α	€	
GL019SSLG27F NEW	■	ACIER INOXYDABLE	INOX 316	0,4 - 2,2W	2700K	290Lm	120Lm	38°	133,00
GL019SSLG30F NEW	■	ACIER INOXYDABLE	INOX 316	0,4 - 2,2W	3000K	290Lm	128Lm	38°	133,00

ACCESSOIRES	DESCRIPTION	L(MM)	€
JB2	BOITE DE RACCORDEMENT SERIE 3 SORTIES IP68	95	12,00
JB4	BOITE DE CONNEXION SERIE AVEC GEL IP68	93,5	51,00
JB6	CONNECTEUR AVEC GEL IP68	40	31,00

CONVERTISSEURS ET SOURCES	WATT MAX	€
PSIP3509W DRIVER 1-9W 350MA CC IP65	1-9W	49,00
PSIP35018W DRIVER 9-18W 350MA CC IP65	9-18W	65,00
PSIP70018W DRIVER 2-18W 700MA CC IP65	2-18W	65,00
PSIP70036W DRIVER 18-36W 700MA CC IP65	18-36W	83,00
DRV150700 DRIVER 6-30W 150-250-350-500-700MA CC	6-30W	46,00
DRV350700TD DRIVER 14-20W 350-500-700MA CC DIM	14-20W	72,00



GL019 ULG II

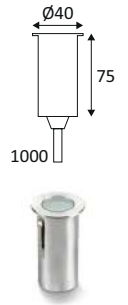

- Encastré de sol rond.
- Très basse luminance.
- Inox 316 pour les zones côtières.
- Tube d'encastrement et 1m de câble H05RN-F fourni (diamètre 6mm).
- Convertisseur 150 à 350mA à commander séparément.
- Boîte de raccordement étanche à commander séparément.

GL019 ULG II	COULEUR	MATIÈRE	P	CCT	LED LUMEN	SYSTEM LUMEN	α	€
GL019USS27F NEW	ACIER INOXYDABLE	INOX 316	0,4 - 1 W	2700K	290Lm	77Lm	36°	163,00
GL019USS30F NEW	ACIER INOXYDABLE	INOX 316	0,4 - 1 W	3000K	290Lm	82Lm	36°	163,00

ACCESSOIRES	DESCRIPTION	L(MM)	€
JB2	BOITE DE RACCORDEMENT SERIE 3 SORTIES IP68	95	12,00
JB4	BOITE DE CONNEXION SERIE AVEC GEL IP68	93,5	51,00
JB6	CONNECTEUR AVEC GEL IP68	40	31,00

CONVERTISSEURS ET SOURCES	WATT MAX	€
PSIP3509W DRIVER 1-9W 350MA CC IP65	1-9W	49,00
PSIP35018W DRIVER 9-18W 350MA CC IP65	9-18W	65,00
DRV150700 DRIVER 6-30W 150-250-350-500-700MA CC	6-30W	46,00
DRV350700TD DRIVER 14-20W 350-500-700MA CC DIM	14-20W	72,00

SWIM



- Encastré de sol rond.
- Boîtier d'encastrement et 0.35m de câble fournis.
- Convertisseur 24Vdc à commander séparément.



SWIM	COULEUR	MATIÈRE	P	CCT	LED LUMEN	SYSTEM LUMEN	α	€
OU486WW16	ACIER INOXYDABLE	INOX 316	5W	3000K	195Lm	125Lm	24°	81,00

CONVERTISSEURS ET SOURCES	WATT MAX	€
5783 DRIVER 75W 24V CV IP67	75W	90,00
5784 DRIVER 100W 24V CV IP67	100W	120,00
5672 DRIVER 150W 24V CV IP67	150W	120,00
5947 DRIVER 240W 24V CV IP67	240W	280,00





WALLY A



- Encastré de sol rond.
- Wall washer.
- Boîtier d'encastrement et 0.35m de câble fournis.
- Convertisseur 24Vdc à commander séparément.

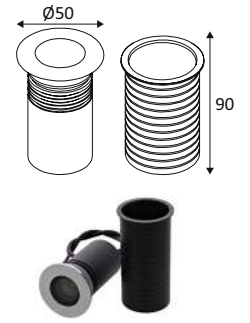

WALLY A	COULEUR	MATIÈRE	P	CCT	LED LUMEN	SYSTEM LUMEN	€
OU488WW16	ACIER INOXYDABLE	INOX 316	5W	3000K	195Lm	100Lm	89,00

CONVERTISSEURS ET SOURCES			WATT MAX	€
5783	DRIVER 75W 24V CV IP67		75W	90,00
5784	DRIVER 100W 24V CV IP67		100W	120,00
5672	DRIVER 150W 24V CV IP67		150W	120,00
5947	DRIVER 240W 24V CV IP67		240W	280,00



GL016 II

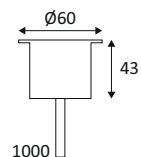
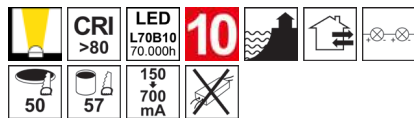

- Encastré de sol rond.
- Diffuseur en verre clair.
- Inox 316 pour les zones côtières.
- Tube d'encastrement et 1m de câble H05RN-F fourni (diamètre 6mm).
- Convertisseur 150 à 700mA à commander séparément.
- Boîte de raccordement étanche à commander séparément.



GL016 II	COULEUR	MATIÈRE	P	CCT	LED LUMEN	SYSTEM LUMEN	α	€
GL016RSS27F NEW		ACIER INOXYDABLE	0,4W - 2,2W	2700K	290Lm	196Lm	40°	133,00
GL016RSS30F NEW		ACIER INOXYDABLE	0,4 - 2,2W	3000K	290Lm	210Lm	40°	133,00

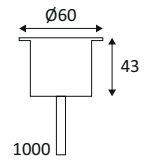
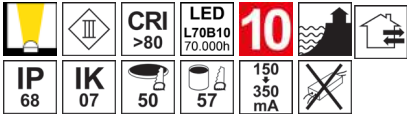

ACCESSOIRES	DESCRIPTION	L(MM)	€
JB2	BOITE DE RACCORDEMENT SERIE 3 SORTIES IP68	95	12,00
JB4	BOITE DE CONNEXION SERIE AVEC GEL IP68	93,5	51,00
JB6	CONNECTEUR AVEC GEL IP68	40	31,00
WCR275BLACK	CABLE H05RN-F 2X0,75MM² 1M	1000	8,00

CONVERTISSEURS ET SOURCES	WATT MAX	€
PSIP3509W DRIVER 1-9W 350MA CC IP65	1-9W	49,00
PSIP35018W DRIVER 9-18W 350MA CC IP65	9-18W	65,00
PSIP70018W DRIVER 2-18W 700MA CC IP65	2-18W	65,00
PSIP70036W DRIVER 18-36W 700MA CC IP65	18-36W	83,00
DRV150700 DRIVER 6-30W 150-250-350-500-700MA CC	6-30W	46,00
DRV350700TD DRIVER 14-20W 350-500-700MA CC DIM	14-20W	72,00

**GL016 F II**

- Encastré de sol rond.
- Diffuseur en verre opalin.
- Inox 316 pour les zones côtières.
- Tube d'encastrement et 1m de câble H05RN-F fourni (diamètre 6mm).
- Convertisseur 150 à 350mA à commander séparément.
- Boîte de raccordement à commander séparément.

GL016 F II	COULEUR	MATIÈRE	LED	CCT	LED LUMEN	SYSTEM LUMEN	α	€	
GL016SSFD27 NEW	■	ACIER INOXYDABLE	INOX 316	0,4W - 1W	2700K	184Lm	32Lm (350mA)	40°	133,00
GL016SSFD30 NEW	■	ACIER INOXYDABLE	INOX 316	0,4 - 1 W	3000K	184Lm	32Lm	40°	133,00

ACCESSOIRES	DESCRIPTION	L(MM)	€
JB2	BOITE DE RACCORDEMENT SERIE 3 SORTIES IP68	95	 12,00
JB4	BOITE DE CONNEXION SERIE AVEC GEL IP68	93,5	 51,00
JB6	CONNECTEUR AVEC GEL IP68	40	 31,00
WCR275BLACK	CABLE H05RN-F 2X0,75MM² 1M	1000	 8,00

CONVERTISSEURS ET SOURCES	WATT MAX	€
PSIP3509W DRIVER 1-9W 350MA CC IP65 	1-9W	49,00
PSIP35018W DRIVER 9-18W 350MA CC IP65 	9-18W	65,00
DRV150700 DRIVER 6-30W 150-250-350-500-700MA CC 	6-30W	46,00
DRV350700TD DRIVER 14-20W 350-500-700MA CC DIM 	14-20W	72,00

GL040 II



- Encastré de sol rond.
- Diffuseur en verre clair.
- Inox 316 pour les zones côtières.
- Tube d'encastrement et 1m de câble H05RN-F fourni (diamètre 6mm).
- Convertisseur 150 à 700mA à commander séparément.
- Boîte de raccordement étanche à commander séparément.

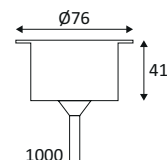

GL040 II	COULEUR	MATIÈRE	P	CCT	LED LUMEN	SYSTEM LUMEN	α	€	
GL040RSS27S NEW		ACIER INOXYDABLE	INOX 316	0,8 - 4,6W	2700K	620Lm	515Lm	12°	255,00
GL040RSS27F NEW		ACIER INOXYDABLE	INOX 316	0,8 - 4,6W	2700K	620Lm	515Lm	40°	255,00
GL040RSS30S NEW		ACIER INOXYDABLE	INOX 316	0,8 - 4,6W	3000K	620Lm	520Lm	12°	255,00
GL040RSS30F NEW		ACIER INOXYDABLE	INOX 316	0,8 - 4,6W	3000K	620Lm	520Lm	40°	255,00

ACCESSOIRES	DESCRIPTION	L(MM)	€
JB2	BOITE DE RACCORDEMENT SERIE 3 SORTIES IP68	95	12,00
JB4	BOITE DE CONNEXION SERIE AVEC GEL IP68	93,5	51,00
JB6	CONNECTEUR AVEC GEL IP68	40	31,00

CONVERTISSEURS ET SOURCES	WATT MAX	€
PSIP3509W DRIVER 1-9W 350MA CC IP65	1-9W	49,00
PSIP35018W DRIVER 9-18W 350MA CC IP65	9-18W	65,00
PSIP70018W DRIVER 2-18W 700MA CC IP65	2-18W	65,00
PSIP70036W DRIVER 18-36W 700MA CC IP65	18-36W	83,00
DRV150700 DRIVER 6-30W 150-250-350-500-700MA CC	6-30W	46,00
DRV350700TD DRIVER 14-20W 350-500-700MA CC DIM	14-20W	72,00

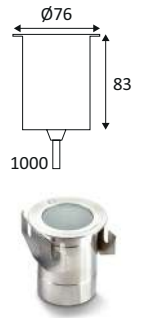
**GL040 ULG II**

- Encastré de sol rond.
- Très basse luminance.
- Inox 316 pour les zones côtières.
- Tube d'encastrement et 1m de câble H05RN-F fourni (diamètre 6mm).
- Convertisseur 150 à 500mA à commander séparément.
- Boîte de raccordement étanche à commander séparément.

GL040 ULG II	COULEUR	MATIÈRE	P	CCT	LED LUMEN	SYSTEM LUMEN	α	€
GL040USS27F NEW	ACIER INOXYDABLE	INOX 316	0,8 - 3 W	2700K	620Lm	284Lm	36°	305,00
GL040USS30F NEW	ACIER INOXYDABLE	INOX 316	0,8 - 3 W	3000K	620Lm	286Lm	36°	305,00

ACCESSOIRES	DESCRIPTION	L(MM)	€
JB2	BOITE DE RACCORDEMENT SERIE 3 SORTIES IP68	95	12,00
JB4	BOITE DE CONNEXION SERIE AVEC GEL IP68	93,5	51,00
JB6	CONNECTEUR AVEC GEL IP68	40	31,00

CONVERTISSEURS ET SOURCES	WATT MAX	€
PSIP3509W DRIVER 1-9W 350MA CC IP65	1-9W	49,00
PSIP35018W DRIVER 9-18W 350MA CC IP65	9-18W	65,00
DRV150700 DRIVER 6-30W 150-250-350-500-700MA CC	6-30W	46,00
DRV350700TD DRIVER 14-20W 350-500-700MA CC DIM	14-20W	72,00

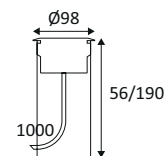
GL038 II

- Encastré de sol rond.
- Diffuseur en verre clair.
- Inox 316 pour les zones côtières.
- Pot d'encastrement et 1m de câble H05RN-F (diamètre 6mm) fournis.
- Convertisseur non dimmable intégré dans l'appareil.
- Boîte de connexion étanche à commander séparément.

GL038 II	COULEUR	MATIÈRE	P	CCT	LED LUMEN	SYSTEM LUMEN	α	€	
GL038SS27MF NEW	■	ACIER INOXYDABLE	INOX 316	2,8W	2700K	620Lm	297Lm	40°	360,00
GL038SS30MF NEW	■	ACIER INOXYDABLE	INOX 316	2,8W	3000K	620Lm	300Lm	40°	360,00

ACCESSOIRES	DESCRIPTION	L(MM)	€
JB5	BOITE DE CONNEXION PARALLELE AVEC GEL IP68	93,5	51,00
WC59	CONNECTEUR IP68	125	77,00





APA RD-230



- Encastré de sol rond.
- Carrossable résistance 1500kg.
- Avec grille nid d'abeille amovible.
- Boîtier d'encastrement et 1.00m de câble fournis.
- Dimmable.

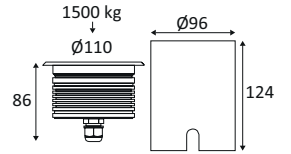

APA RD-230	COULEUR	MATIÈRE	P	CCT	LED LUMEN	SYSTEM LUMEN	α	€
OU326WW16	■ ACIER INOXYDABLE	INOX 316	8W	3000K	550Lm	350Lm	60°	165,00
OU326NW16	■ ACIER INOXYDABLE	INOX 316	8W	4000K	600Lm	405Lm	60°	165,00

BIG APA RD-230



- Encastré de sol rond.
- Carrossable résistance 1500kg.
- Avec grille nid d'abeille amovible.
- Boîtier d'encastrement et 1.00m de câble fournis.
- Dimmable.

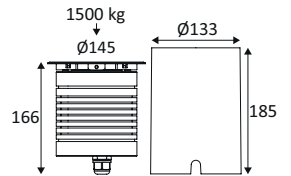

BIG APA RD-230	COULEUR	MATIÈRE	P	CCT	LED LUMEN	SYSTEM LUMEN	α	€
OU411WW16	■ ACIER INOXYDABLE	INOX 316	20W	3000K	1860Lm	1435Lm	60°	260,00
OU411NW16	■ ACIER INOXYDABLE	INOX 316	20W	4000K	1940Lm	1535Lm	60°	260,00



GYRO



- Encastré de sol rond.
- Boîtier d'encastrement et 1.00m de câble fournis.
- Convertisseur non dimmable intégré dans l'appareil.

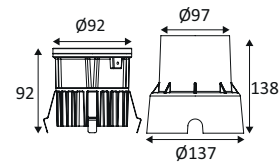

GYRO	COULEUR	MATIÈRE	P	CCT	LED LUMEN	SYSTEM LUMEN	α	€
OU425WW05	■ NOIR	VERRE	6W	3000K	500Lm	450Lm	20°	185,00

GYRO A



- Encastré de sol rond.
- Wall washer.
- Boîtier d'encastrement et 1.00m de câble fournis.
- Convertisseur non dimmable intégré dans l'appareil.

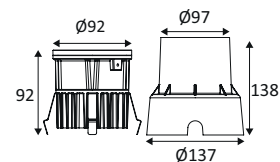

GYRO A	COULEUR	MATIÈRE	P	CCT	LED LUMEN	SYSTEM LUMEN	€
OU426WW05	■ NOIR	VERRE	8W	3000K	500Lm	155Lm	181,00

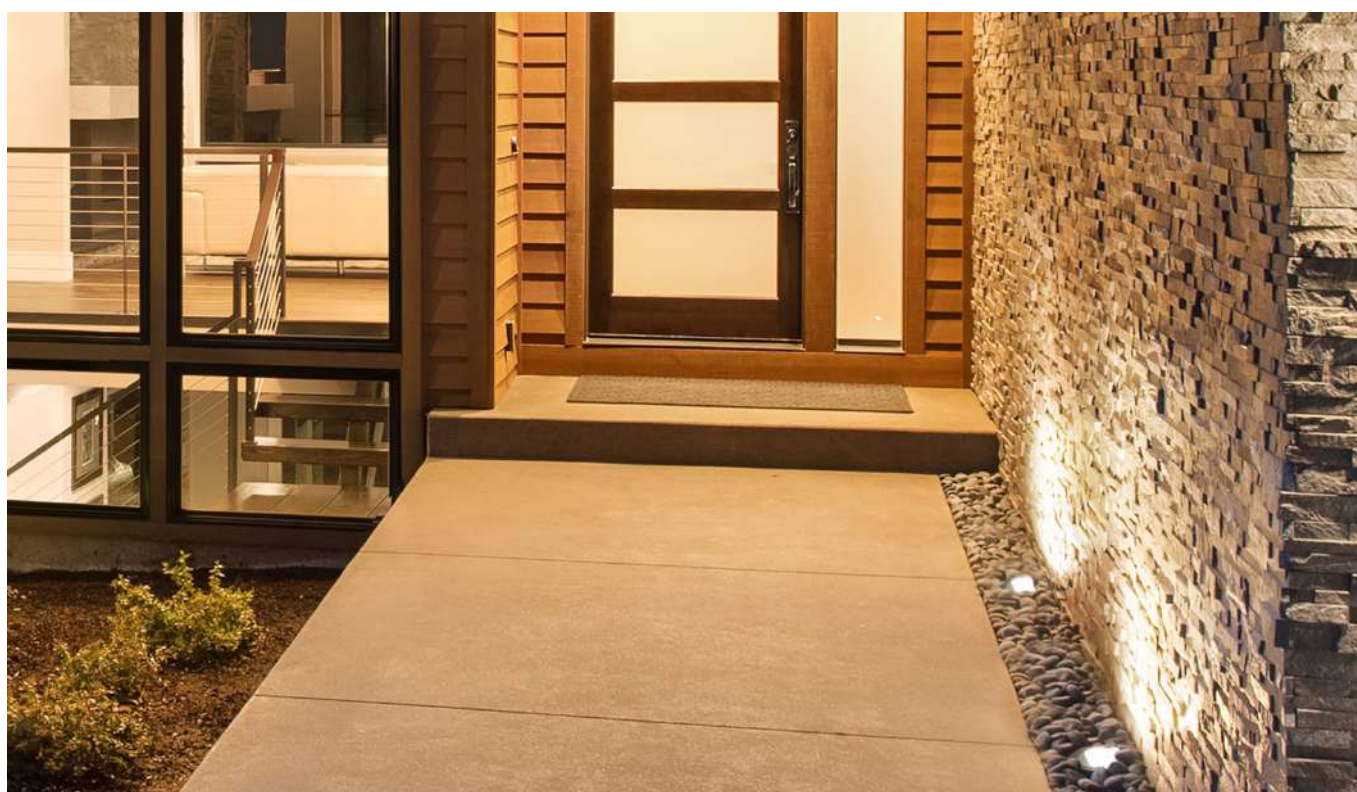



TILT 1

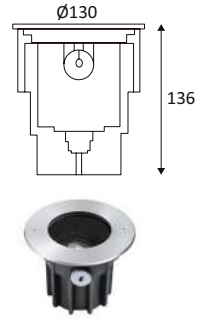

- Encastré de sol rond avec source orientable.
- Diffuseur en verre clair.
- Carrossable résistance 2000kg (max 24km/h).
- Inox 316 pour les zones côtières.
- Pot d'encastrement et 1m de câble H05RN-F (3x1.0mm²) fournis.
- Convertisseur dimmable intégré dans l'appareil.
- Compatible avec variateur début et fin de phase.
- Boîte de connexion étanche à commander séparément.

TILT 1	COULEUR	MATIÈRE	P	CCT	LED LUMEN	SYSTEM LUMEN	α	€
GLTMS119T30	ACIER INOXYDABLE	INOX 316	6W	3000K	550Lm	450Lm	34°	225,00

ACCESSOIRES	DESCRIPTION	L(MM)	€
JB5	BOITE DE CONNEXION PARALLELE AVEC GEL IP68	93,5	51,00
WC59	CONNECTEUR IP68	125	77,00

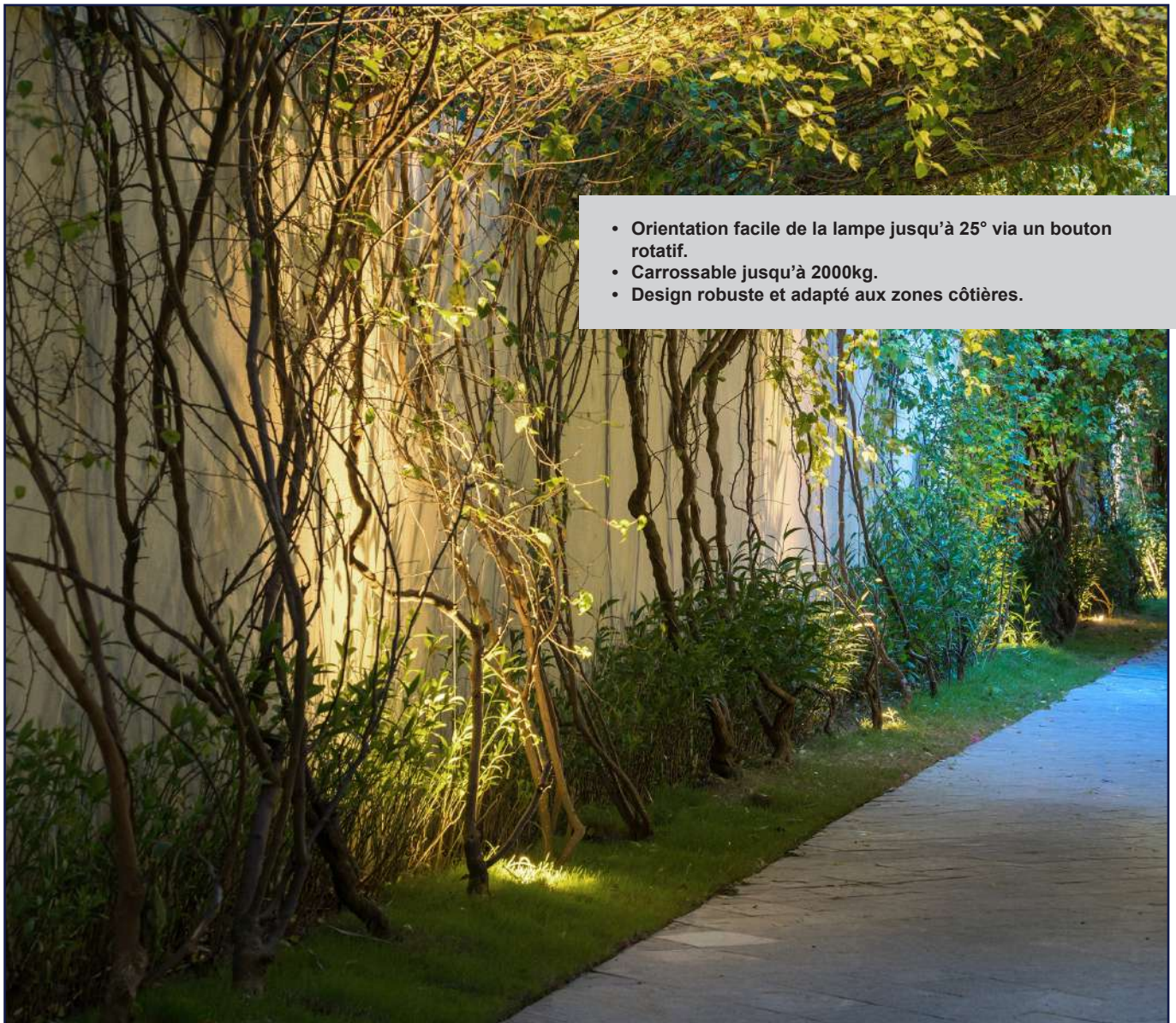

- Orientation facile de la lampe jusqu'à 25° via un bouton rotatif.
- Carrossable jusqu'à 2000kg.
- Design robuste et adapté aux zones côtières.

TILT 2



- Encastré de sol rond avec source orientable.
- Diffuseur en verre clair.
- Carrossable résistance 2000kg (max 24km/h).
- Inox 316 pour les zones côtières.
- Pot d'encastrement et 1m de câble H05RN-F (3x1.0mm²) fournis.
- Convertisseur dimmable intégré dans l'appareil.
- Compatible avec variateur début et fin de phase.
- Boîte de connexion étanche à commander séparément.

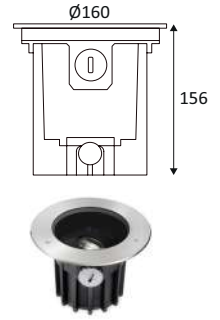

TILT 2	COULEUR	MATIÈRE	P	CCT	LED LUMEN	SYSTEM LUMEN	α	€
GLTMS147T30	ACIER INOXYDABLE	INOX 316	12W	3000K	1400Lm	1200Lm	34°	290,00

ACCESSOIRES	DESCRIPTION	L(MM)	€
JB5	BOITE DE CONNEXION PARALLELE AVEC GEL IP68	93,5	51,00
WC59	CONNECTEUR IP68	125	77,00

TILT 3



- Encastré de sol rond avec source orientable.
- Diffuseur en verre clair.
- Carrossable résistance 2000kg (max 24km/h).
- Inox 316 pour les zones côtières.
- Pot d'encastrement et 1m de câble H05RN-F (3x1.0mm²) fournis.
- Convertisseur dimmable intégré dans l'appareil.
- Compatible avec variateur début et fin de phase.
- Boîte de connexion étanche à commander séparément.

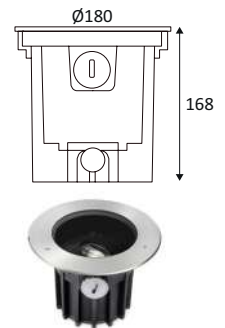

TILT 3	COULEUR	MATIÈRE	P	CCT	LED LUMEN	SYSTEM LUMEN	α	€
GLTMS165T30	ACIER INOXYDABLE	INOX 316	18W	3000K	2000Lm	1600Lm	34°	415,00

ACCESSOIRES	DESCRIPTION	L(MM)	€
JB5	BOITE DE CONNEXION PARALLELE AVEC GEL IP68	93,5	51,00
WC59	CONNECTEUR IP68	125	77,00



TILT 4

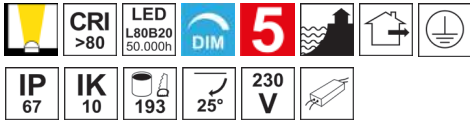

- Encastré de sol rond avec source orientable.
- Diffuseur en verre clair.
- Carrossable résistance 2000kg (max 24km/h).
- Inox 316 pour les zones côtières.
- Pot d'encastrement et 1m de câble H05RN-F (3x1.0mm²) fournis.
- Convertisseur dimmable intégré dans l'appareil.
- Compatible avec variateur début et fin de phase.
- Boîte de connexion étanche à commander séparément.

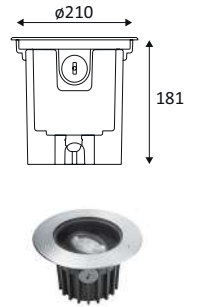

TILT 4	COULEUR	MATIÈRE	P	CCT	LED LUMEN	SYSTEM LUMEN	α	€
GLTMS193T30	■ ACIER INOXYDABLE	INOX 316	23W	3000K	3000Lm	2300Lm	34°	810,00

ACCESSOIRES	DESCRIPTION	L(MM)	€
JB5	BOITE DE CONNEXION PARALLELE AVEC GEL IP68	93,5	51
WC59	CONNECTEUR IP68	125	77

TILT 5



- Encastré de sol rond avec source orientable.
- Diffuseur en verre clair.
- Carrossable résistance 2000kg (max 24km/h).
- Inox 316 pour les zones côtières.
- Pot d'encastrement et 1m de câble H05RN-F (3x1.0mm²) fournis.
- Convertisseur dimmable intégré dans l'appareil.
- Compatible avec variateur début et fin de phase.
- Boîte de connexion étanche à commander séparément.

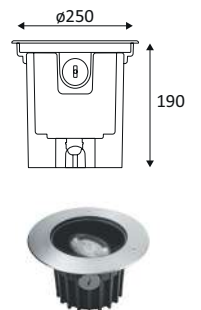

TILT 5	COULEUR	MATIÈRE	P	CCT	LED LUMEN	SYSTEM LUMEN	α	€
GLTMS223T30	■ ACIER INOXYDABLE	INOX 316	30W	3000K	4000Lm	3300Lm	34°	1030,00

ACCESSOIRES	DESCRIPTION	L(MM)	€
JB5	BOITE DE CONNEXION PARALLELE AVEC GEL IP68	93,5	51,00
WC59	CONNECTEUR IP68	125	77,00

GL100 II

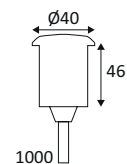

- Semi-encastré de sol rond pour balisage.
- Diffusion de la lumière dans une, deux, trois ou quatre directions.
- Inox 316 pour les zones côtières.
- Tube d'encastrement et 1m de câble H05RN-F fourni (diamètre 6mm).
- Immergeable jusqu'à 9m de profondeur.
- Convertisseur 150 à 700mA à commander séparément.
- Boîte de raccordement étanche à commander séparément.



GL100 II	COULEUR	MATIÈRE	P	CCT	LED LUMEN	α	€
1 FENÊTRE							
GL100SS1W30 NEW	■	ACIER INOXYDABLE	INOX 316	0,4 - 2,2W	3000K	290Lm	6Lm 75° 185,00
2 FENÊTRES / 1 DIRECTION							
GL100SS2W30 NEW	■	ACIER INOXYDABLE	INOX 316	0,4 - 2,2W	3000K	290Lm	11Lm 75° 185,00
2 FENÊTRES / 2 DIRECTIONS							
GL100SS2O30 NEW	■	ACIER INOXYDABLE	INOX 316	0,4 - 2,2W	3000K	290Lm	11Lm 75° 185,00
3 FENÊTRES							
GL100SS3W30 NEW	■	ACIER INOXYDABLE	INOX 316	0,4 - 2,2W	3000K	290Lm	16Lm 75° 185,00
4 FENÊTRES							
GL100SS4W30 NEW	■	ACIER INOXYDABLE	INOX 316	0,4 - 2,2W	3000K	290Lm	20Lm 75° 185,00

ACCESSOIRES	DESCRIPTION	L(MM)	€
JB2	BOITE DE RACCORDEMENT SERIE 3 SORTIES IP68	95	12,00
JB4	BOITE DE CONNEXION SERIE AVEC GEL IP68	93,5	51,00
JB6	CONNECTEUR AVEC GEL IP68	40	31,00

CONVERTISSEURS ET SOURCES	WATT MAX	€
PSIP3509W DRIVER 1-9W 350MA CC IP65	1-9W	49,00
PSIP35018W DRIVER 9-18W 350MA CC IP65	9-18W	65,00
PSIP70018W DRIVER 2-18W 700MA CC IP65	2-18W	65,00
PSIP70036W DRIVER 18-36W 700MA CC IP65	18-36W	83,00
DRV150700 DRIVER 6-30W 150-250-350-500-700MA CC	6-30W	46,00
DRV350700TD DRIVER 14-20W 350-500-700MA CC DIM	14-20W	72,00





GL200

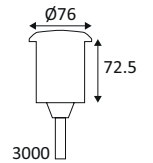
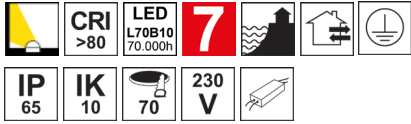

- Semi-encastré de sol rond pour balisage.
- Diffusion de la lumière dans une, deux, trois ou quatre directions.
- Inox 316 pour les zones côtières.
- 3m de câble H05RN-F fourni (diamètre 7mm).
- Convertisseur non dimmable intégré dans l'appareil.
- Tube d'encastrement et boîte de raccordement étanche à commander séparément.



GL200	COULEUR	MATIÈRE	P	CCT	LED LUMEN	SYSTEM LUMEN	α	€	
1 FENÊTRE									
GL200DX1X30	■	ACIER INOXYDABLE	INOX 316	5,7W	3000K	270Lm	10Lm	90°	285,00
2 FENÊTRES / 1 DIRECTION									
GL200DX2130	■	ACIER INOXYDABLE	INOX 316	5,7W	3000K	270Lm	20Lm	90°	285,00
2 FENÊTRES / 2 DIRECTIONS									
GL200DX2230	■	ACIER INOXYDABLE	INOX 316	5,7W	3000K	270Lm	20Lm	90°	285,00
3 FENÊTRES									
GL200DX3X30	■	ACIER INOXYDABLE	INOX 316	5,7W	3000K	270Lm	30Lm	90°	285,00
4 FENÊTRES									
GL200DX4X30	■	ACIER INOXYDABLE	INOX 316	5,7W	3000K	270Lm	40Lm	90°	285,00

ACCESSOIRES	MATIÈRE	DESCRIPTION	L(MM)	€
TUBE68	ALUMINIUM	TUBE D'ENCASTREMENT 72X150MM		45,00
JB5		BOITE DE CONNEXION PARALLELE AVEC GEL IP68	93,5	51,00
WC59		CONNECTEUR IP68	125	77,00

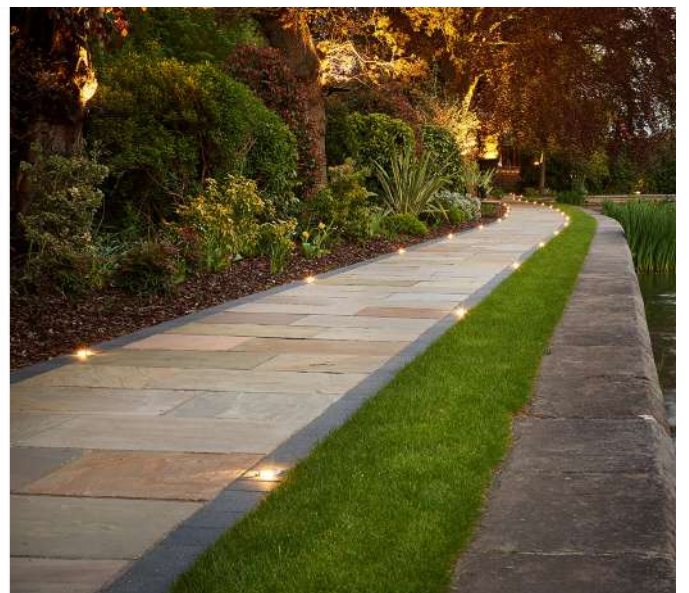
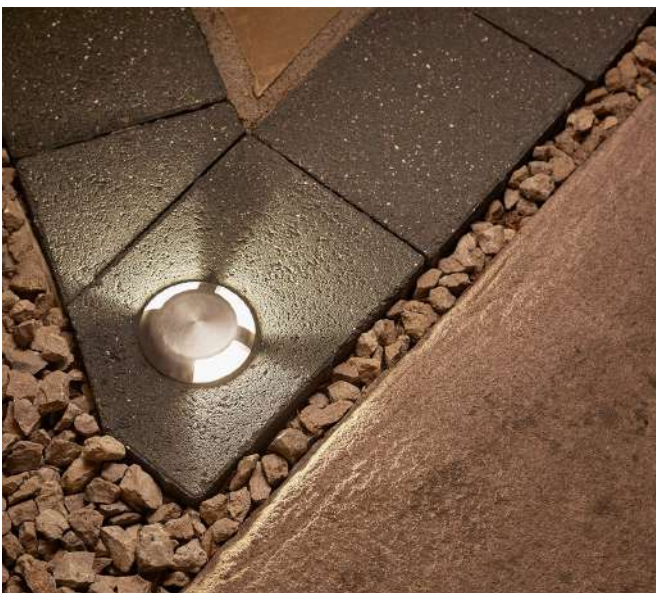

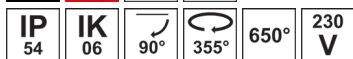

SPOTS SUR PIQUETS

LUXI 65 GU10

- Spot d'accentuation pour éclairage extérieur.
- Câble 2.00m et piquet à enterrer inclus.



LUXI 65 GU10	COULEUR	MATIÈRE	L(MM)	DOUILLE	LAMPE	WATT MAX	€
OU10824	 ANTHRACITE	FONTE D'ALUMINIUM	95	GU10	PAR16 LED	11W	69,00
ACCESSOIRES	DESCRIPTION						€
OU48405	CONNECTEUR 2PIN IP68						11,00
OU48505	CONNECTEUR 3PIN IP68						30,00



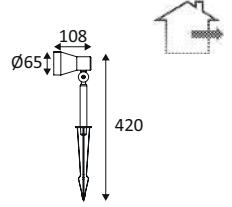

TURA GU10



- Spot d'accentuation pour éclairage extérieur.
- Câble 2.00m et piquet à enterrer inclus.



TURA GU10	COULEUR	MATIÈRE	L(MM)	DOUILLE	LAMPE	WATT MAX	€
OU43624	ANTHRACITE	FONTE D'ALUMINIUM	108	GU10	PAR16 LED	11W	65,00
ACCESSOIRES	DESCRIPTION						€
OU48405	CONNECTEUR 2PIN IP68						11,00
OU48505	CONNECTEUR 3PIN IP68						30,00

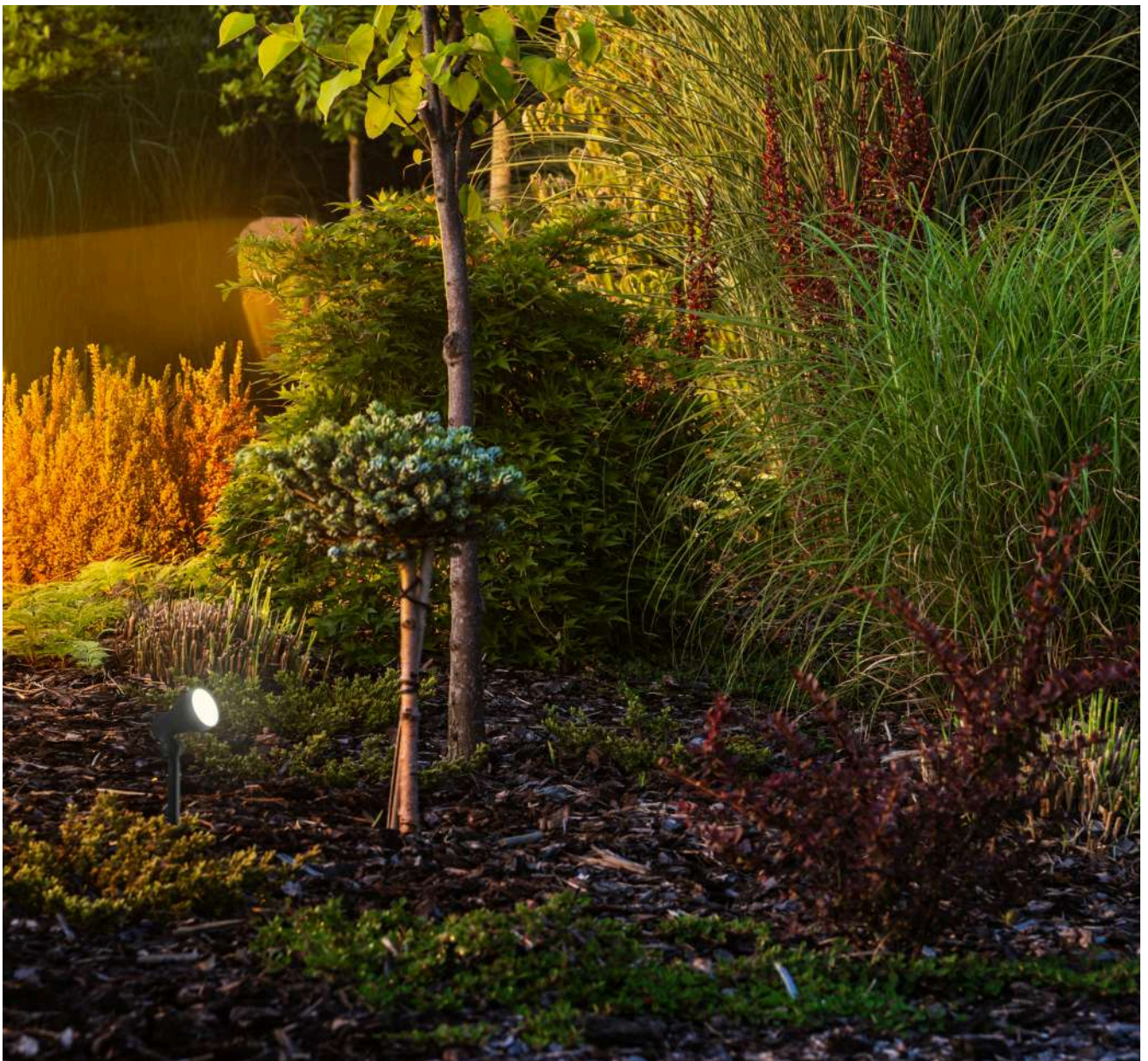

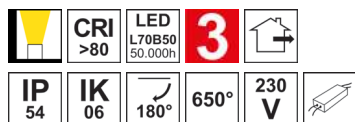

OLA 1



- Spot d'accentuation pour éclairage extérieur.
- Câble 0.30m et piquet à enterrer inclus.
- Convertisseur non dimmable intégré dans l'appareil.
- Accessoire inclus : plaque occultante amovible.



OLA 1	COULEUR	MATIÈRE	P	CCT	H(MM)	LED LUMEN	SYSTEM LUMEN	€
OU482WW05	■ NOIR MAT	ALUMINIUM	3W	3000K	320	420Lm	230Lm	120,00
OU483WW05	■ NOIR MAT	ALUMINIUM	3W	3000K	570	420Lm	230Lm	125,00
ACCESSOIRES	DESCRIPTION		€					
OU48405	CONNECTEUR 2PIN IP68		 11,00					
OU48505	CONNECTEUR 3PIN IP68		 30,00					

DANS LA MÊME GAMME







OLA 2 PAGE 415

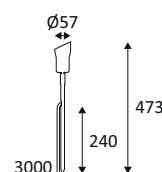

SL040A



- Spot d'accentuation pour éclairage extérieur.
- Avec visière basse luminance.
- Câble H05RN-F 3.00m (diamètre 6mm) et piquet à enterrer inclus.
- Convertisseur 700mA à commander séparément.
- Boîte de raccordement étanche à commander séparément.



SL040A	COULEUR	MATIÈRE	P	CCT	SYSTEM LUMEN	α	€
SL040AFWW	■ NOIR	ALUMINIUM	7W	3000K	413Lm	38°	225,00
ACCESSOIRES	DESCRIPTION		L(MM)	€			
JB2	BOITE DE RACCORDEMENT SERIE 3 SORTIES IP68		95	 12,00			
JB4	BOITE DE CONNEXION SERIE AVEC GEL IP68		93,5	 51,00			
JB6	CONNECTEUR AVEC GEL IP68		40	 31,00			
WCR275BLACK	CABLE H05RN-F 2X0,75MM² 1M		1000	 8,00			

CONVERTISSEURS ET SOURCES		WATT MAX		€
PSIP70018W	DRIVER 2-18W 700MA CC IP65		2-18W	65,00
PSIP70036W	DRIVER 18-36W 700MA CC IP65		18-36W	83,00



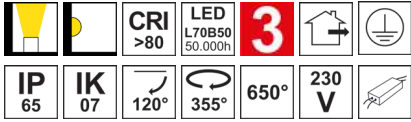

BRAMA 1

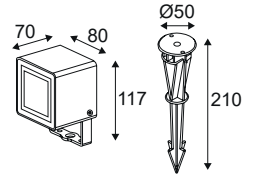

- Spot d'accentuation pour éclairage extérieur.
- Câble 1.50m et piquet à enterrer inclus.
- Double presse-étoupe.
- Convertisseur non dimmable intégré dans l'appareil.





BRAMA 1	COULEUR	MATIÈRE	P	CCT	LED LUMEN	SYSTEM LUMEN	α	€
OU345WW24	■ ANTHRACITE	FONTE D'ALUMINIUM	7W	3000K	1000Lm	595Lm	40°	160,00
ACCESSOIRES	DESCRIPTION							€
OU48405	CONNECTEUR 2PIN IP68							11,00
OU48505	CONNECTEUR 3PIN IP68							30,00

BRAMA 2

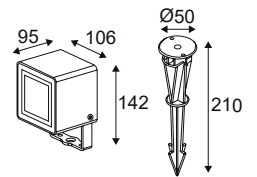

- Spot d'accentuation pour éclairage extérieur.
- Câble 1.50m et piquet à enterrer inclus.
- Double presse-étoupe.
- Ne nécessite pas de convertisseur.
- Non dimmable.



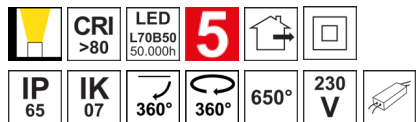

BRAMA 2	COULEUR	MATIÈRE	P	CCT	LED LUMEN	SYSTEM LUMEN	α	€
OU346WW24	■ ANTHRACITE	FONTE D'ALUMINIUM	20W	3000K	1800Lm	1565Lm	30°	210,00
ACCESSOIRES	DESCRIPTION							€
OU48405	CONNECTEUR 2PIN IP68							11,00
OU48505	CONNECTEUR 3PIN IP68							30,00

BASIL 1 P

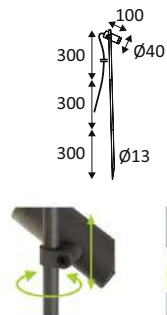
- Spot d'accentuation pour éclairage extérieur.
- Hauteur de tige réglable : 60 ou 90cm.
- Disposition du spot ajustable.
- Câble 2.50m et piquet à enterrer inclus.
- Convertisseur non dimmable intégré dans l'appareil.



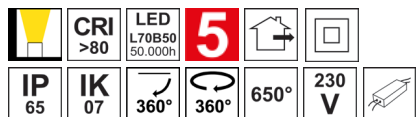

BASIL 1 P	COULEUR	MATIÈRE	P	CCT	LED LUMEN	SYSTEM LUMEN	α	€
OU517WW05	■ NOIR MAT	ALUMINIUM	4W	3000K	475Lm	295Lm	50°	145,00
ACCESSOIRES	DESCRIPTION							€
OU48405	CONNECTEUR 2PIN IP68							11,00
OU48505	CONNECTEUR 3PIN IP68							30,00

BASIL 2 P

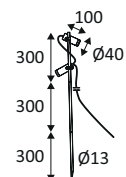
- Spot d'accentuation pour éclairage extérieur.
- Hauteur de tige réglable : 60 ou 90cm.
- Disposition des spots ajustable.
- Câble 2.50m et piquet à enterrer inclus.
- Convertisseurs non dimmables intégrés dans l'appareil.



BASIL 2 P	COULEUR	MATIÈRE	P	CCT	LED LUMEN	SYSTEM LUMEN	α	€
OU518WW05	■ NOIR MAT	ALUMINIUM	8W	3000K	2X475Lm	590Lm	50°	215,00
ACCESSOIRES	DESCRIPTION							€
OU48405	CONNECTEUR 2PIN IP68							11,00
OU48505	CONNECTEUR 3PIN IP68							30,00



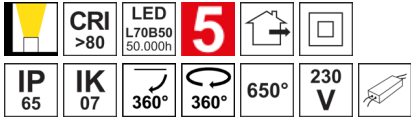

BASIL 3 P

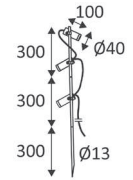

- Spot d'accentuation pour éclairage extérieur.
- Hauteur de tige réglable : 60 ou 90cm.
- Disposition des spots ajustable.
- Câble 2.50m et piquet à enterrer inclus.
- Convertisseurs non dimmables intégrés dans l'appareil.



BASIL 3 P	COULEUR	MATIÈRE	P	CCT	LED LUMEN	SYSTEM LUMEN	α	€
OU519WW05	■ NOIR MAT	ALUMINIUM	12W	3000K	3X475Lm	885Lm	50°	285,00
ACCESSOIRES	DESCRIPTION							€
OU48405	CONNECTEUR 2PIN IP68							11,00
OU48505	CONNECTEUR 3PIN IP68							30,00



SPOTTY 1 P

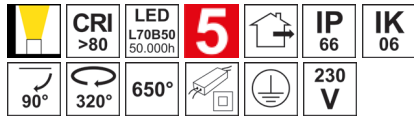

- Spot d'accentuation pour éclairage extérieur.
- Hauteur de tige réglable : 30, 60 ou 90cm.
- Piquet à enterrer ou base de fixation et kit d'ancrage à commander séparément.
- Convertisseur non dimmable intégré dans l'appareil.

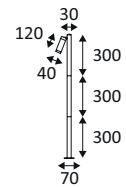

SPOTTY 1 P	COULEUR	MATIÈRE	P	CCT	LED LUMEN	SYSTEM LUMEN	α	€
PT090/01/M/3K/A	■ ANTHRACITE	ALUMINIUM	6W	3000K	600Lm	400Lm	30°	250,00
ACCESSOIRES	COULEUR	MATIÈRE	DESCRIPTION					€
PT090/BASE/A	ANTHRACITE	ALUMINIUM + THERMOPLASTIQUE	BASE DE FIXATION 160MM					82,00
PT090/SPIKE/A	ANTHRACITE	ALUMINIUM	PIQUET A ENTERRER					26,00
KIT/PT090		ACIER	KIT D'ANCRAGE					51,00

DANS LA MÊME GAMME



SPOTTY 2 W PAGE 440



SPOTTY 3 W PAGE 440



SPOTTY 1 W PAGE 439





SPOTTY 2 P

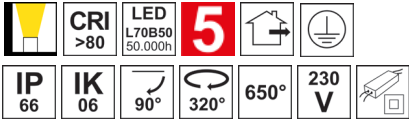

- Spot d'accentuation pour éclairage extérieur.
- Hauteur de tige réglable : 30, 60 ou 90cm.
- Piquet à enterrer ou base de fixation et kit d'ancrage à commander séparément.
- Convertisseur non dimmable intégré dans l'appareil.

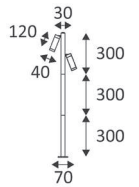

SPOTTY 2 P	COULEUR	MATIÈRE	P	CCT	LED LUMEN	SYSTEM LUMEN	α	€
PT090/02/M/3K/A	■ ANTHRACITE	ALUMINIUM	11,5W	3000K	2X600Lm	800Lm	30°	350,00
ACCESSOIRES	COULEUR	MATIÈRE	DESCRIPTION					€
PT090/BASE/A	ANTHRACITE	ALUMINIUM + THERMOPLASTIQUE	BASE DE FIXATION 160MM					82,00
PT090/SPIKE/A	ANTHRACITE	ALUMINIUM	PIQUET A ENTERRER					26,00
KIT/PT090		ACIER	KIT D'ANCRAGE					51,00

DANS LA MÊME GAMME



SPOTTY 1 W PAGE 439



SPOTTY 2 W PAGE 440



SPOTTY 3 W PAGE 440



GUNZY



- Spot d'accentuation pour éclairage extérieur.
- Câble 2.00m et piquet à enterrer en acier inoxydable inclus.
- Ne nécessite pas de convertisseur.
- Non dimmable.

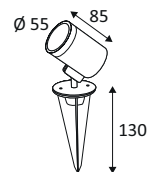

GUNZY	COULEUR	MATIÈRE	P	CCT	LED LUMEN	SYSTEM LUMEN	α	€
OU458WW24	ANTHRACITE	FONTE D'ALUMINIUM	8W	3000K	760Lm	465Lm	38°	180,00

ACCESSOIRES	DESCRIPTION	€
OU48405	CONNECTEUR 2PIN IP68	11,00
OU48505	CONNECTEUR 3PIN IP68	30,00

DANS LA MÊME GAMME



GUNZY S PAGE 441



GUNZY 2 S PAGE 441

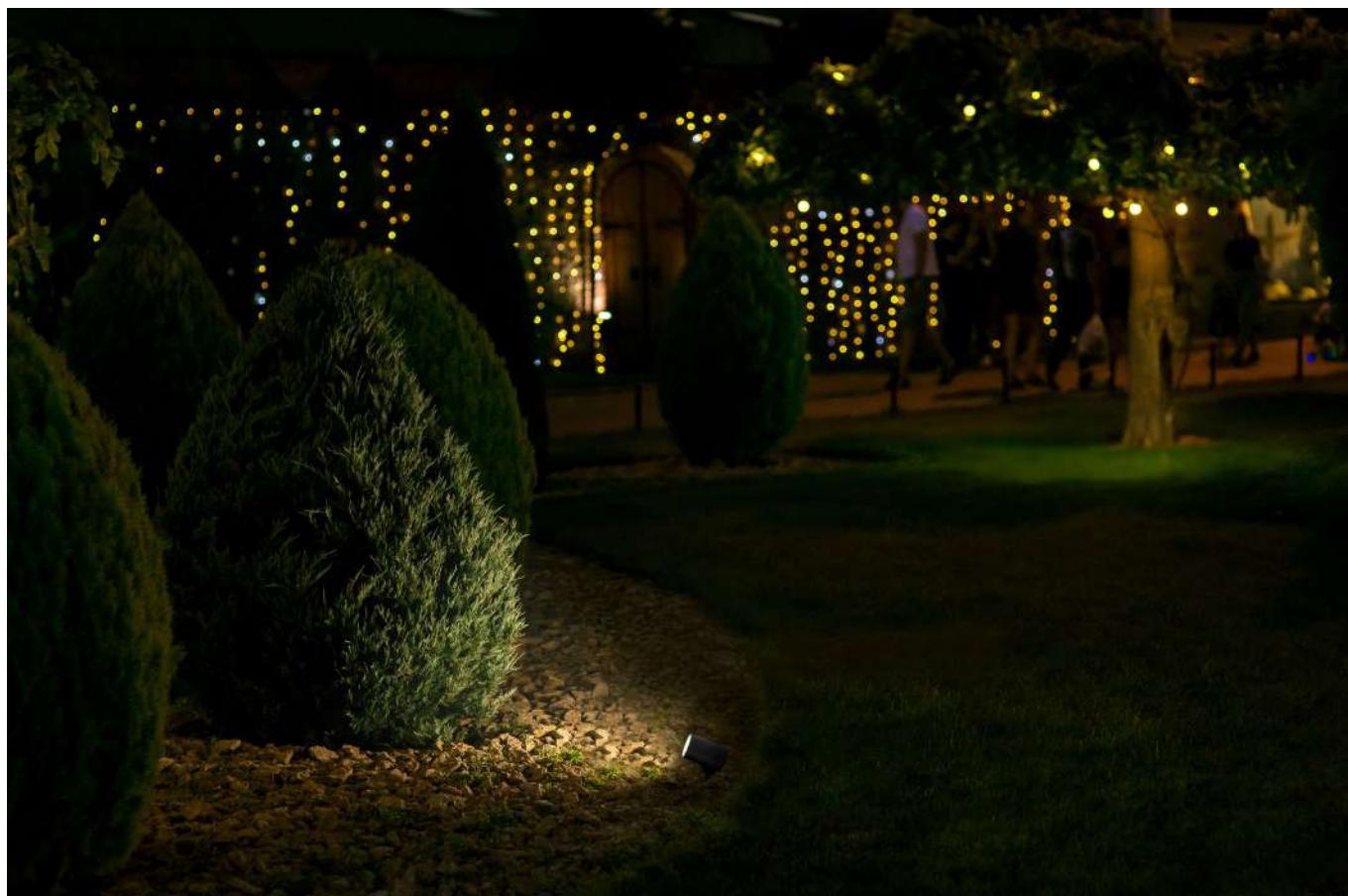



GUNZY P

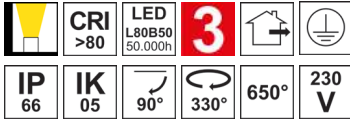

- Spot d'accentuation pour éclairage extérieur.
- Câble 2.50m et piquet à enterrer inclus.
- Ne nécessite pas de convertisseur.
- Non dimmable.

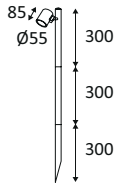

GUNZY P	COULEUR	MATIÈRE	P	CCT	L(MM)	LED LUMEN	SYSTEM LUMEN	α	€
OU18724	■ ANTHRACITE	FONTE D'ALUMINIUM	8W	3000K	85	760Lm	500Lm	38°	228,00

ACCESSOIRES	DESCRIPTION	€
OU48405	CONNECTEUR 2PIN IP68	11,00
OU48505	CONNECTEUR 3PIN IP68	30,00

DANS LA MÊME GAMME



GUNZY S PAGE 441



GUNZY 2 S PAGE 441

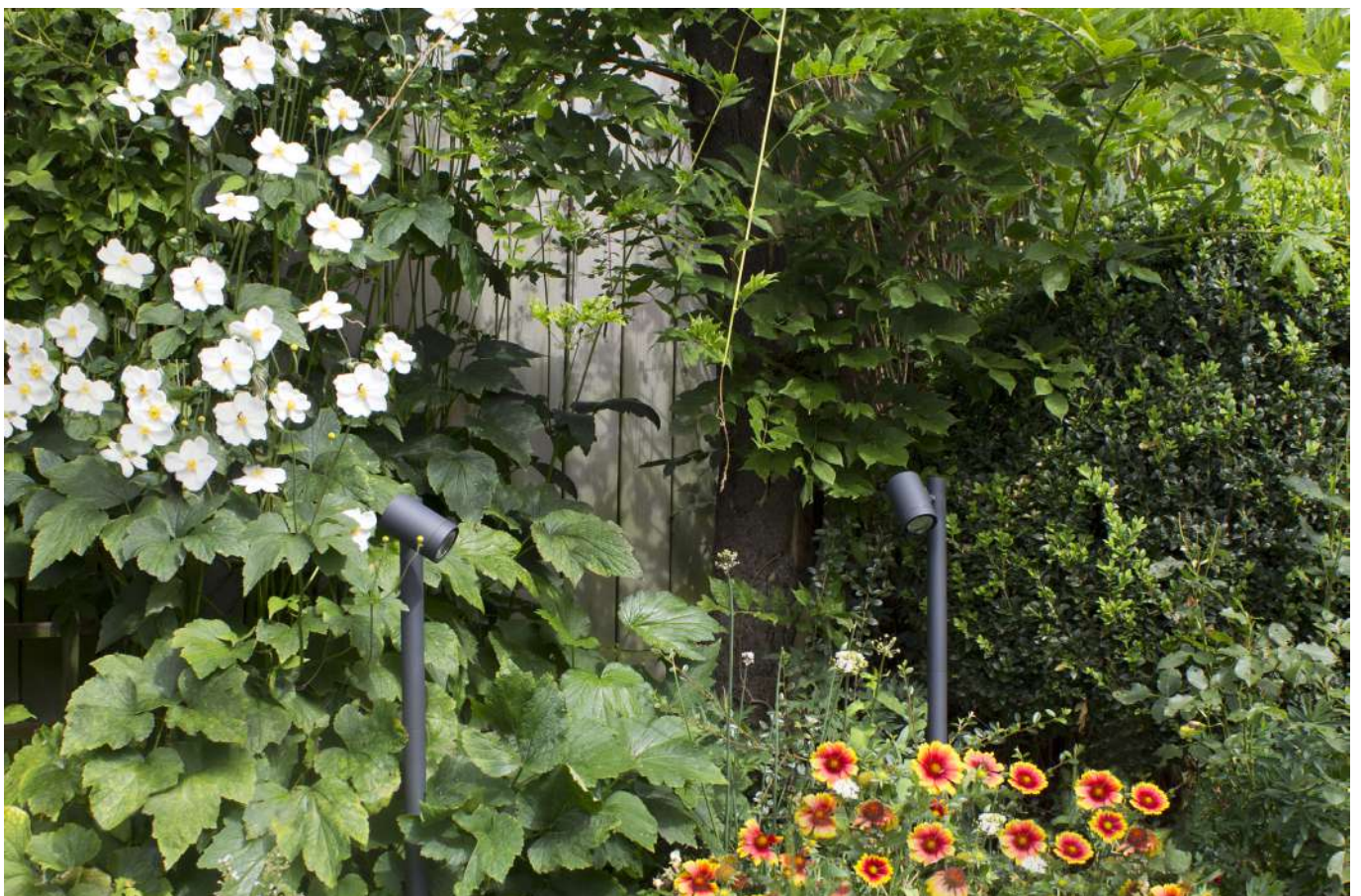

GUNZY 2 P



- Spot d'accentuation pour éclairage extérieur.
- Câble 2.50m et piquet à enterrer inclus.
- Ne nécessite pas de convertisseur.
- Non dimmable.

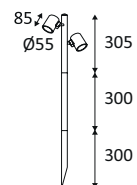

GUNZY 2 P	COULEUR	MATIÈRE	P	CCT	LED LUMEN	SYSTEM LUMEN	α	€
OU457WW24	■ ANTHRACITE	FONTE D'ALUMINIUM	16W	3000K	2X760Lm	925Lm	38°	310,00

ACCESSOIRES	DESCRIPTION	€
OU48405	CONNECTEUR 2PIN IP68	11,00
OU48505	CONNECTEUR 3PIN IP68	30,00

DANS LA MÊME GAMME



GUNZY 2 S PAGE 441



GUNZY S PAGE 441

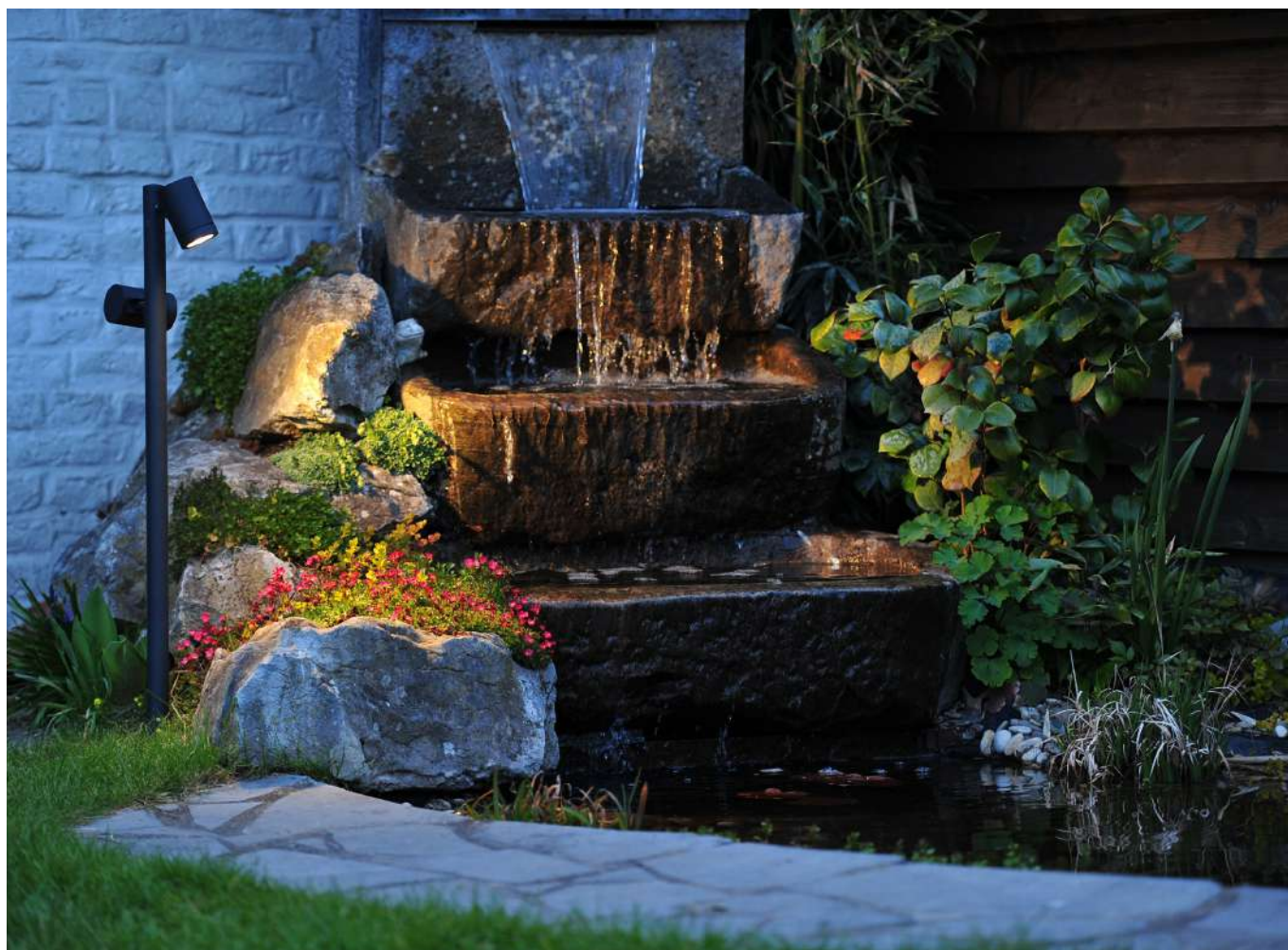



YUKA

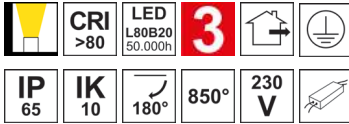

- Spot d'accentuation pour éclairage extérieur.
- Câble 0.60m, boîtier de connexion et piquet à enterrer inclus.
- Convertisseur non dimmable intégré dans l'appareil.

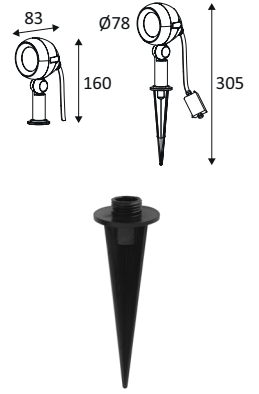

YUKA	COULEUR	MATIÈRE	P	CCT	LED LUMEN	SYSTEM LUMEN	α	€
OU497WW05	■ NOIR MAT	ALUMINIUM	8W	3000K	1100Lm	835Lm	60°	97

ANDY



- Spot d'accentuation pour éclairage extérieur.
- Câble 1.50m, boîtier de connexion et piquet à enterrer inclus.
- Ne nécessite pas de convertisseur.
- Non dimmable.

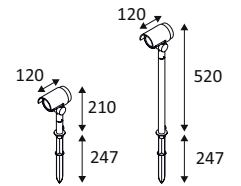

ANDY	COULEUR	MATIÈRE	P	CCT	H(MM)	LED LUMEN	SYSTEM LUMEN	α	€
OU465WW24	■ ANTHRACITE	FONTE D'ALUMINIUM	15W	3000K	210	1490Lm	985Lm	40°	165
OU466WW24	■ ANTHRACITE	FONTE D'ALUMINIUM	15W	3000K	520	1490Lm	985Lm	40°	180

FLORIA 1



- Spot d'accentuation à faisceau réglable pour éclairage extérieur.
- Tête interchangeable.
- Hauteurs de tige disponibles : 415, 615 ou 915mm.
- Câble 2m et piquet à enterrer inclus.
- Faisceau ajustable.
- Non dimmable.
- Convertisseur 24VDC à commander séparément.
- Le convertisseur peut être déporté jusqu'à 40m.

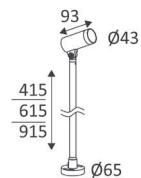

FLORIA 1	COULEUR	MATIÈRE	P	CCT	H(MM)	LED LUMEN	SYSTEM LUMEN	α	€
OU524SW05 NEW	■ NOIR MAT	ALUMINIUM	5W	2700K	415	415Lm	210Lm	20-48°	160,00
OU524WW05 NEW	■ NOIR MAT	ALUMINIUM	5W	3000K	415	415Lm	230Lm	20-48°	160,00
OU525SW05 NEW	■ NOIR MAT	ALUMINIUM	5W	2700K	615	615Lm	210Lm	20-48°	170,00
OU525WW05 NEW	■ NOIR MAT	ALUMINIUM	5W	3000K	615	615Lm	230Lm	20-48°	170,00
OU526SW05 NEW	■ NOIR MAT	ALUMINIUM	5W	2700K	915	915Lm	210Lm	20-48°	180,00
OU526WW05 NEW	■ NOIR MAT	ALUMINIUM	5W	3000K	915	915Lm	230Lm	20-48°	180,00

CONVERTISSEURS ET SOURCES				WATT MAX	€
5783	NEW	DRIVER 75W 24V CV IP67		75W	90,00
5784	NEW	DRIVER 100W 24V CV IP67		100W	120,00
5672	NEW	DRIVER 150W 24V CV IP67		150W	120,00
5947	NEW	DRIVER 240W 24V CV IP67		240W	280,00

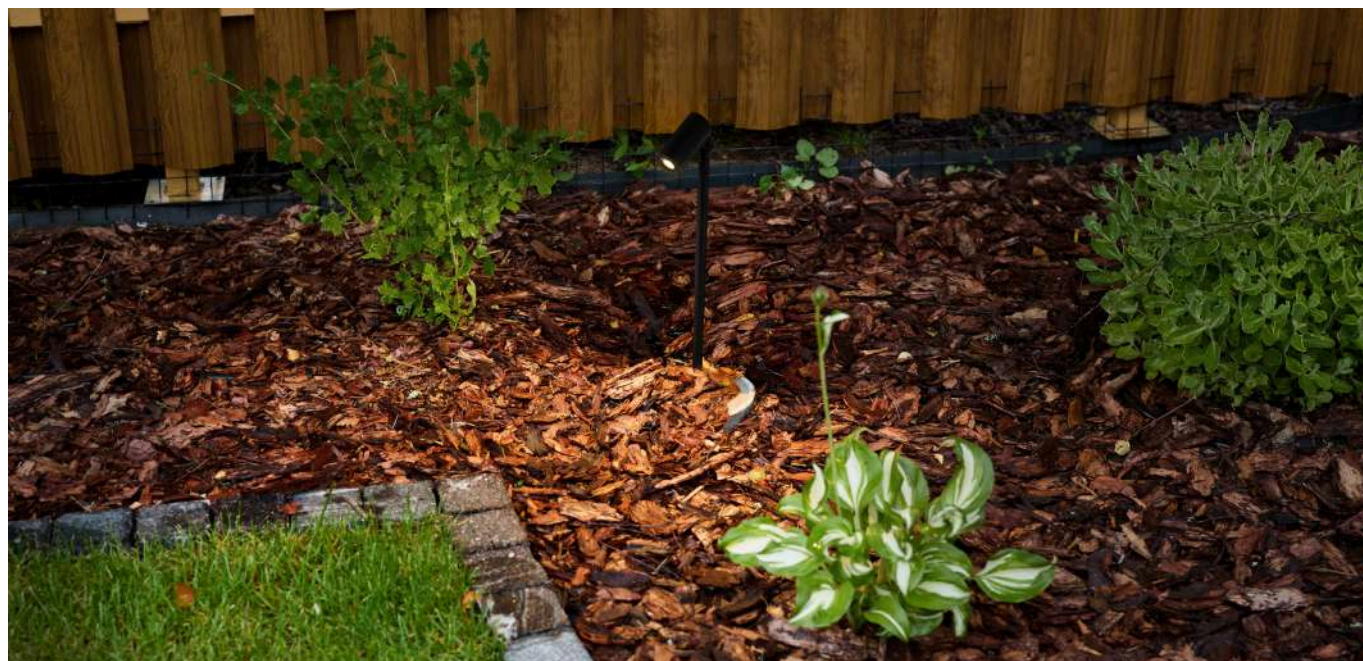



NEW

FLORIA 2

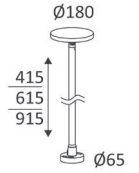

- Luminaire sur piquet décoratif pour éclairage extérieur.
- Tête inclinable et interchangeable.
- Hauteurs de tige disponibles : 415, 615 ou 915mm.
- Câble 2m et piquet à enterrer inclus.
- Non dimmable.
- Convertisseur 24VDC à commander séparément.
- Le convertisseur peut être déporté jusqu'à 40m.



FLORIA 2	COULEUR	MATIÈRE	P	CCT	H(MM)	LED LUMEN	SYSTEM LUMEN	α	€
OU527SW05 NEW	■ NOIR MAT	ALUMINIUM	6,3W	2700K	415	680Lm	450Lm	120°	170,00
OU527WW05 NEW	■ NOIR MAT	ALUMINIUM	6,3W	3000K	415	720Lm	490Lm	120°	170,00
OU528SW05 NEW	■ NOIR MAT	ALUMINIUM	6,3W	2700K	615	680Lm	450Lm	120°	180,00
OU528WW05 NEW	■ NOIR MAT	ALUMINIUM	6,3W	3000K	615	720Lm	490Lm	120°	180,00
OU529SW05 NEW	■ NOIR MAT	ALUMINIUM	6,3W	2700K	915	680Lm	450Lm	120°	190,00
OU529WW05 NEW	■ NOIR MAT	ALUMINIUM	6,3W	3000K	915	720Lm	490Lm	120°	190,00

CONVERTISSEURS ET SOURCES				WATT MAX	€
5783	NEW	DRIVER 75W 24V CV IP67		75W	90,00
5784	NEW	DRIVER 100W 24V CV IP67		100W	120,00
5672	NEW	DRIVER 150W 24V CV IP67		150W	120,00
5947	NEW	DRIVER 240W 24V CV IP67		240W	280,00

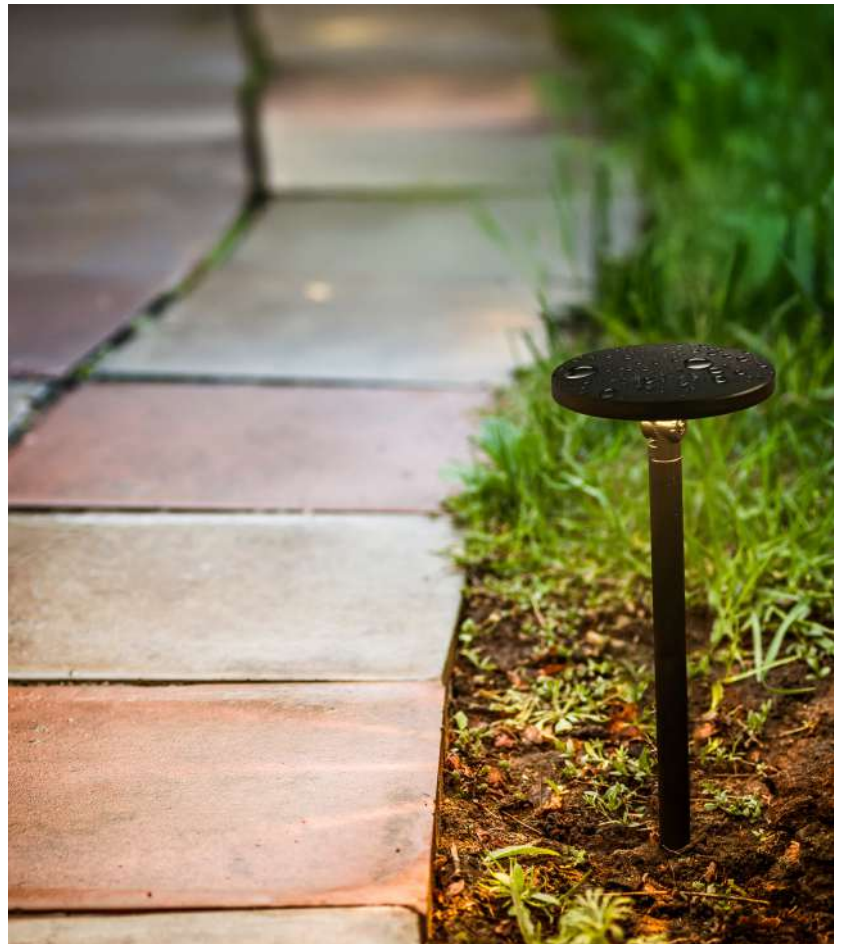

FLORIA 3



- Luminaire sur piquet décoratif pour éclairage extérieur.
- Tête inclinable et interchangeable.
- Hauteurs de tige disponibles : 415, 615 ou 915mm.
- Câble 2m et piquet à enterrer inclus.
- Non dimmable.
- Convertisseur 24VDC à commander séparément.
- Le convertisseur peut être déporté jusqu'à 40m.



FLORIA 3	COULEUR	MATIÈRE	P	CCT	H (mm)	LED LUMEN	SYSTEM LUMEN	α	€
OU530SW05 NEW	■ NOIR MAT	ALUMINIUM	4,8W	2700K	415	490Lm	240Lm	120°	190,00
OU530WW05 NEW	■ NOIR MAT	ALUMINIUM	4,8W	3000K	415	510Lm	260Lm	120°	190,00
OU531SW05 NEW	■ NOIR MAT	ALUMINIUM	4,8W	2700K	615	490Lm	240Lm	120°	200,00
OU531WW05 NEW	■ NOIR MAT	ALUMINIUM	4,8W	3000K	615	510Lm	260Lm	120°	200,00
OU532SW05 NEW	■ NOIR MAT	ALUMINIUM	4,8W	2700K	915	490Lm	240Lm	120°	210,00
OU532WW05 NEW	■ NOIR MAT	ALUMINIUM	4,8W	3000K	915	510Lm	260Lm	120°	210,00

CONVERTISSEURS ET SOURCES			WATT MAX	€
5783 NEW	DRIVER 75W 24V CV IP67		75W	90,00
5784 NEW	DRIVER 100W 24V CV IP67		100W	120,00
5672 NEW	DRIVER 150W 24V CV IP67		150W	120,00
5947 NEW	DRIVER 240W 24V CV IP67		240W	280,00

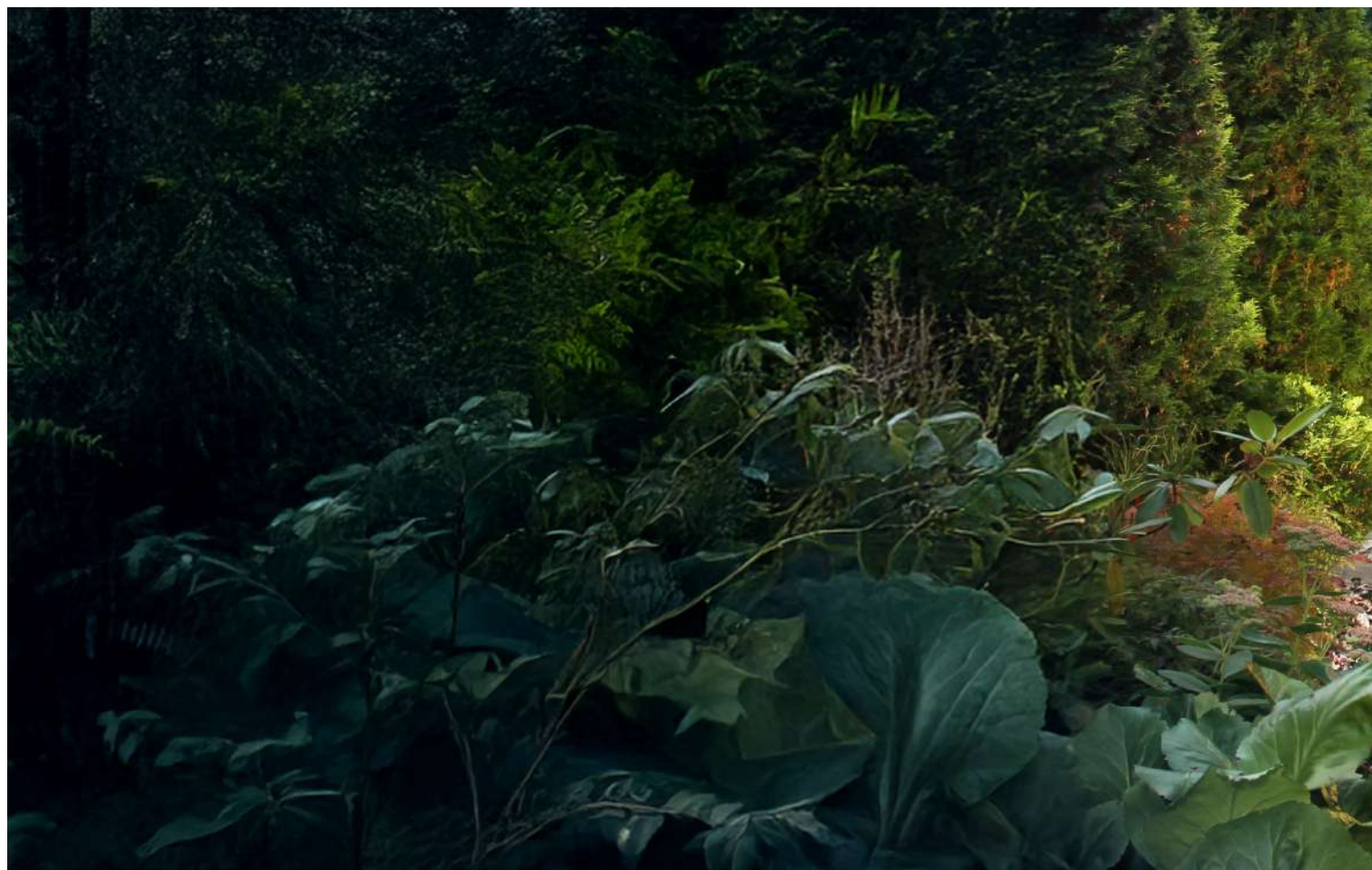

**FLORIA 4**

- Luminaire sur piquet décoratif pour éclairage extérieur.
- Tête inclinable et interchangeable.
- Hauteurs de tige disponibles : 415, 615 ou 915mm.
- Câble 2m et piquet à enterrer inclus.
- Non dimmable.
- Convertisseur 24VDC à commander séparément.
- Le convertisseur peut être déporté jusqu'à 40m.

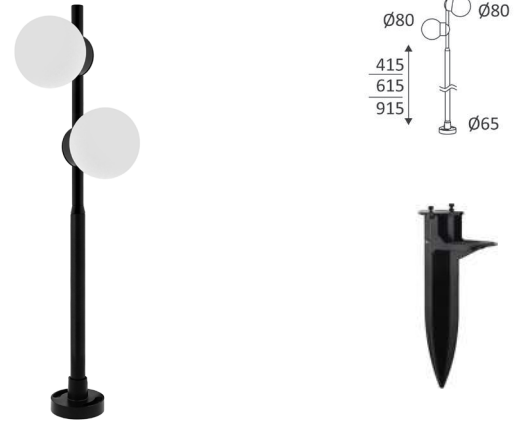

FLORIA 4	COULEUR	MATIÈRE	P	CCT	H (mm)	LED LUMEN	SYSTEM LUMEN	α	€
OU533SW05	NEW NOIR MAT	ALUMINIUM	9,6W	2700K	415	980Lm	480Lm	120°	290,00
OU533WW05	NEW NOIR MAT	ALUMINIUM	9,6W	3000K	415	1020Lm	520Lm	120°	290,00
OU534SW05	NEW NOIR MAT	ALUMINIUM	9,6W	2700K	615	980Lm	480Lm	120°	300,00
OU534WW05	NEW NOIR MAT	ALUMINIUM	9,6W	3000K	615	1020Lm	520Lm	120°	300,00
OU535SW05	NEW NOIR MAT	ALUMINIUM	9,6W	2700K	915	980Lm	480Lm	120°	310,00
OU535WW05	NEW NOIR MAT	ALUMINIUM	9,6W	3000K	915	1020Lm	520Lm	120°	310,00

CONVERTISSEURS ET SOURCES				WATT MAX	€
5783	NEW	DRIVER 75W 24V CV IP67		75W	90,00
5784	NEW	DRIVER 100W 24V CV IP67		100W	120,00
5672	NEW	DRIVER 150W 24V CV IP67		150W	120,00
5947	NEW	DRIVER 240W 24V CV IP67		240W	280,00



SL220 MAINS II

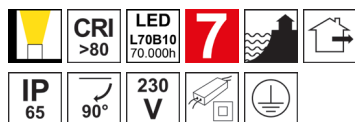

- Spot d'accentuation pour éclairage extérieur.
- Version inox 316 pour les zones côtières.
- Câble H05RN-F 3m (diamètre 7mm) et piquet à enterrer inclus.
- Convertisseur non dimmable intégré dans l'appareil.
- Boîte de connexion étanche à commander séparément.

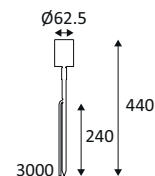

SL220 MAINS II	COULEUR	MATIÈRE	P	CCT	LED LUMEN	SYSTEM LUMEN	α	€
SL220BK30MF	NOIR MAT	ALUMINIUM	5,7W	3000K	620Lm	520Lm	40°	309,00
SL220SS30MF	ACIER INOXYDABLE	INOX 316	5,7W	3000K	620Lm	520Lm	40°	390,00
SL220BZ30MF	BRONZE	ALUMINIUM	5,7W	3000K	620Lm	520Lm	40°	330,00
SL220BK27MF	NEW NOIR MAT	ALUMINIUM	5,7W	2700K	620Lm	515Lm	40°	309,00
SL220BZ27MF	NEW BRONZE	ALUMINIUM	5,7W	2700K	620Lm	515Lm	40°	330,00
SL220SS27MF	NEW ACIER INOXYDABLE	INOX 316	5,7W	2700K	620Lm	515Lm	40°	390,00

ACCESSOIRES	COULEUR	MATIÈRE	DESCRIPTION	€
JB5			BOITE DE CONNEXION PARALLELE AVEC GEL IP68	51,00
GH220B	NOIR	ALUMINIUM	CYLINDRE ASYMETRIQUE	62,00
GH220D	ACIER INOXYDABLE	INOX 316	CYLINDRE ASYMETRIQUE	96,00
GH220Z	BRONZE	ALUMINIUM	CYLINDRE ASYMETRIQUE	62,00
GS220B	NOIR	ALUMINIUM	CYLINDRE BASSE LUMINANCE	62,00
GS220D	ACIER INOXYDABLE	INOX 316	CYLINDRE BASSE LUMINANCE	85,00
GS220Z	BRONZE	ALUMINIUM	CYLINDRE BASSE LUMINANCE	62,00



NOIR MAT



ACIER INOXYDABLE



BRONZE



SL230 MAINS

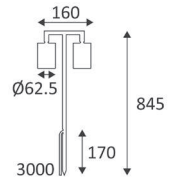
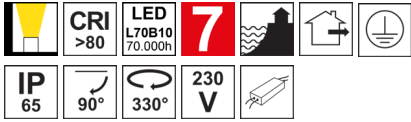

- Spot d'accentuation pour éclairage extérieur.
- Version inox 316 pour les zones côtières.
- Câble H05RN-F 3.00m (diamètre 7mm) et piquet à enterrer inclus.
- Convertisseur non dimmable intégré dans l'appareil.
- Boîte de connexion étanche à commander séparément.

SL230 MAINS	COULEUR	MATIÈRE	P	CCT	SYSTEM LUMEN	α	€
SL230BWB30	NOIR	ALUMINIUM	11,4W	3000K	1040Lm	40°	570,00
SL230DWB30	ACIER INOXYDABLE	INOX 316	11,4W	3000K	1040Lm	40°	650,00
SL230ZW30	BRONZE	ALUMINIUM	11,4W	3000K	1040Lm	40°	590,00

ACCESSOIRES	COULEUR	MATIÈRE	DESCRIPTION	€
JB5			BOITE DE CONNEXION PARALLELE AVEC GEL IP68	51,00
GH220B	NOIR	ALUMINIUM	CYLINDRE ASYMETRIQUE	62,00
GH220D	ACIER INOXYDABLE	INOX 316	CYLINDRE ASYMETRIQUE	96,00
GH220Z	BRONZE	ALUMINIUM	CYLINDRE ASYMETRIQUE	62,00
GS220B	NOIR	ALUMINIUM	CYLINDRE BASSE LUMINANCE	62,00
GS220D	ACIER INOXYDABLE	INOX 316	CYLINDRE BASSE LUMINANCE	85,00
GS220Z	BRONZE	ALUMINIUM	CYLINDRE BASSE LUMINANCE	62,00



NOIR



ACIER INOXYDABLE



BRONZE

BORNES

MINO P E27

- Borne ronde pour éclairage extérieur.
- Diffuseur en verre dépoli.

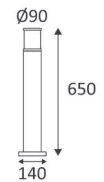

MINO P E27	COULEUR	MATIÈRE	DOUILLE	LAMPE	WATT MAX	€
OU43324	■ ANTHRACITE	Fonte d'aluminium	E27	CLASSIC A	26W	124,00

DANS LA MÊME GAMME

MINO W E27 PAGE 433

RONDO P E27

- Borne ronde pour éclairage extérieur.
- Corps anthracite et diffuseur en verre clair ou opalin.

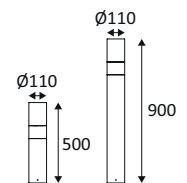

RONDO P E27	COULEUR	MATIÈRE	DOUILLE	LAMPE	WATT MAX	€
OU40024	■ ANTHRACITE + VERRE OPALIN	Fonte d'aluminium	E27	CLASSIC A	18W	162,00
OU40224	■ ANTHRACITE + VERRE CLAIR	Fonte d'aluminium	E27	CLASSIC A	18W	162,00
OU40124	■ ANTHRACITE + VERRE OPALIN	Fonte d'aluminium	E27	CLASSIC A	18W	215,00
OU40324	■ ANTHRACITE + VERRE CLAIR	Fonte d'aluminium	E27	CLASSIC A	18W	215,00

DANS LA MÊME GAMMEANTHRACITE +
VERRE OPALINANTHRACITE +
VERRE CLAIR

RONDO W E27 PAGE 433



TULO E27



- Borne carrée pour éclairage extérieur.
- Diffuseur en verre clair.

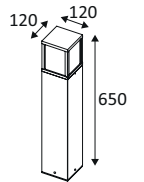

TULO E27	COULEUR	MATIÈRE	DOUILLE	LAMPE	WATT MAX	€
OU41424	ANTHRACITE	ALUMINIUM	E27	CLASSIC A	15W	195,00

TULO SENSOR E27



- Borne carrée pour éclairage extérieur.
- Avec détecteur IR 105°, rayon de détection max. 8m.
- Diffuseur en verre clair.

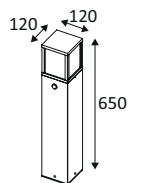

TULO SENSOR E27	COULEUR	MATIÈRE	DOUILLE	LAMPE	WATT MAX	€
OU41324	ANTHRACITE	ALUMINIUM	E27	CLASSIC A	15W	215,00



ELNE 1

- Luminaire extérieur pour balisage.
- Une fenêtre.
- Avec entrée et sortie de câble.
- Carrossable résistance 500kg.
- Convertisseur non dimmable intégré dans l'appareil.

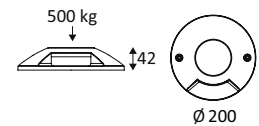

ELNE 1	COULEUR	MATIÈRE	P	CCT	LED LUMEN	SYSTEM LUMEN	€
OU450WW24	■ ANTHRACITE	ALUMINIUM	6W	3000K	400Lm	290Lm	126,00

ELNE 2

- Luminaire extérieur pour balisage.
- Deux fenêtres.
- Avec entrée et sortie de câble.
- Carrossable résistance 500kg.
- Convertisseur non dimmable intégré dans l'appareil.

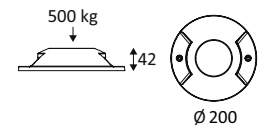

ELNE 2	COULEUR	MATIÈRE	P	CCT	LED LUMEN	SYSTEM LUMEN	€
OU451WW24	■ ANTHRACITE	ALUMINIUM	12W	3000K	2X400Lm	345Lm	138,00

ELNE 4

- Luminaire extérieur pour balisage.
- Quatre fenêtres.
- Avec entrée et sortie de câble.
- Carrossable résistance 500kg.
- Convertisseur non dimmable intégré dans l'appareil.

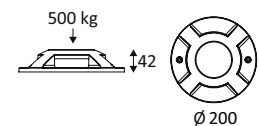

ELNE 4	COULEUR	MATIÈRE	P	CCT	LED LUMEN	SYSTEM LUMEN	€
OU452WW24	■ ANTHRACITE	ALUMINIUM	12W	3000K	4X300Lm	510Lm	152,00



ELNE 1



LUXI 54



- Borne rectangulaire pour éclairage extérieur.
- Convertisseur non dimmable intégré dans l'appareil.

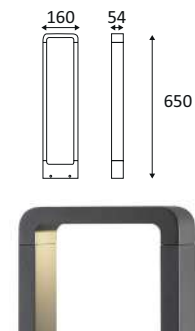

LUXI 54	COULEUR	MATIÈRE	P	CCT	LED LUMEN	SYSTEM LUMEN	α	€
OU13624	■ ANTHRACITE	ALUMINIUM	7W	3000K	750Lm	525Lm	90°	225,00

RAVEL



- Borne rectangulaire pour éclairage extérieur.
- Ne nécessite pas de convertisseur.

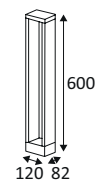

RAVEL	COULEUR	MATIÈRE	P	CCT	LED LUMEN	SYSTEM LUMEN	€
OU354NW24	■ ANTHRACITE	FORTE D'ALUMINIUM	10W	4000K	1100Lm	575Lm	189,00





LUXI 180

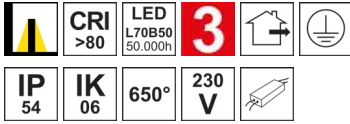

- Borne carrée pour éclairage extérieur.
- Peut être utilisé comme éclairage portatif grâce à la sortie de câble latérale.
- Convertisseur non dimmable intégré dans l'appareil.

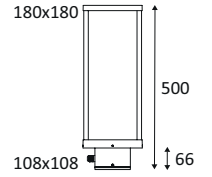

LUXI 180	COULEUR	MATIÈRE	P	CCT	LED LUMEN	SYSTEM LUMEN	€
OU318NW24	■ ANTHRACITE	FORTE D'ALUMINIUM	12W	4000K	1100Lm	720Lm	265,00

LUXI 175 SENSOR P

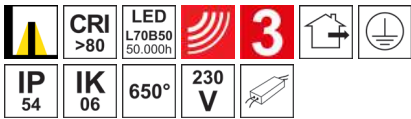

- Borne rectangulaire pour éclairage extérieur.
- Avec détecteur HF 120°, zone de détection réglable max. 8m.
- Diffuseur en polycarbonate opalin.
- Convertisseur non dimmable intégré dans l'appareil.

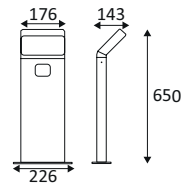

LUXI 175 SENSOR P	COULEUR	MATIÈRE	P	CCT	LED LUMEN	SYSTEM LUMEN	α	€
OU367WW24	■ ANTHRACITE	ALUMINIUM	9W	3000K	1260Lm	760Lm	105°	300,00
OU367NW24	■ ANTHRACITE	ALUMINIUM	9W	4000K	1300Lm	785Lm	105°	300,00

DANS LA MÊME GAMME



LUXI 175 SENSOR PAGE 445



AMONT

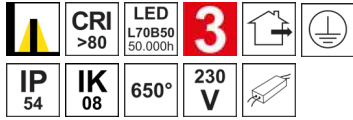

- Borne rectangulaire pour éclairage extérieur.
- Convertisseur non dimmable intégré dans l'appareil.

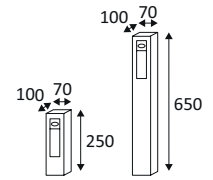

AMONT	COULEUR	MATIÈRE	P	CCT	H(MM)	LED LUMEN	SYSTEM LUMEN	α	€
OU357WW24	ANTHRACITE - DORÉ	ALUMINIUM	7W	3000K	250	750Lm	90Lm	60°	138,00
OU358WW24	ANTHRACITE - DORÉ	ALUMINIUM	7W	3000K	650	750Lm	90Lm	60°	180,00

LUXI 650



- Borne ronde pour éclairage extérieur.
- Avec entrée et sortie de câble.
- Convertisseur non dimmable intégré dans l'appareil.

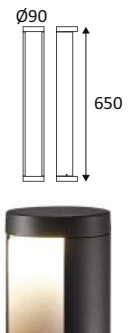

LUXI 650	COULEUR	MATIÈRE	P	CCT	LED LUMEN	SYSTEM LUMEN	α	€
OU13824	ANTHRACITE	FONTE D'ALUMINIUM	7W	3000K	660Lm	475Lm	30°	208,00

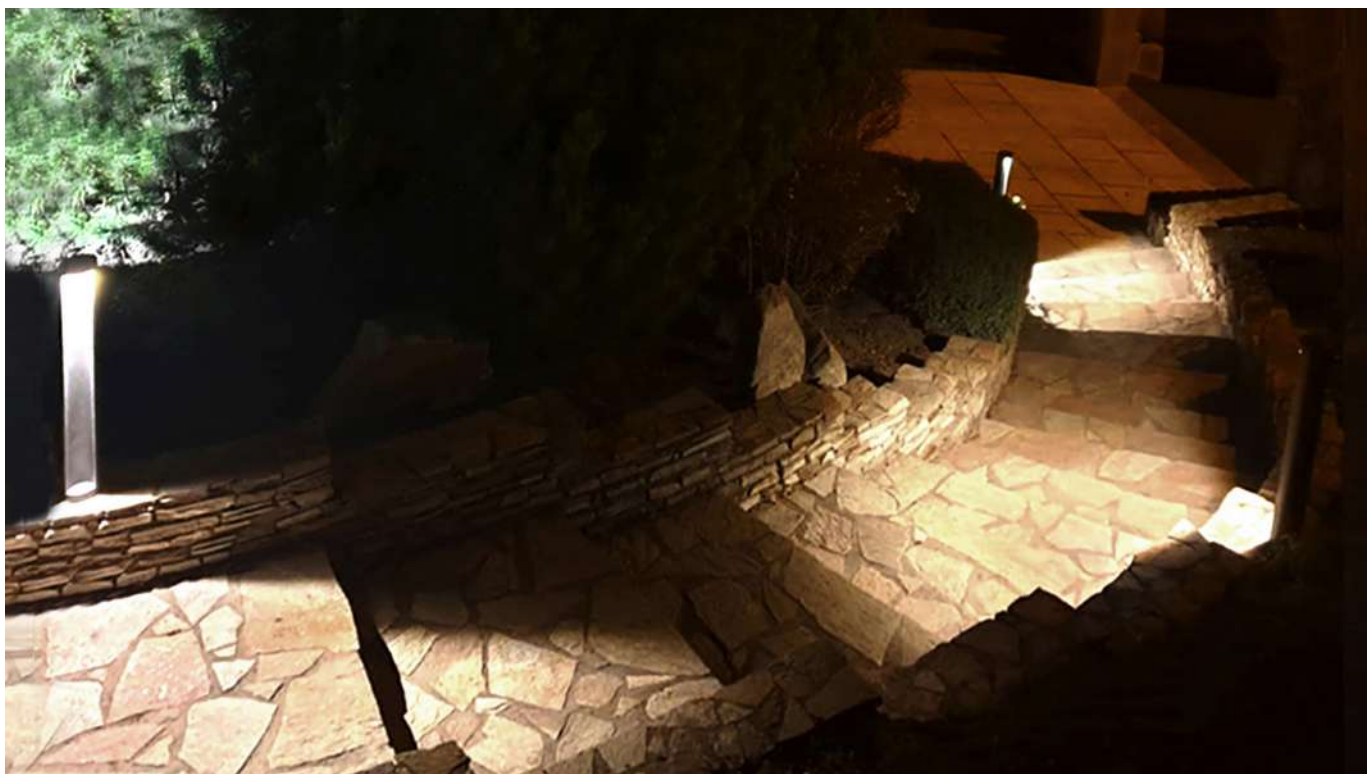



STELLA



- Borne ronde pour éclairage extérieur.
- Convertisseur non dimmable intégré dans l'appareil.

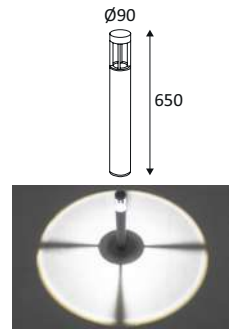

STELLA	COULEUR	MATIÈRE	P	CCT	LED LUMEN	SYSTEM LUMEN	€
OU353WW24	■ ANTHRACITE	FONTE D'ALUMINIUM	8W	3000K	825Lm	500Lm	178,00
OU353NW24	■ ANTHRACITE	FONTE D'ALUMINIUM	8W	4000K	900Lm	595Lm	178,00



FINN P



- Borne ronde pour éclairage extérieur.
- Diffuseur en polycarbonate.
- Ne nécessite pas de convertisseur.

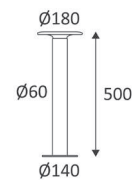

FINN P	COULEUR	MATIÈRE	P	CCT	LED LUMEN	SYSTEM LUMEN	α	€
OU503WW05	■ NOIR MAT	ALUMINIUM	10W	3000K	1100Lm	935Lm	100°	148,00

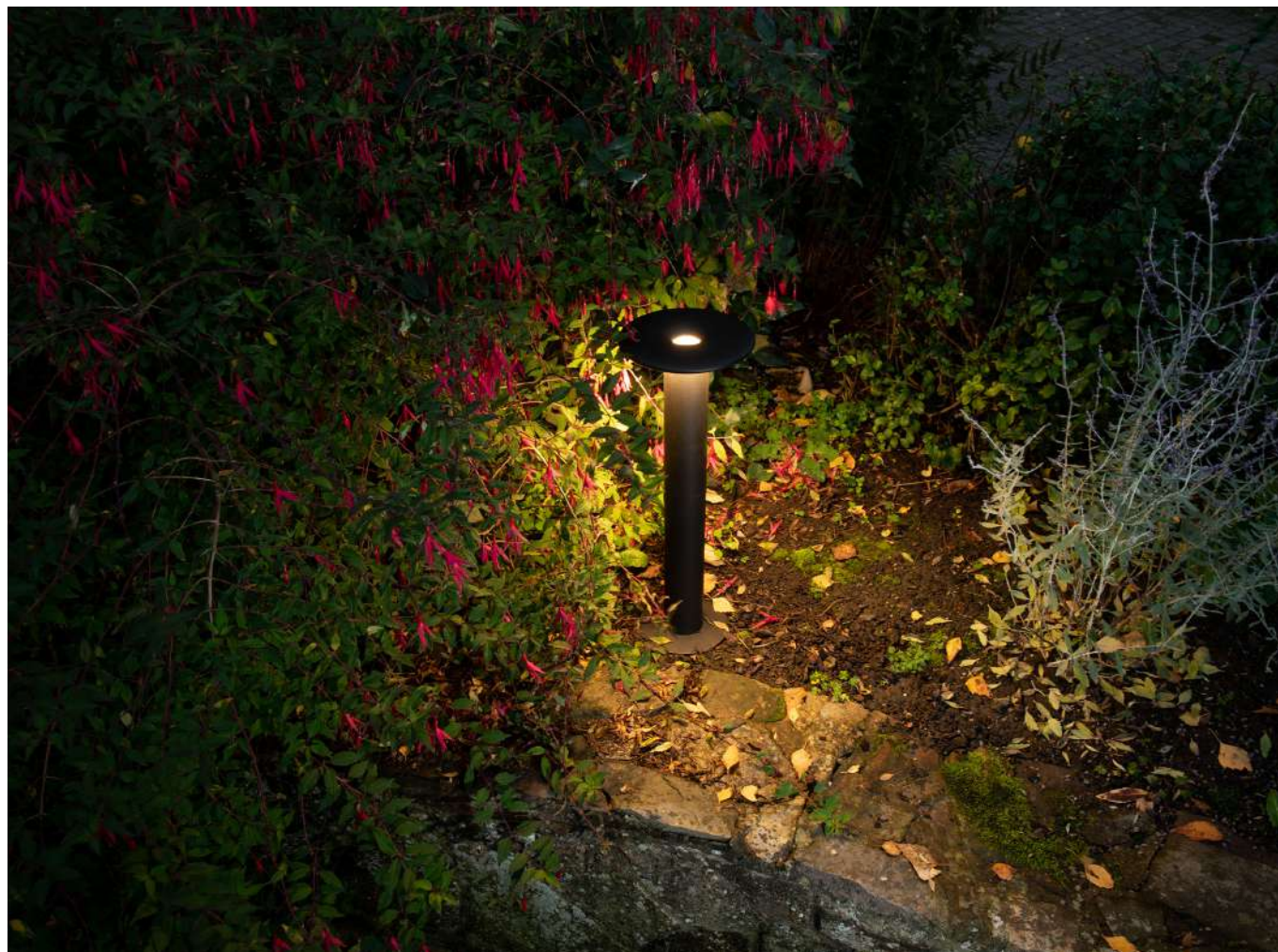



OLA 2

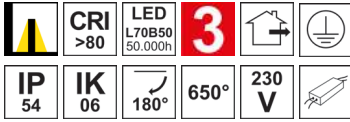

- Borne carrée pour éclairage extérieur.
- Convertisseur non dimmable intégré dans l'appareil.
- Accessoire inclus : plaque occultante amovible.

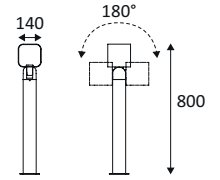

OLA 2	COULEUR	MATIÈRE	P	CCT	LED LUMEN	SYSTEM LUMEN	€
OU481WW05	■ NOIR MAT	ALUMINIUM	6W	3000K	825Lm	280Lm	227,00

DANS LA MÊME GAMME



OLA 1 PAGE 388

LUXI 100 S P



- Borne carrée pour éclairage extérieur.
- Convertisseur non dimmable intégré dans l'appareil.

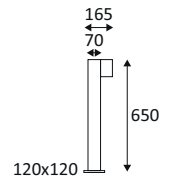

LUXI 100 S P	COULEUR	MATIÈRE	P	CCT	LED LUMEN	SYSTEM LUMEN	α	€
OU356WW24	■ ANTHRACITE	ALUMINIUM	7W	3000K	660Lm	465Lm	95°	198,00

BENS P

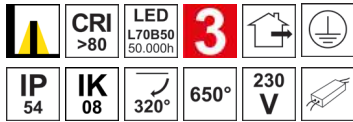

- Borne rectangulaire pour éclairage extérieur.
- Convertisseur non dimmable intégré dans l'appareil.
- Kit d'ancrage pour béton inclus.

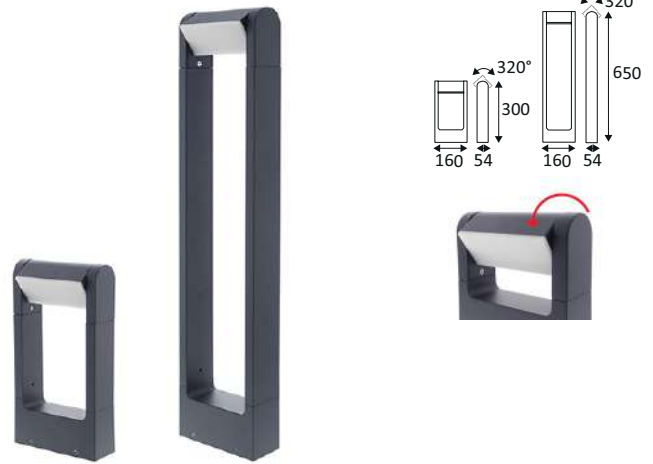

BENS P	COULEUR	MATIÈRE	P	CCT	H(MM)	LED LUMEN	SYSTEM LUMEN	α	€
OU361WW24	■ ANTHRACITE	ALUMINIUM	6W	3000K	300	600Lm	435Lm	120°	166,00
OU362WW24	■ ANTHRACITE	ALUMINIUM	6W	3000K	600	600Lm	435Lm	120°	198,00

DANS LA MÊME GAMME



BENS W PAGE 442

SETO



- Borne ronde pour éclairage extérieur.
- Ne nécessite pas de convertisseur.



SETO	COULEUR	MATIÈRE	P	CCT	LED LUMEN	SYSTEM LUMEN	α	€
OU336NW24	■ ANTHRACITE	FORTE D'ALUMINIUM	10W	4000K	970Lm	560Lm	40°	223,00



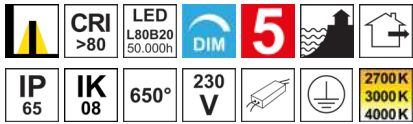

SLIM

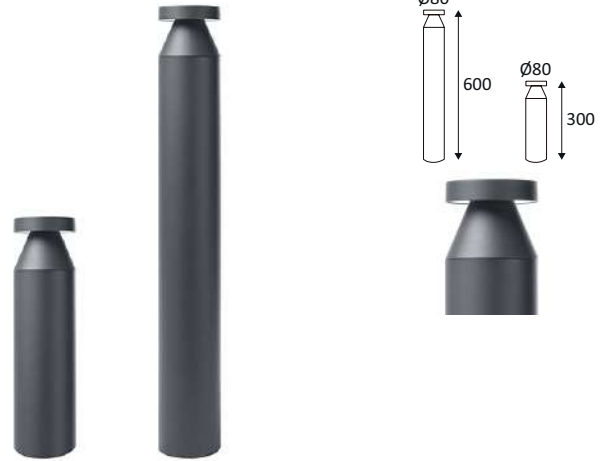

- Borne ronde pour éclairage extérieur.
- Diffuseur en verre satiné.
- 2700K, 3000K ou 4000K au choix via un interrupteur dans le luminaire.
- 2.40m de câble fourni.
- Convertisseur dimmable intégré dans l'appareil.
- Compatible avec variateur fin de phase.



SLIM	COULEUR	MATIÈRE	P	CCT	H(MM)	LED LUMEN	SYSTEM LUMEN	α	€
SM030R/2A/A	■ ANTHRACITE	FONTE D'ALUMINIUM	14W	2700K 3000K 4000K	300	1820Lm (4000K)	795Lm (4000K)	120°	205,00
SM060R/2A/A	■ ANTHRACITE	FONTE D'ALUMINIUM	14W	2700K 3000K 4000K	600	1820Lm (4000K)	795Lm (4000K)	120°	215,00
ACCESSOIRES		DESCRIPTION							€
OU48405		CONNECTEUR 2PIN IP68							11,00
OU48505		CONNECTEUR 3PIN IP68							30,00

- Design élégant et fonctionnel.
- Éclairage uniforme à 360°.
- Multi-CCT pour choisir son atmosphère.



LUXI 80



- Borne ronde pour éclairage extérieur.
- Diffuseur en polycarbonate opalin.
- Convertisseur non dimmable intégré dans l'appareil.

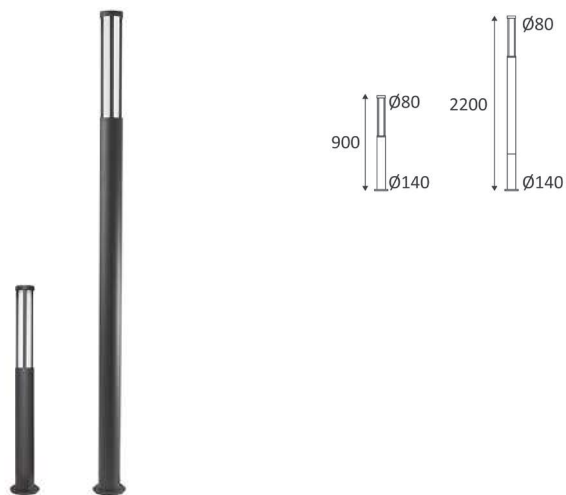

LUXI 80	COULEUR	H(MM)	MATIÈRE	P	CCT	LED LUMEN	SYSTEM LUMEN	€
OU324WW24	■ ANTHRACITE	900	FRONTE D'ALUMINIUM	18W	3000K	2340Lm	1325Lm	295,00
OU324NW24	■ ANTHRACITE	900	FRONTE D'ALUMINIUM	18W	4000K	2410Lm	1750Lm	295,00
OU325WW24	■ ANTHRACITE	2200	FRONTE D'ALUMINIUM	18W	3000K	2340Lm	1325Lm	560,00
OU325NW24	■ ANTHRACITE	2200	FRONTE D'ALUMINIUM	18W	4000K	2410Lm	1750Lm	560,00

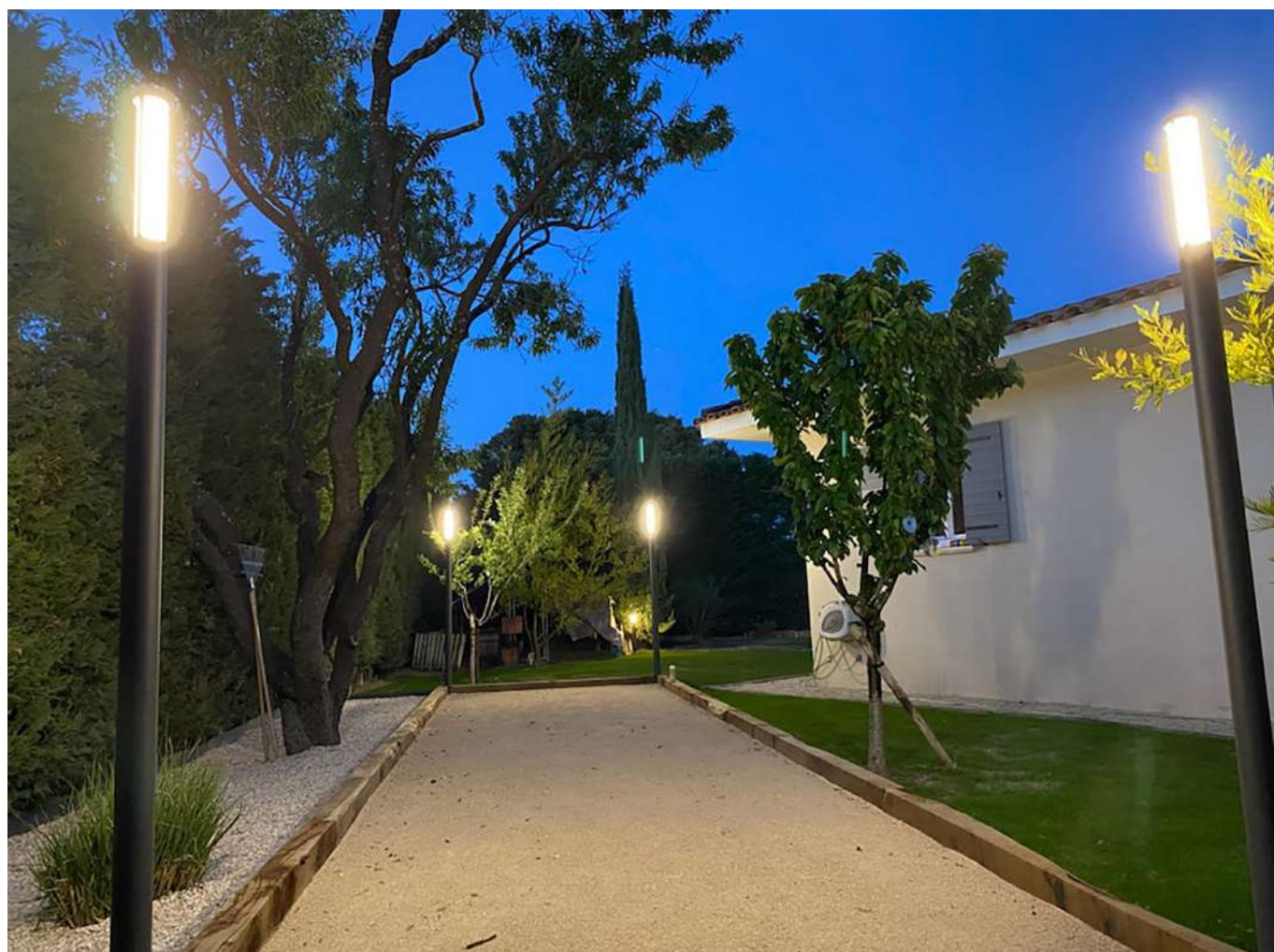



FILO P

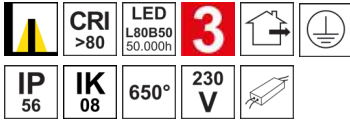

- Borne ronde pour éclairage extérieur.
- Diffuseur en polycarbonate opalin.
- Ne nécessite pas de convertisseur.

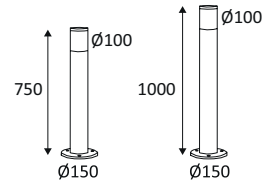

FILO P	COULEUR	MATIÈRE	P	CCT	LED LUMEN	SYSTEM LUMEN	€
OU17724	■ ANTHRACITE	FORTE D'ALUMINIUM	8W	3000K	420Lm	355Lm	310,00
OU17824	■ ANTHRACITE	FORTE D'ALUMINIUM	8W	3000K	420Lm	355Lm	340,00



HYDRA



- Borne ronde pour éclairage extérieur.
- Diffuseur en polycarbonate.
- 2200K ou 3000K au choix via un interrupteur dans le luminaire.
- Multi-puissance : 14, 19 ou 24W au choix via un interrupteur dans le luminaire.
- Tête interchangeable, fût à commander séparément.
- Convertisseur non dimmable intégré dans l'appareil.
- Avec capteur de luminosité (désactivable).
- Fonctionne uniquement quand la luminosité est inférieure à 200 Lux.
- Adapté aux zones côtières.



HYDRA	COULEUR	MATIÈRE	P	CCT	SYSTEM LUMEN	α	€
HYB1OPALWPC	NOIR MAT	ALUMINIUM	14 - 19 - 24W	2200K 3000K	2200K : 1050(14W) 1450(19W) 1750(24W) 3000K : 1200(14W) 1550(19W) 1900(24W)		235,00
HYB1CONEBPC	NOIR MAT - NOIR	ALUMINIUM	14 - 19 - 24W	2200K 3000K	2200K : 1000(14W) 1400(19W) 1700(24W) 3000K : 1150(14W) 1500(19W) 1800(24W)	145°	235,00
HYB1CONESPC	NOIR MAT - ARGENT	ALUMINIUM	14 - 19 - 24W	2200K 3000K	2200K : 1300(14W) 1800(19W) 2250(24W) 3000K : 1500(14W) 1950(19W) 2400(24W)	155°	235,00

ACCESSOIRES	COULEUR	MATIÈRE	DESCRIPTION	€
HYXBOLLARD	NOIR MAT	ALUMINIUM	FÛT + KIT DE FIXATION	165,00
HYBXSPILLKIT	NOIR MAT	ALUMINIUM	REFLECTEUR 180°	55,00

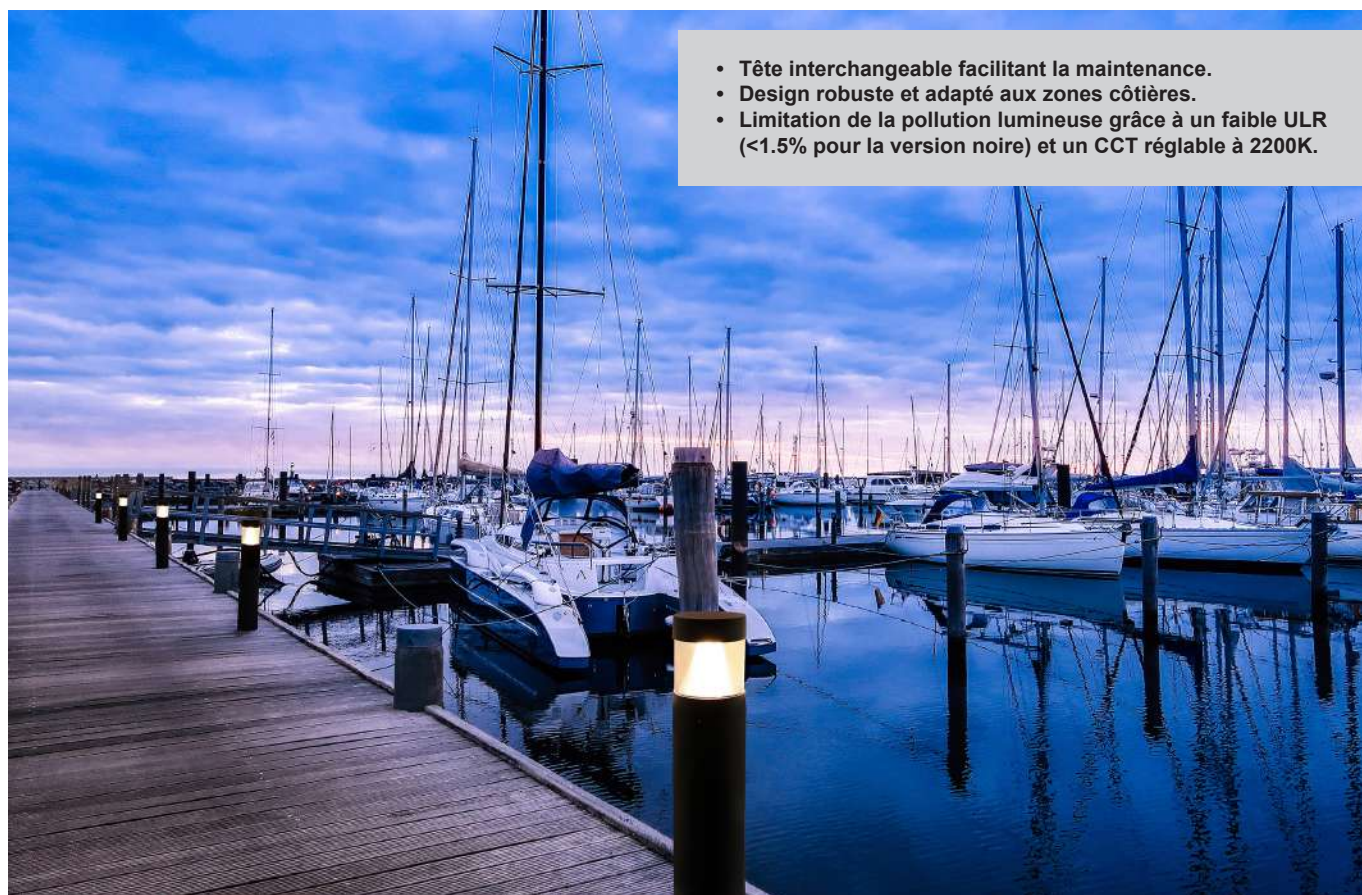

NOIR MAT

NOIR MAT - NICKEL NOIR MAT - ARGENT
BROSSÉ

- Tête interchangeable facilitant la maintenance.
- Design robuste et adapté aux zones côtières.
- Limitation de la pollution lumineuse grâce à un faible ULR (<1.5% pour la version noire) et un CCT réglable à 2200K.



AVI 1



- Borne ronde pour éclairage extérieur.
- Avec prises 2P + T 16A max. 2x2000W.
- Avec alimentations distinctes pour éclairage et prises.
- Convertisseur non dimmable intégré dans l'appareil.



AVI 1	COULEUR	MATIÈRE	P	CCT	LED LUMEN	SYSTEM LUMEN	€
OU415WW24	■ ANTHRACITE	FONTE D'ALUMINIUM	4W	3000K	475Lm	175Lm	215,00
OU415NW24	■ ANTHRACITE	FONTE D'ALUMINIUM	4W	4000K	480Lm	170Lm	215,00

AVI 2



- Borne ronde pour extérieur.
- Avec prises 2P + T 16A max. 2x2000W.

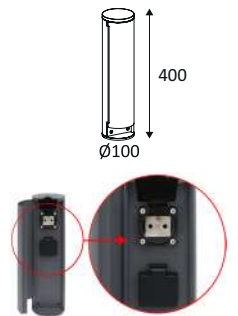

AVI 2	COULEUR	MATIÈRE	€
OU46324	■ ANTHRACITE	FONTE D'ALUMINIUM	145,00



CYCLO

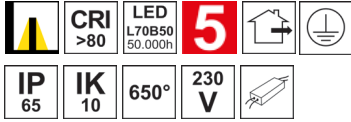

- Borne ronde pour éclairage extérieur.
- Diffuseur en polycarbonate.
- Convertisseur non dimmable intégré dans l'appareil.



CYCLO	COULEUR	MATIÈRE	P	H (MM)	CCT	LED LUMEN	SYSTEM LUMEN	€
OU515WW24	■ ANTHRACITE	FONTE D'ALUMINIUM	24W	600	3000K	2100Lm	1660Lm	465,00
OU390WW24	■ ANTHRACITE	FONTE D'ALUMINIUM	24W	955	3000K	2100Lm	1660Lm	500,00

ACCESSOIRES	COULEUR	MATIÈRE	DESCRIPTION	€
OU39224	ANTHRACITE	FONTE D'ALUMINIUM	REFLECTEUR 180°	35,00

CYCLO SENSOR

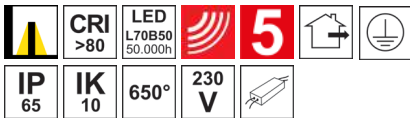

- Borne ronde pour éclairage extérieur.
- Diffuseur en polycarbonate.
- Avec détecteur IR 90°, zone de détection réglable max. 5m.
- Convertisseur non dimmable intégré dans l'appareil.



CYCLO SENSOR	COULEUR	MATIÈRE	P	CCT	H (MM)	LED LUMEN	SYSTEM LUMEN	€
OU516WW24	■ ANTHRACITE	FONTE D'ALUMINIUM	24W	3000K	600	2100Lm	1660Lm	485,00
OU391WW24	■ ANTHRACITE	FONTE D'ALUMINIUM	24W	3000K	955	2100Lm	1660Lm	520,00

ACCESSOIRES	COULEUR	MATIÈRE	DESCRIPTION	€
OU39224	ANTHRACITE	FONTE D'ALUMINIUM	REFLECTEUR 180°	35,00

CYCLO

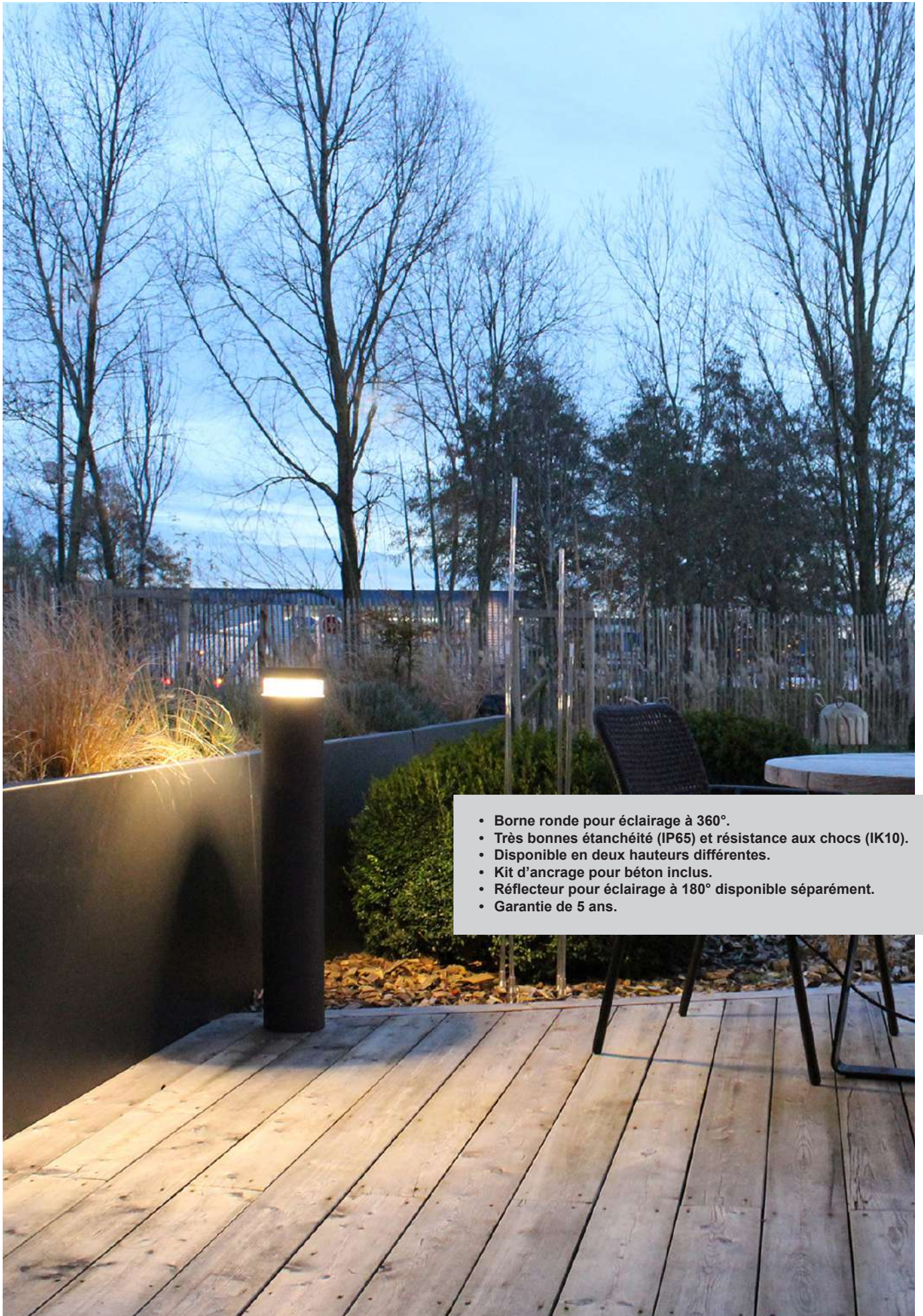

- Borne ronde pour éclairage à 360°.
- Très bonnes étanchéité (IP65) et résistance aux chocs (IK10).
- Disponible en deux hauteurs différentes.
- Kit d'ancrage pour béton inclus.
- Réflecteur pour éclairage à 180° disponible séparément.
- Garantie de 5 ans.

ENCASTRÉS MURAUX

PURE 190



- Encastré mural extérieur rectangulaire pour balisage.
- Boîtier d'encastrement fourni.
- Convertisseur non dimmable intégré dans l'appareil.

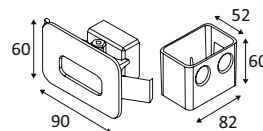

PURE 190	COULEUR	MATIÈRE	P	CCT	L(MM)	LED LUMEN	SYSTEM LUMEN	€
OU190WW24	■ ANTHRACITE	ALUMINIUM	3W	3000K	90	380Lm	150Lm	160,00
OU190WW47	■ ACIER CORTEN	ALUMINIUM	3W	3000K	90	380Lm	150Lm	160,00



ANTHRACITE

ACIER CORTEN

DEVI



- Encastré mural extérieur rectangulaire pour balisage.
- Boîtier d'encastrement fourni.
- Avec entrée et sortie de câble.
- Convertisseur non dimmable intégré dans l'appareil.

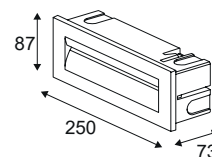

DEVI	COULEUR	MATIÈRE	P	CCT	L(MM)	LED LUMEN	SYSTEM LUMEN	€
OU350NW24	■ ANTHRACITE	ALUMINIUM	8,5W	4000K	250	500Lm	190Lm	154,00



ARTSY

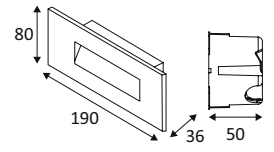
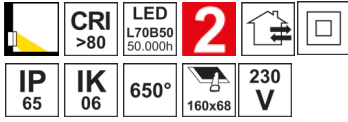

- Encastré mural extérieur rectangulaire pour balisage.
- Boîtier d'encastrement fourni.
- Ne nécessite pas de convertisseur.

ARTSY	COULEUR	MATIÈRE	P	CCT	L(MM)	LED LUMEN	SYSTEM LUMEN	α	€
OU374WW37	BLANC	POLYCARBONATE + VERRE	5W	3000K	190	480Lm	200Lm	90°	135,00

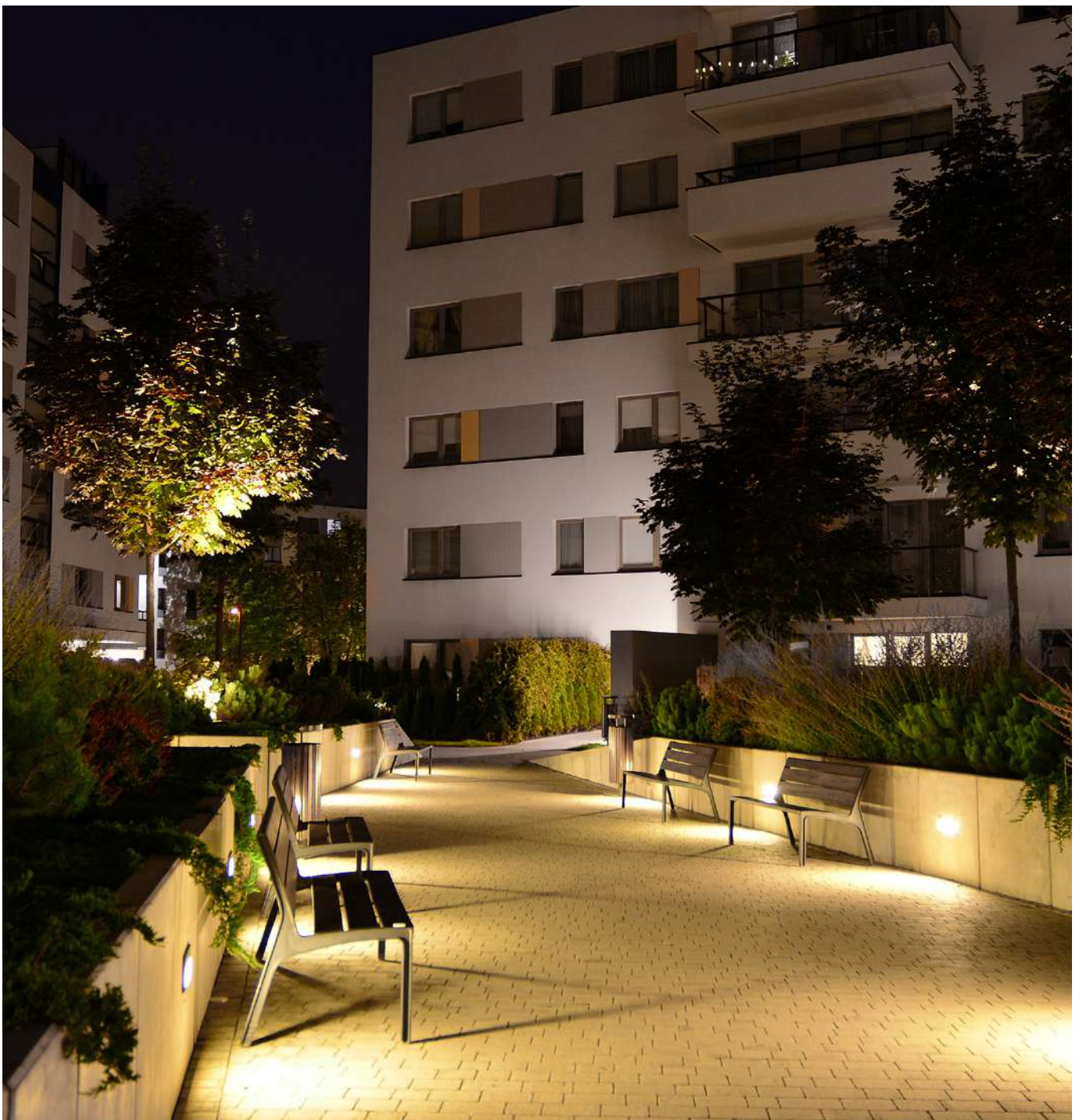

APPLIQUES

ALTEA 1 GU10

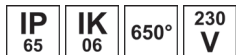

- Applique murale pour éclairage extérieur.
- Diffuseur en verre trempé clair.
- Eclairage «down».

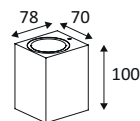

ALTEA 1 GU10	COULEUR	MATIÈRE	L(MM)	DOUILLE	LAMPE	WATT MAX	€
OU51005	■ NOIR MAT	FORTE D'ALUMINIUM	78	GU10	PAR16 LED	7W	80,00

ALTEA 2 GU10

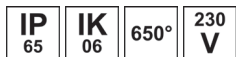

- Applique murale pour éclairage extérieur.
- Diffuseurs en verre trempé clair.
- Eclairage «up&down».
- Avec entrée et sortie de câble.

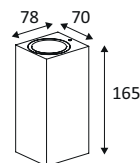

ALTEA 2 GU10	COULEUR	MATIÈRE	L(MM)	DOUILLE	LAMPE	WATT MAX	€
OU51105	■ NOIR MAT	FORTE D'ALUMINIUM	78	GU10	PAR16 LED	2X7W	90,00





APPLIQUES

ALTO 1 GU10



- Applique murale pour éclairage extérieur.
- Diffuseur en verre trempé clair.
- Eclairage «down».

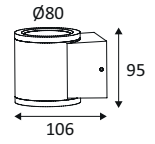

ALTO 1 GU10	COULEUR	MATIÈRE	L(MM)	DOUILLE	LAMPE	WATT MAX	€
OU50805	■ NOIR MAT	FONTE D'ALUMINIUM	106	GU10	PAR16 LED	7W	70,00

ALTO 2 GU10



- Applique murale pour éclairage extérieur.
- Diffuseurs en verre trempé clair.
- Eclairage «up&down».

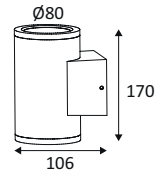

ALTO 2 GU10	COULEUR	MATIÈRE	L(MM)	DOUILLE	LAMPE	WATT MAX	€
OU50905	■ NOIR MAT	FONTE D'ALUMINIUM	106	GU10	PAR16 LED	2X7W	80,00



FURY S GU10



- Applique murale ou plafonnier pour éclairage extérieur.

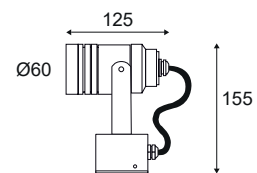

FURY S GU10	COULEUR	MATIÈRE	DOUILLE	LAMPE	WATT MAX	€
OU31024	■ ANTHRACITE	ALUMINIUM	GU10	PAR16 LED	7W	104,00

HUGO GU10



- Applique murale pour éclairage extérieur.
- Eclairage «up» ou «down».

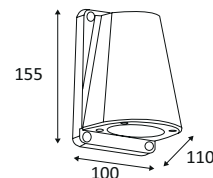

HUGO GU10	COULEUR	MATIÈRE	DOUILLE	LAMPE	WATT MAX	€
BO1360A15	■ ANTHRACITE	FORTE D'ALUMINIUM	GU10	PAR16 LED	7W	117,00

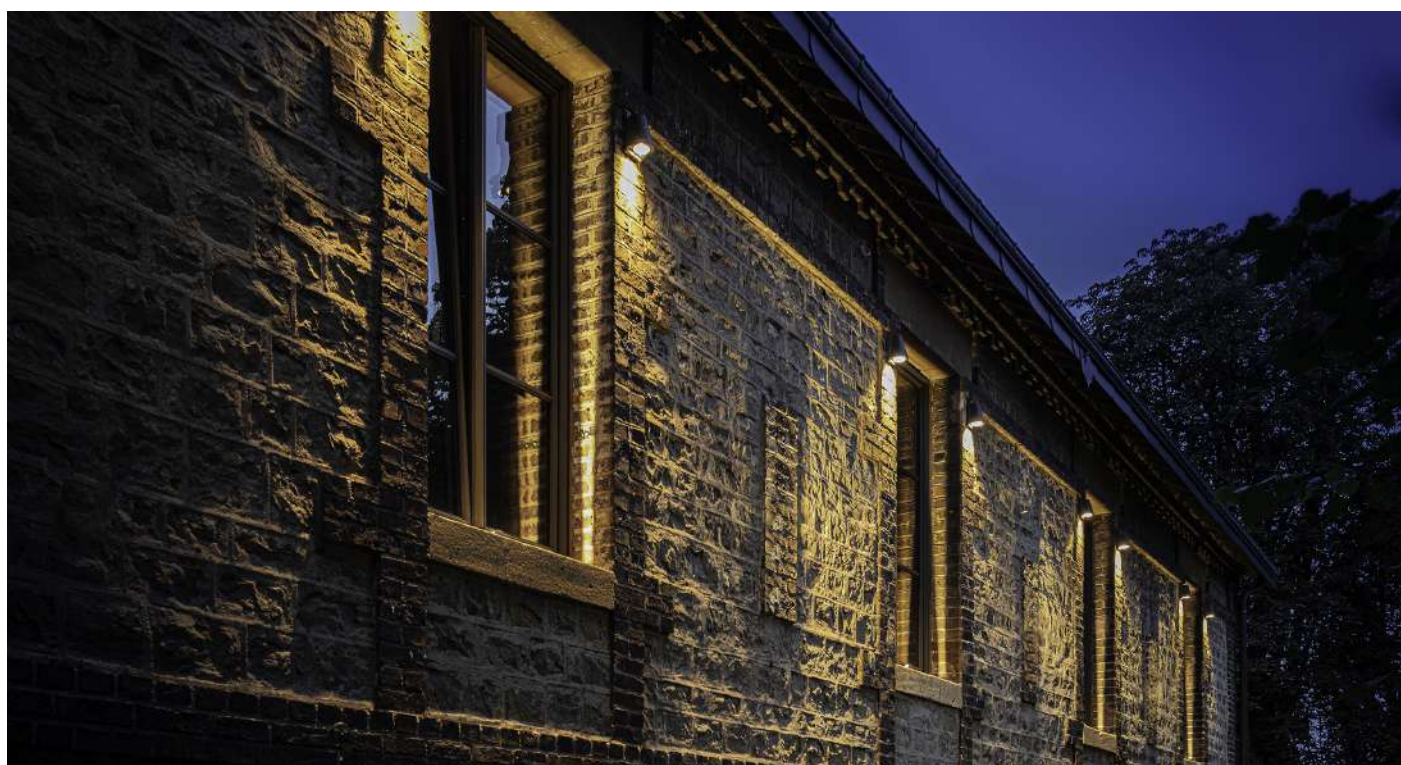



APPLIQUES

MINO W E27



- Applique murale pour éclairage extérieur.
- Diffuseur en verre dépoli.

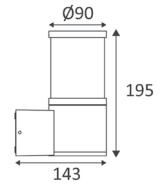

MINO W E27	COULEUR	MATIÈRE	DOUILLE	LAMPE	WATT MAX	€
OU43424	■ ANTHRACITE	FONTE D'ALUMINIUM	E27	CLASSIC A	26W	79,00

RONDO W E27



- Applique murale pour éclairage extérieur.
- Corps anthracite et diffuseur en verre clair ou opalin.

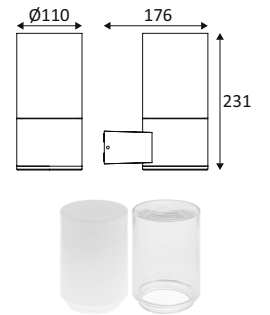

RONDO W E27	COULEUR	MATIÈRE	DOUILLE	LAMPE	WATT MAX	€
OU40724	■ ANTHRACITE + VERRE OPALIN	FONTE D'ALUMINIUM	E27	CLASSIC A	18W	122,00
OU40824	■ ANTHRACITE + VERRE CLAIR	FONTE D'ALUMINIUM	E27	CLASSIC A	18W	122,00



ANTHRACITE +
VERRE OPALIN



ANTHRACITE +
VERRE CLAIR

DANS LA MÊME GAMME

RONDO P E27 PAGE 406



KADRO E27



- Applique murale pour éclairage extérieur.
- Diffuseur en verre.
- Avec entrée et sortie de câble.

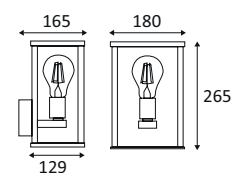

KADRO E27	COULEUR	MATIÈRE	DOUILLE	LAMPE	WATT MAX	€
OU25324	■ ANTHRACITE	ALUMINIUM	E27	CLASSIC A	8W	185,00





APPLIQUES

ELBY S

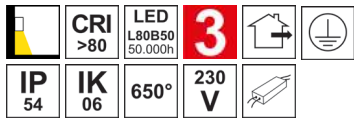

- Applique murale extérieure pour balisage.
- Convertisseur non dimmable intégré dans l'appareil.

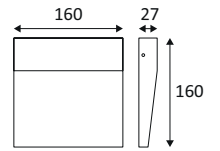

ELBY S	COULEUR	MATIÈRE	P	CCT	LED LUMEN	SYSTEM LUMEN	€
OU365WW24	ANTHRACITE	FORTE D'ALUMINIUM	3W	3000K	390Lm	295Lm	87,00



COSTE 1



- Applique murale extérieure pour balisage.
- Convertisseur non dimmable intégré dans l'appareil.

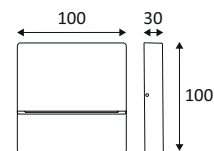

COSTE 1	COULEUR	MATIÈRE	P	CCT	LED LUMEN	SYSTEM LUMEN	α	€
OU513WW05	■ NOIR MAT	FONTE D'ALUMINIUM	4W	3000K	320Lm	175Lm	40°	62,00
OU513WW24	■ ANTHRACITE	FONTE D'ALUMINIUM	4W	3000K	320Lm	175Lm	40°	62,00



NOIR MAT



ANTHRACITE

COSTE 2



- Applique murale extérieure pour balisage.
- Avec entrée et sortie de câble.
- Convertisseur non dimmable intégré dans l'appareil.

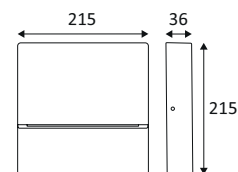

COSTE 2	COULEUR	MATIÈRE	P	CCT	LED LUMEN	SYSTEM LUMEN	α	€
OU514WW05	■ NOIR MAT	FONTE D'ALUMINIUM	8W	3000K	910Lm	295Lm	40°	107,00
OU514WW24	■ ANTHRACITE	FONTE D'ALUMINIUM	8W	3000K	910Lm	295Lm	40°	107,00



NOIR MAT



ANTHRACITE



APPLIQUES

ITO

	CRI >80	LED L80B50 50.000h	DIM	3		
IP 65	IK 02	650°	230 V			

- Applique murale extérieure pour balisage.
- Ne nécessite pas de convertisseur.
- Dimmable.

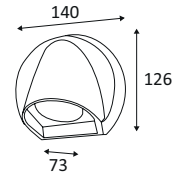

ITO	COULEUR	MATIÈRE	P	CCT	LED LUMEN	SYSTEM LUMEN	€
OU340WW24	ANTHRACITE	FONTE D'ALUMINIUM	8W	3000K	700Lm	330Lm	153,00

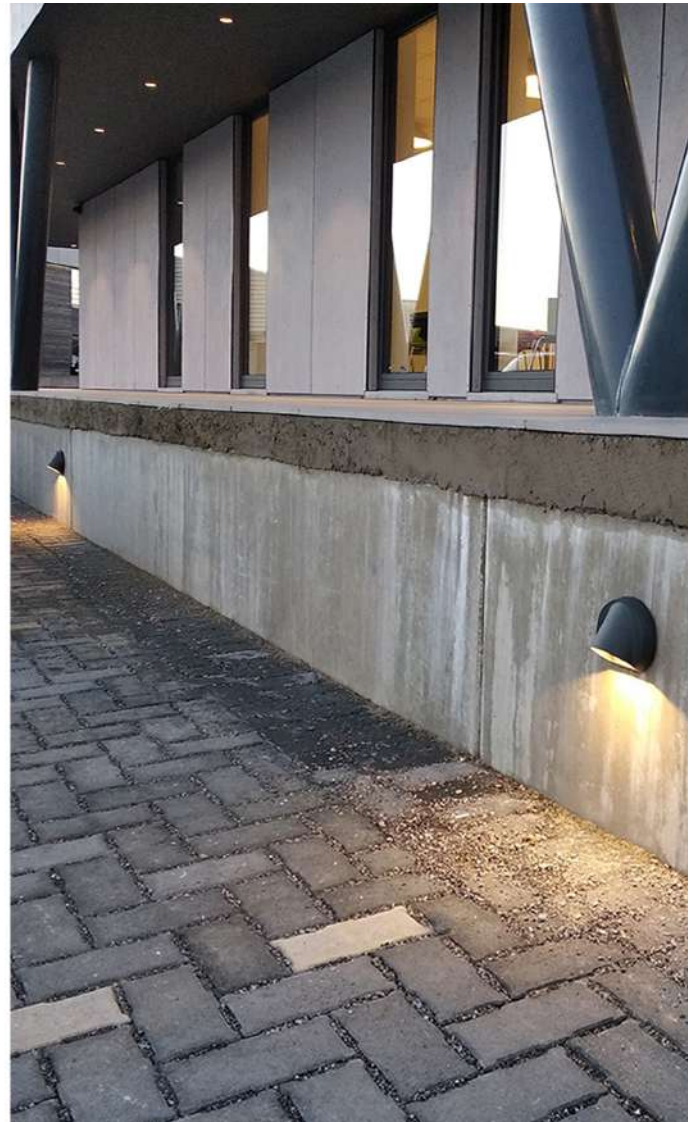

BARKO



- Applique murale décorative pour éclairage intérieur ou extérieur.
- Eclairage indirect.
- 2700K, 3000K, ou 4000K au choix via un interrupteur à l'intérieur du luminaire.
- Convertisseur non dimmable intégré dans l'appareil.

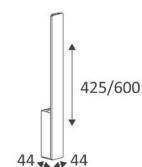

BARKO	COULEUR	MATIÈRE	P	CCT	L(MM)	LED LUMEN	SYSTEM LUMEN	α	€
OU52005	NEW NOIR MAT	ALUMINIUM	5,7W	2700K 3000K 4000K	425	590Lm (4000K)	430Lm (4000K)	110°	160,00
OU52030	NEW BLANC MAT	ALUMINIUM	5,7W	2700K 3000K 4000K	425	590Lm (4000K)	430Lm (4000K)	110°	160,00
OU52105	NEW NOIR MAT	ALUMINIUM	7W	2700K 3000K 4000K	600	820Lm (4000K)	580Lm (4000K)	110°	200,00
OU52130	NEW BLANC MAT	ALUMINIUM	7W	2700K 3000K 4000K	600	820Lm (4000K)	580Lm (4000K)	110°	200,00

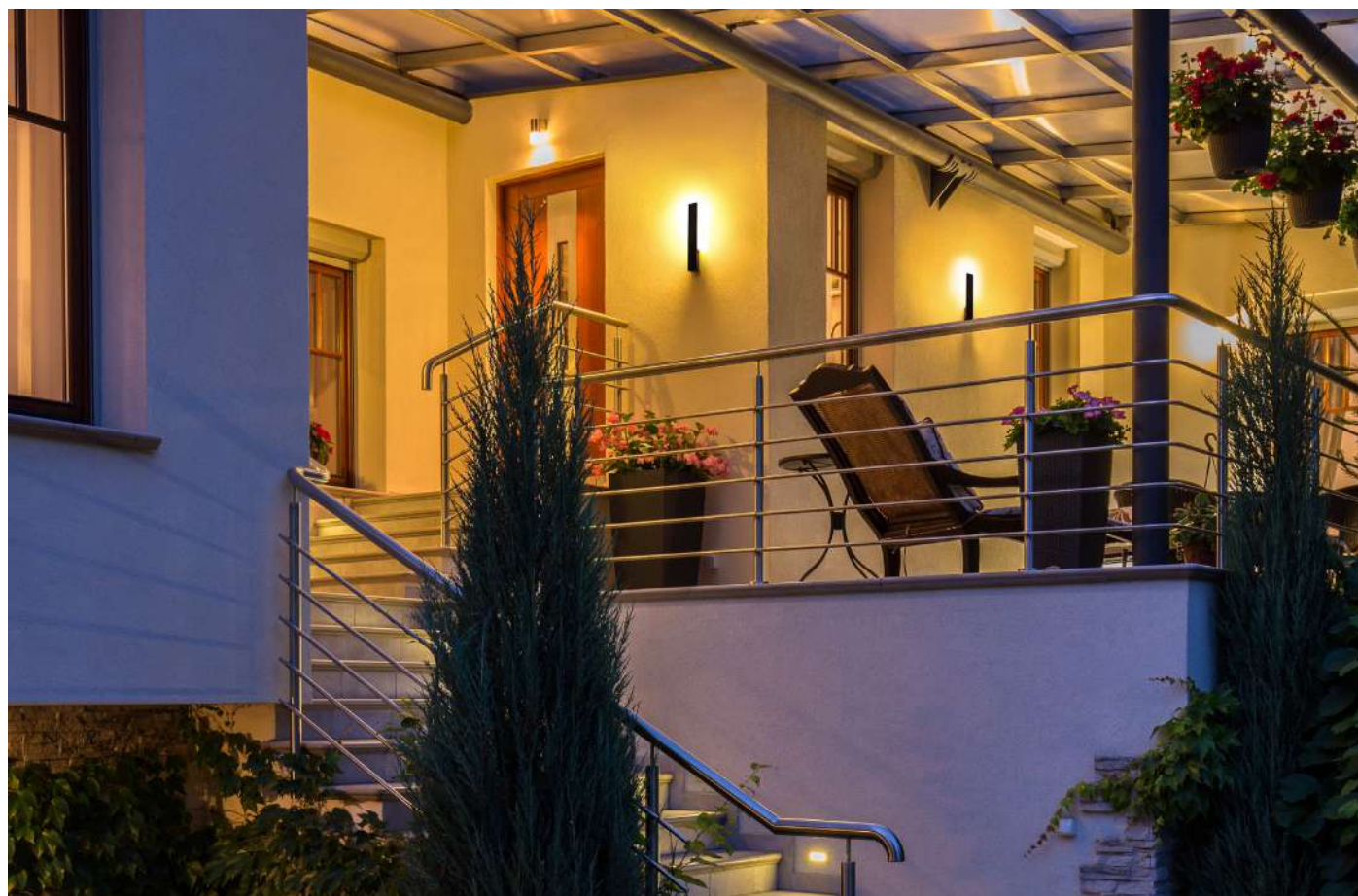
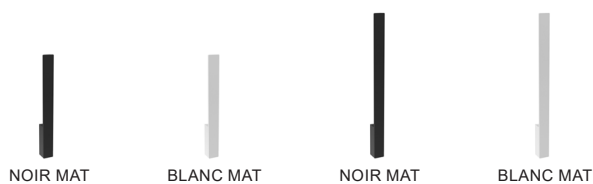

**SPOTTY 1 W**

- Applique murale pour éclairage extérieur.
- Eclairage «up» ou «down».
- Convertisseur non dimmable intégré dans l'appareil.

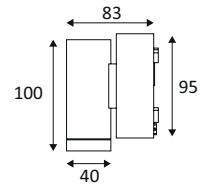

SPOTTY 1 W	COULEUR	MATIÈRE	P	CCT	LED LUMEN	SYSTEM LUMEN	α	€
PT05/1A/3K/A	■ ANTHRACITE	ALUMINIUM	6W	3000K	600Lm	400Lm	30°	175,00

DANS LA MÊME GAMME

SPOTTY 1 P PAGE 392

SPOTTY 2 P PAGE 393

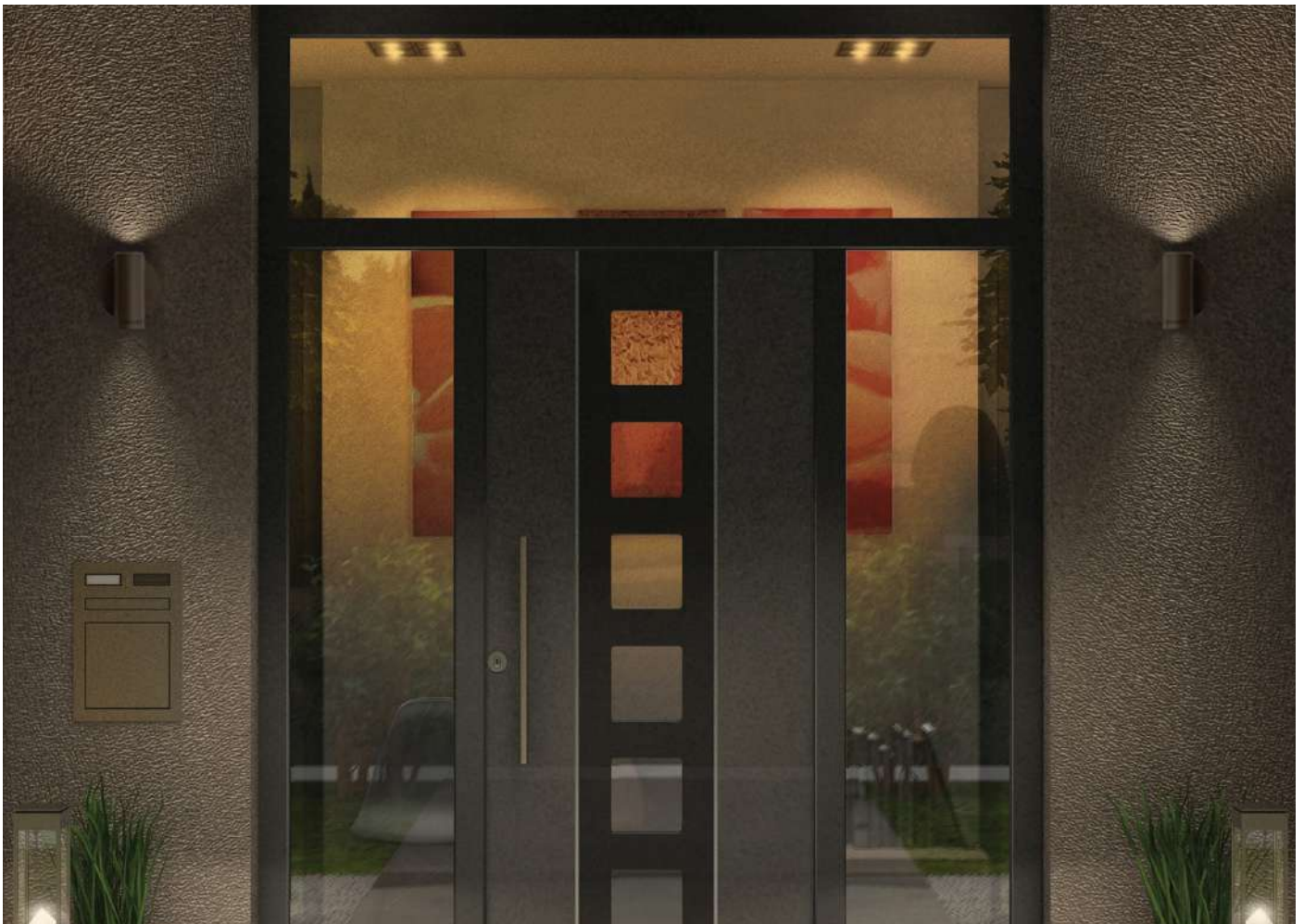

SPOTTY 2 W



- Applique murale pour éclairage extérieur.
- Eclairage «up & down».
- Convertisseur non dimmable intégré dans l'appareil.

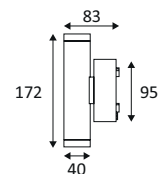

SPOTTY 2 W	COULEUR	MATIÈRE	P	CCT	LED LUMEN	SYSTEM LUMEN	α	€
PT05/2A/3K/A	■ ANTHRACITE	ALUMINIUM	11,5W	3000K	2X600Lm	800Lm	30°	215,00

DANS LA MÊME GAMME

SPOTTY 1 P PAGE 392

SPOTTY 2 P PAGE 393

SPOTTY 3 W



- Applique murale orientable pour éclairage extérieur.
- Convertisseur non dimmable intégré dans l'appareil.

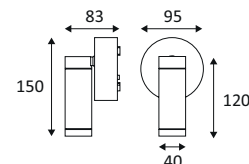

SPOTTY 3 W	COULEUR	MATIÈRE	P	CCT	L(MM)	LED LUMEN	SYSTEM LUMEN	α	€
PT05/M/3K/A	■ ANTHRACITE	ALUMINIUM	6W	3000K	83	600Lm	400Lm	30°	200,00

DANS LA MÊME GAMME

SPOTTY 1 P PAGE 392

SPOTTY 2 P PAGE 393

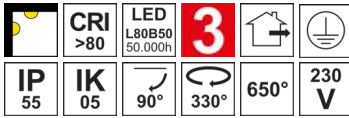
**GUNZY S**

- Applique murale ou plafonnier pour éclairage extérieur.
- Base apparente avec entrée et sortie de câble.
- Ne nécessite pas de convertisseur.
- Non dimmable.

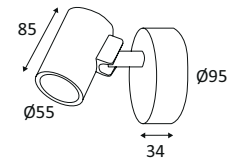

GUNZY S	COULEUR	MATIÈRE	P	CCT	LED LUMEN	SYSTEM LUMEN	α	€
OU18524	■ ANTHRACITE	FONTE D'ALUMINIUM	8W	3000K	760Lm	500Lm	38°	190,00

DANS LA MÊME GAMME

GUNZY PAGE 394



GUNZY P PAGE 395



GUNZY 2 S PAGE 441



GUNZY 2 P PAGE 396

GUNZY 2 S

- Applique murale pour éclairage extérieur.
- Base apparente avec entrée et sortie de câble.
- Ne nécessite pas de convertisseur.
- Non dimmable.

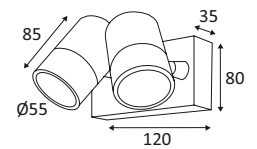

GUNZY 2 S	COULEUR	MATIÈRE	P	CCT	LED LUMEN	SYSTEM LUMEN	α	€
OU18624	■ ANTHRACITE	FONTE D'ALUMINIUM	16W	3000K	2X760Lm	925Lm	38°	350,00

DANS LA MÊME GAMME

GUNZY PAGE 394



GUNZY P PAGE 395



GUNZY 2 P PAGE 396



GUNZY S PAGE 441

BENS W

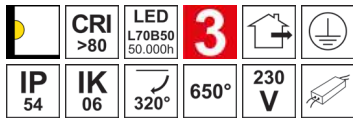

- Applique murale pour éclairage extérieur.
- Convertisseur non dimmable intégré dans l'appareil.

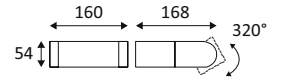

BENS W	COULEUR	MATIÈRE	P	CCT	LED LUMEN	SYSTEM LUMEN	α	€
OU360WW24	■ ANTHRACITE	FONTE D'ALUMINIUM	6W	3000K	600Lm	435Lm	120°	158,00

DANS LA MÊME GAMME



BENS P PAGE 416

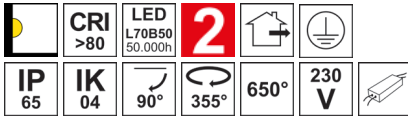

**ARCOLE**

- Applique murale pour éclairage extérieur.
- Base apparente avec entrée et sortie de câble.
- Faisceau ajustable de 18° à 60°.
- Convertisseur non dimmable intégré dans l'appareil.

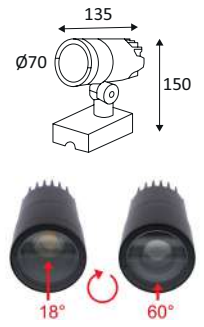

ARCOLE	COULEUR	MATIÈRE	P	CCT	LED LUMEN	SYSTEM LUMEN	α	€
OU375WW24	■ ANTHRACITE	FONTE D'ALUMINIUM	8W	3000K	800Lm	455Lm	18-60°	221,00

DANI

- Applique murale pour éclairage extérieur.
- Base apparente avec entrée et sortie de câble.
- Eclairage «up&down».
- Convertisseur non dimmable intégré dans l'appareil.

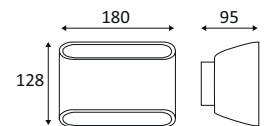

DANI	COULEUR	MATIÈRE	P	CCT	LED LUMEN	SYSTEM LUMEN	€
OU15024	■ ANTHRACITE	FONTE D'ALUMINIUM	10W	3000K	2X500Lm	590Lm	300,00

LUXI 45

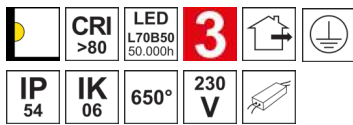

- Applique murale pour éclairage extérieur.
- Diffuseur en polycarbonate opalin.
- Convertisseur non dimmable intégré dans l'appareil.

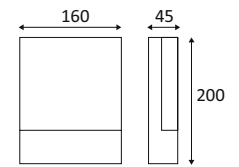

LUXI 45	COULEUR	MATIÈRE	P	CCT	LED LUMEN	SYSTEM LUMEN	α	€
OU20624	■ ANTHRACITE	ALUMINIUM	6W	3000K	660Lm	555Lm	120°	150,00

LUXI 45 SENSOR

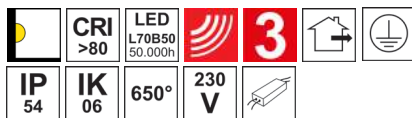

- Applique murale pour éclairage extérieur.
- Avec détecteur IR 120°, zone de détection réglable max. 6m.
- Diffuseur en polycarbonate opalin.
- Convertisseur non dimmable intégré dans l'appareil.

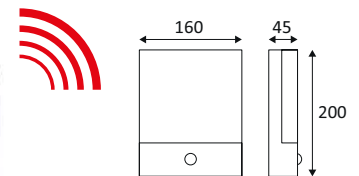

LUXI 45 SENSOR	COULEUR	MATIÈRE	P	CCT	LED LUMEN	SYSTEM LUMEN	α	€
OU359WW24	■ ANTHRACITE	ALUMINIUM	6W	3000K	660Lm	555Lm	120°	170,00



LUXI 175 SENSOR

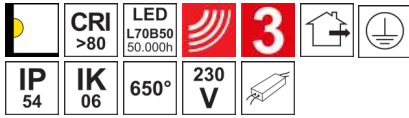

- Applique murale pour éclairage extérieur.
- Avec détecteur HF 120°, zone de détection réglable max. 8m.
- Diffuseur en polycarbonate opalin.
- Convertisseur non dimmable intégré dans l'appareil.



LUXI 175 SENSOR	COULEUR	MATIÈRE	P	CCT	LED LUMEN	SYSTEM LUMEN	α	€
OU323WW24	■ ANTHRACITE	ALUMINIUM	9W	3000K	1260Lm	760Lm	105°	230,00
OU323WW30	■ BLANC	ALUMINIUM	9W	3000K	1260Lm	950Lm	105°	230,00
OU323NW24	■ ANTHRACITE	ALUMINIUM	9W	4000K	1300Lm	785Lm	105°	230,00
OU323NW30	■ BLANC	ALUMINIUM	9W	4000K	1300Lm	980Lm	105°	230,00



ANTHRACITE



BLANC

DANS LA MÊME GAMME



LUXI 175 SENSOR P PAGE 411



LUXI 120 S

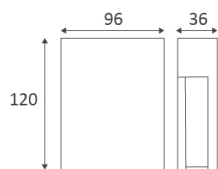

- Applique murale extérieure pour balisage.
- Diffuseur en polycarbonate.
- Convertisseur non dimmable intégré dans l'appareil.

LUXI 120 S	COULEUR	MATIÈRE	P	CCT	LED LUMEN	SYSTEM LUMEN	α	€
OU14624	■ ANTHRACITE	FONTE D'ALUMINIUM	3W	3000K	320Lm	215Lm	170°	93,00

LUXI 139

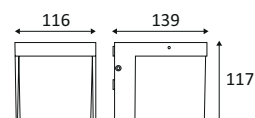

- Applique murale pour éclairage extérieur.
- Diffuseur en polycarbonate opalin.
- Convertisseur non dimmable intégré dans l'appareil.

LUXI 139	COULEUR	MATIÈRE	P	CCT	LED LUMEN	SYSTEM LUMEN	α	€
OU13524	■ ANTHRACITE	FONTE D'ALUMINIUM	3,8W	3000K	400Lm	315Lm	110°	100,00

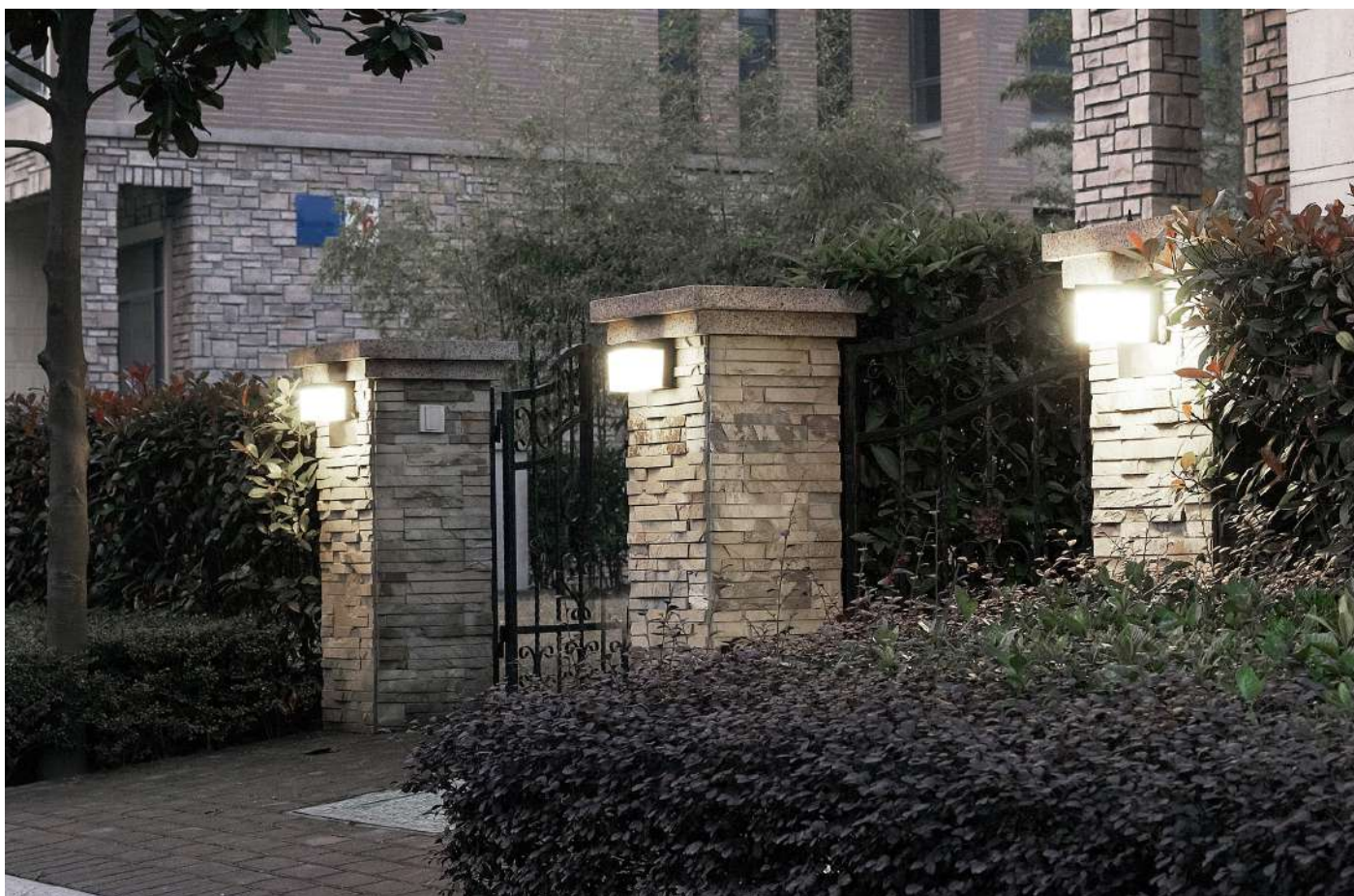



APPLIQUES

EDGY

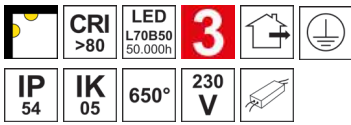

- Applique murale ou plafonnier pour éclairage extérieur.
- Diffuseur en polycarbonate opalin.
- Avec entrée et sortie de câble.
- Convertisseur non dimmable intégré dans l'appareil.

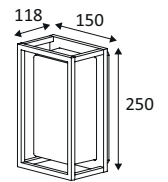

EDGY	COULEUR	MATIÈRE	P	CCT	LED LUMEN	SYSTEM LUMEN	α	€
OU467WW24	■ ANTHRACITE	FORTE D'ALUMINIUM	15W	3000K	1730Lm	950Lm	120°	160,00

LANTERN



- Applique murale pour éclairage extérieur.
- Diffuseur en polycarbonate opalin.
- Ne nécessite pas de convertisseur.
- Non dimmable.

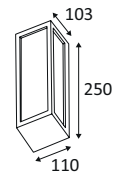

LANTERN	COULEUR	MATIÈRE	P	CCT	LED LUMEN	SYSTEM LUMEN	α	€
OU344WW24	■ ANTHRACITE	FORTE D'ALUMINIUM	18W	3000K	1500Lm	845Lm	110°	135,00

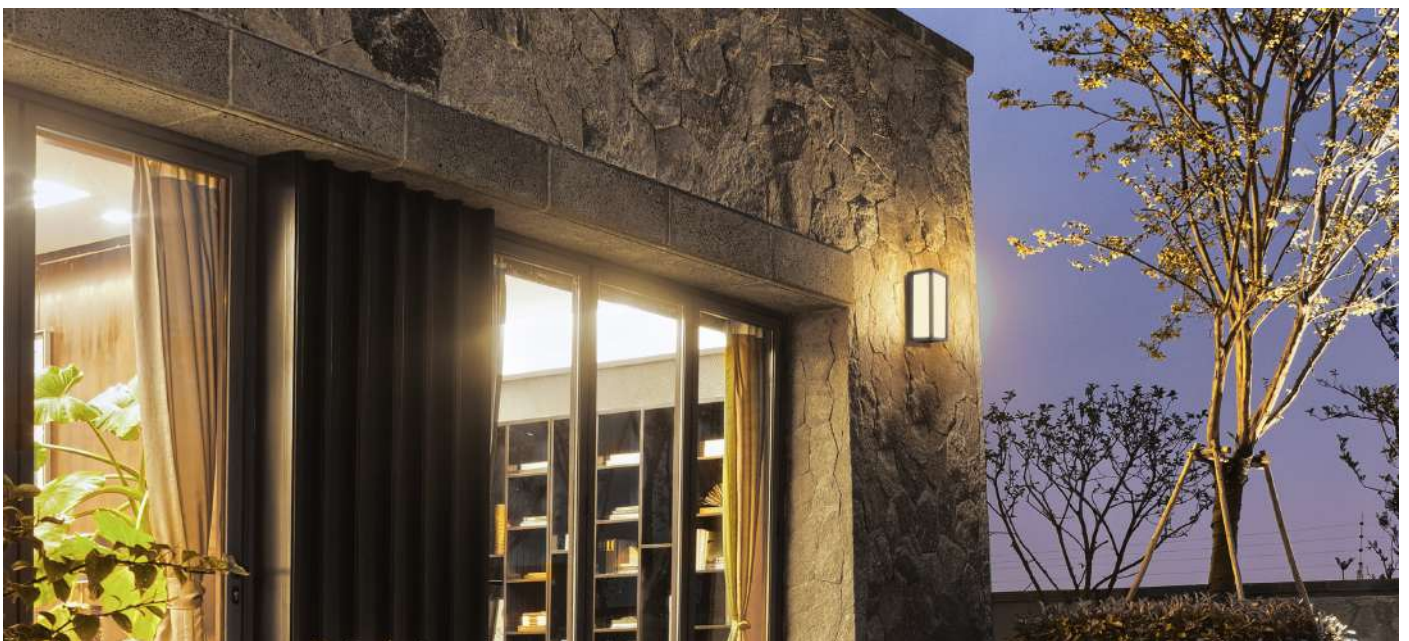

LUXI 190



- Applique murale pour éclairage extérieur.
- Eclairage «up» ou «down».
- Convertisseur non dimmable intégré dans l'appareil.

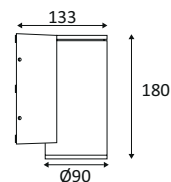

LUXI 190	COULEUR	MATIÈRE	P	CCT	LED LUMEN	SYSTEM LUMEN	α	€
OU10524	■ ANTHRACITE	FONTE D'ALUMINIUM	12W	3000K	850Lm	585Lm	65°	190,00

LUXI 290



- Applique murale pour éclairage extérieur.
- Eclairage «up&down».
- Convertisseur non dimmable intégré dans l'appareil.

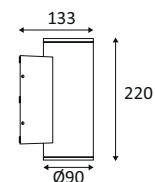

LUXI 290	COULEUR	MATIÈRE	P	CCT	LED LUMEN	SYSTEM LUMEN	α	€
OU10624	■ ANTHRACITE	FONTE D'ALUMINIUM	24W	3000K	2X850Lm	1170Lm	65°	280,00

LUXI 95



- Applique murale pour éclairage extérieur.
- Eclairage «up&down».
- Convertisseur non dimmable intégré dans l'appareil.

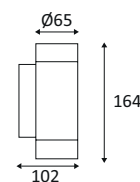

LUXI 95	COULEUR	MATIÈRE	P	CCT	LED LUMEN	SYSTEM LUMEN	α	€
OU14424	■ ANTHRACITE	FONTE D'ALUMINIUM	6W	3000K	2X220Lm	380Lm	90°	160,00

**CHERA**

- Applique murale pour éclairage extérieur.
- Eclairage «up&down».
- Convertisseur non dimmable intégré dans l'appareil.

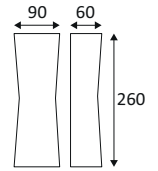

CHERA	COULEUR	MATIÈRE	P	CCT	LED LUMEN	SYSTEM LUMEN	α	€
OU363WW24	■ ANTHRACITE	FORTE D'ALUMINIUM	12W	3000K	2X680Lm	890Lm	90°	145,00

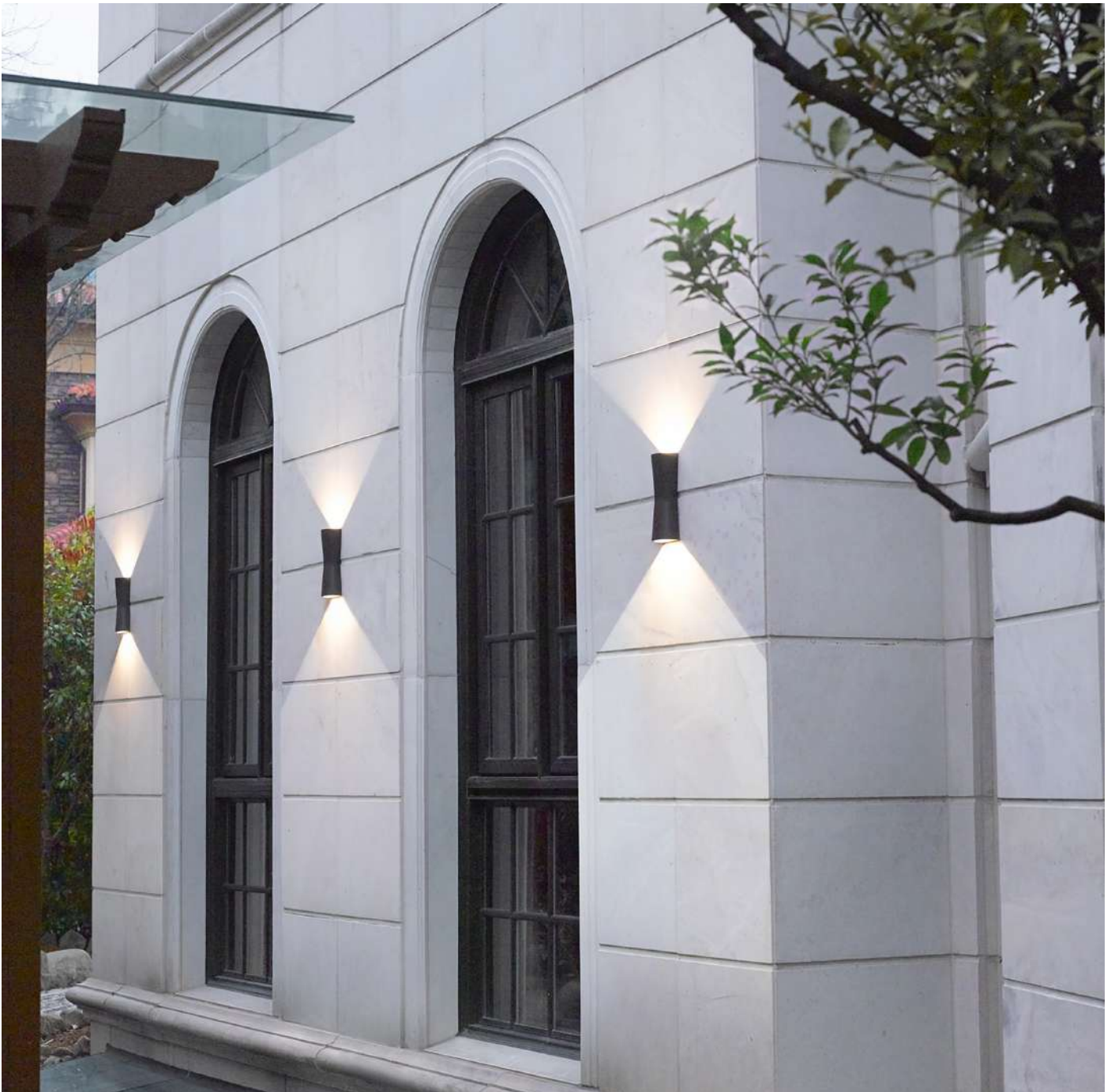

ALMA R



- Applique murale pour éclairage extérieur.
- Eclairage «up&down».
- Convertisseur non dimmable intégré dans l'appareil.

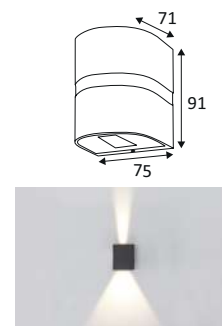

ALMA R	COULEUR	MATIÈRE	P	CCT	LED LUMEN	SYSTEM LUMEN	α	€
OU431WW24	■ ANTHRACITE	FONTE D'ALUMINIUM	6W	3000K	200Lm	135Lm	40°	76,00

ALMA S



- Applique murale pour éclairage extérieur.
- Eclairage «up&down».
- Convertisseur non dimmable intégré dans l'appareil.

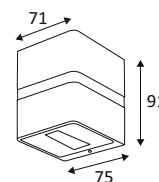

ALMA S	COULEUR	MATIÈRE	P	CCT	LED LUMEN	SYSTEM LUMEN	α	€
OU387WW24	■ ANTHRACITE	FONTE D'ALUMINIUM	6W	3000K	200Lm	135Lm	40°	86,00



ALMA R

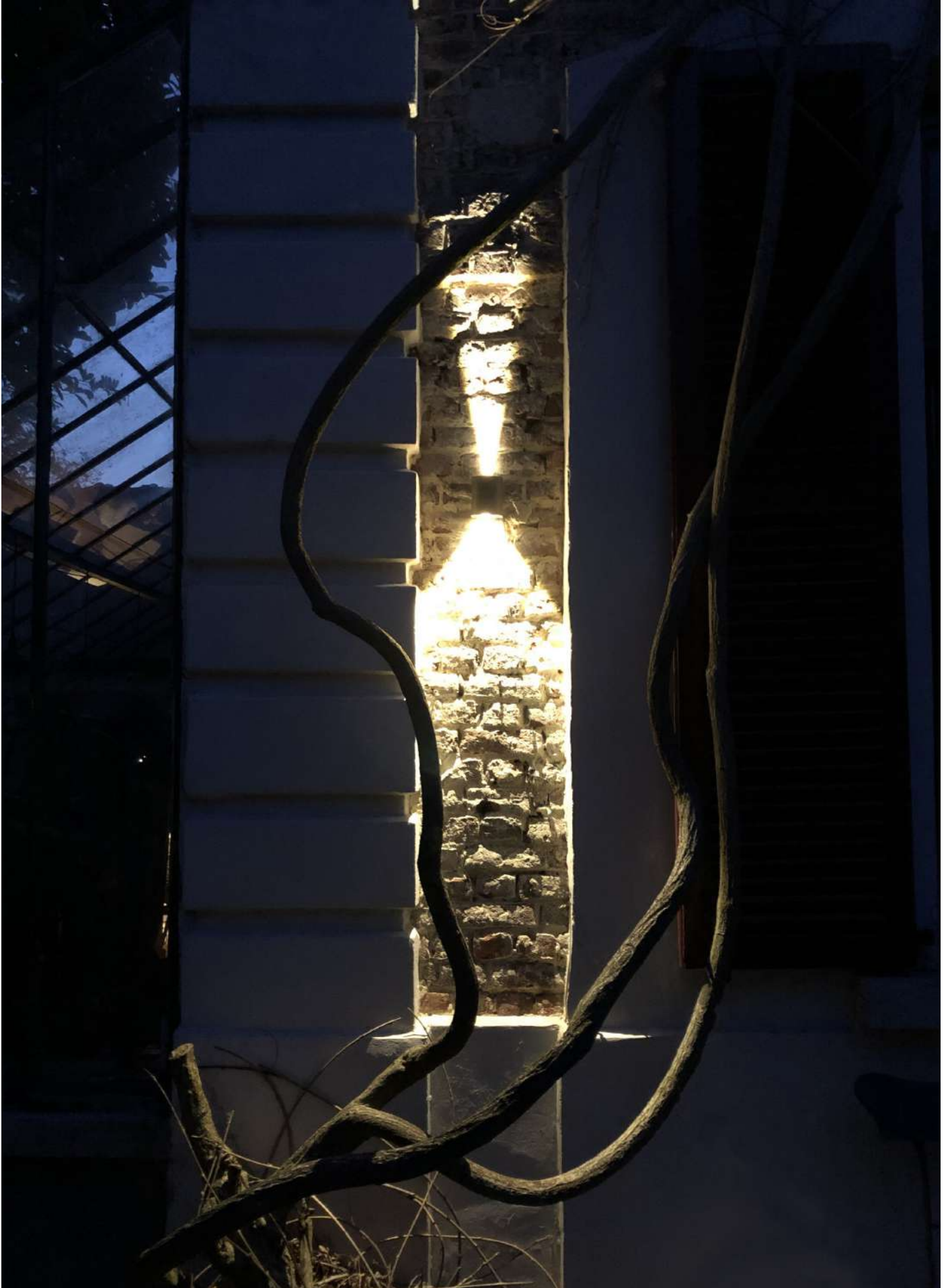

KOPA



- Applique murale pour éclairage extérieur.
- Eclairage «up&down».
- Convertisseur non dimmable intégré dans l'appareil.

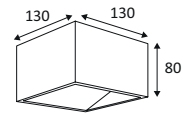

KOPA	COULEUR	MATIÈRE	P	CCT	LED LUMEN	SYSTEM LUMEN	€
OU438WW24	■ ANTHRACITE	FONTE D'ALUMINIUM	9W	3000K	695Lm	620Lm	265,00

ACCESSOIRES	COULEUR	MATIÈRE	DESCRIPTION	L(MM)	€
OU43924	ANTHRACITE	ALUMINIUM	COUVERCLE LAME DE LUMIERE	130	■ 37,00





APPLIQUES

KUBO



- Applique murale pour éclairage extérieur.
- Eclairage «up&down».
- Convertisseur non dimmable intégré dans l'appareil.

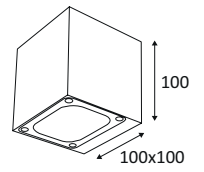

KUBO	COULEUR	MATIÈRE	P	CCT	LED LUMEN	SYSTEM LUMEN	α	€
OU334WW24	■ ANTHRACITE	FONTE D'ALUMINIUM	12W	3000K	2X500Lm	775Lm	30°	138,00



KOS 1 S



- Applique murale pour éclairage extérieur.
- Diffuseur en verre.
- Eclairage «up» ou «down».
- Avec entrée et sortie de câble.
- Convertisseur non dimmable intégré dans l'appareil.

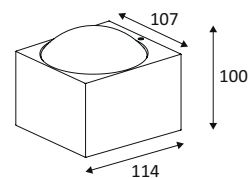

KOS 1 S	COULEUR	MATIÈRE	P	CCT	LED LUMEN	SYSTEM LUMEN	α	€
OU477WW24	■ ANTHRACITE	FONTE D'ALUMINIUM	6W	3000K	750Lm	675Lm	80°	195,00

KOS 2 R



- Applique murale pour éclairage extérieur.
- Diffuseurs en verre.
- Eclairage «up&down».
- Avec entrée et sortie de câble.
- Convertisseur non dimmable intégré dans l'appareil.

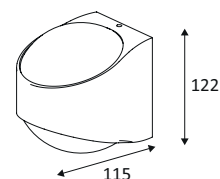

KOS 2 R	COULEUR	MATIÈRE	P	CCT	LED LUMEN	SYSTEM LUMEN	α	€
OU479WW24	■ ANTHRACITE	FONTE D'ALUMINIUM	12W	3000K	2X685Lm	1150Lm	80°	235,00



APPLIQUES

KOS 2 S

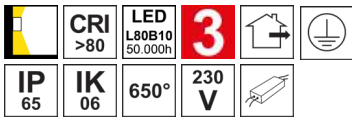

- Applique murale pour éclairage extérieur.
- Diffuseurs en verre.
- Eclairage «up&down».
- Avec entrée et sortie de câble.
- Convertisseur non dimmable intégré dans l'appareil.

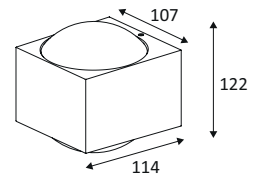

KOS 2 S	COULEUR	MATIÈRE	P	CCT	LED LUMEN	SYSTEM LUMEN	α	€
OU478WW24	■ ANTHRACITE	FONTE D'ALUMINIUM	12W	3000K	2X685Lm	1150Lm	80°	245.00

KOS 2 R



NORA

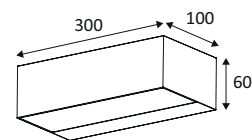
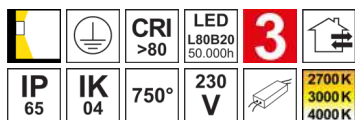

- Applique murale pour éclairage extérieur.
- 2700K, 3000K ou 4000K au choix via un interrupteur dans le luminaire.
- Diffuseurs en verre trempé dépoli.
- Eclairage «up&down».
- Avec entrée et sortie de câble.
- Convertisseur non dimmable intégré dans l'appareil.



NORA	COULEUR	MATIÈRE	P	CCT	LED LUMEN	SYSTEM LUMEN	€
OU49205	■ NOIR MAT	ALUMINIUM	15W	2700K 3000K 4000K	2100Lm (4000K)	1070Lm (4000K)	160,00

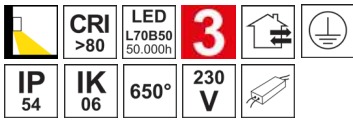

**HARRY A**

- Applique murale pour éclairage extérieur.
- Eclairage «down».
- Faisceau asymétrique.
- Avec entrée et sortie de câble.
- Convertisseur non dimmable intégré dans l'appareil.

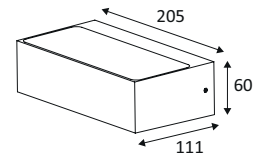

HARRY A	COULEUR	MATIÈRE	P	CCT	LED LUMEN	SYSTEM LUMEN	α	€
OU501WW05	■ NOIR MAT	ALUMINIUM	16W	3000K	1370Lm	1005Lm	60°	215,00
OU501NW05	■ NOIR MAT	ALUMINIUM	16W	4000K	1370Lm	1125Lm	60°	215,00



APPLIQUES

RUBYX R



- Applique murale pour éclairage extérieur ou intérieur.
- Eclairage «up&down».
- Sources activables individuellement via un interrupteur dans le luminaire.
- Faisceaux réglables via un système de volets.
- CCT (2200K, 2700K, 3000K ou 4000K) et puissance (8, 12, 16 ou 20W) au choix via des interrupteurs dans le luminaire.
- Avec capteur crépusculaire (activable via un interrupteur dans le luminaire) pour n'activer le luminaire que lorsque la luminosité est inférieure à 35 Lux.
- Convertisseur non dimmable intégré dans l'appareil.

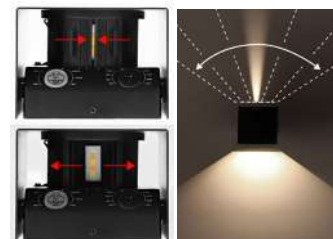
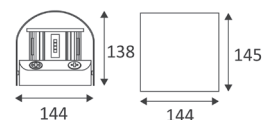

RUBYX R	COULEUR	MATIÈRE	P	CCT	LED LUMEN	SYSTEM LUMEN	α	€
OU52305 NEW	NOIR MAT	FONTE D'ALUMINIUM	8W-12W-16W-20W	2200K 2700K 3000K 4000K	3340Lm (4000K)	1500Lm (4000K)	0-100°	220,00
OU52330 NEW	BLANC MAT	FONTE D'ALUMINIUM	8W-12W-16W-20W	2200K 2700K 3000K 4000K	3340Lm (4000K)	1500Lm (4000K)	0-100°	220,00
OU52347 NEW	ACIER CORTEN	FONTE D'ALUMINIUM	8W-12W-16W-20W	2200K 2700K 3000K 4000K	3340Lm (4000K)	1500Lm (4000K)	0-100°	220,00



NOIR MAT



BLANC MAT



ACIER CORTEN

RUBYX S



- Applique murale pour éclairage extérieur ou intérieur.
- Eclairage «up&down».
- Sources activables individuellement via un interrupteur dans le luminaire.
- Faisceaux réglables via un système de volets.
- CCT (2200K, 2700K, 3000K ou 4000K) et puissance (8, 12, 16 ou 20W) au choix via des interrupteurs dans le luminaire.
- Avec capteur crépusculaire (activable via un interrupteur dans le luminaire) pour n'activer le luminaire que lorsque la luminosité est inférieure à 35 Lux.
- Convertisseur non dimmable intégré dans l'appareil.

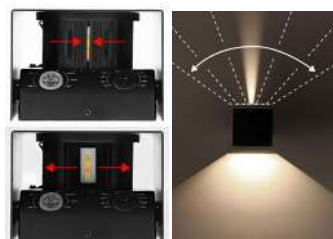
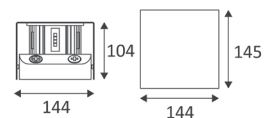

RUBYX S	COULEUR	MATIÈRE	P	CCT	LED LUMEN	SYSTEM LUMEN	α	€
OU52205 NEW	NOIR MAT	FONTE D'ALUMINIUM	8W-12W-16W-20W	2200K 2700K 3000K 4000K	3340Lm (4000K)	1500Lm (4000K)	0-100°	220,00
OU52230 NEW	BLANC MAT	FONTE D'ALUMINIUM	8W-12W-16W-20W	2200K 2700K 3000K 4000K	3340Lm (4000K)	1500Lm (4000K)	0-100°	220,00
OU52247 NEW	ACIER CORTEN	FONTE D'ALUMINIUM	8W-12W-16W-20W	2200K 2700K 3000K 4000K	3340Lm (4000K)	1500Lm (4000K)	0-100°	220,00



NOIR MAT



BLANC MAT



ACIER CORTEN

RUBYX S



BRIKPRO 1



- Applique murale pour éclairage extérieur.
- Diffuseur en verre opalin.
- Eclairage direct.
- Convertisseur non dimmable intégré dans l'appareil.

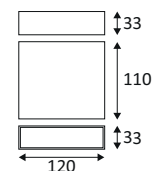

BRIKPRO 1	COULEUR	MATIÈRE	P	CCT	LED LUMEN	SYSTEM LUMEN	α	€
BP12/1D/3K/A	ANTHRACITE	FONTE D'ALUMINIUM	7W	3000K	870Lm	695Lm	80°	105,00
BP12/1D/3K/G	GRIS MAT	FONTE D'ALUMINIUM	7W	3000K	870Lm	695Lm	80°	105,00
BP12/1D/3K/W	BLANC MAT	FONTE D'ALUMINIUM	7W	3000K	870Lm	695Lm	80°	105,00
BP12/1D/3K/BR	ACIER CORTEN	FONTE D'ALUMINIUM	7W	3000K	870Lm	695Lm	80°	110,00



ANTHRACITE



GRIS MAT



BLANC MAT



ACIER CORTEN

BRIKPRO 1 A



- Applique murale pour éclairage extérieur.
- Diffuseur en verre sérigraphié noir.
- Faisceau asymétrique.
- Eclairage direct.
- Convertisseur non dimmable intégré dans l'appareil.

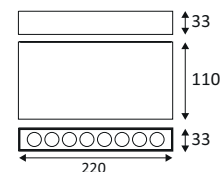
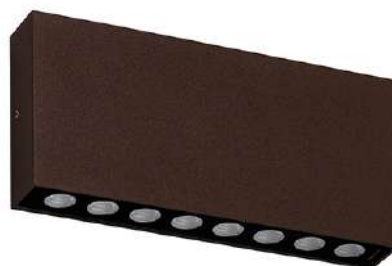

BRIKPRO 1 A	COULEUR	MATIÈRE	P	CCT	LED LUMEN	SYSTEM LUMEN	α	€
BP22/1C/3K/A	ANTHRACITE	FONTE D'ALUMINIUM	14W	3000K	1300Lm	940Lm	40°	230,00
BP22/1C/3K/G	GRIS MAT	FONTE D'ALUMINIUM	14W	3000K	1300Lm	940Lm	40°	230,00
BP22/1C/3K/W	BLANC MAT	FONTE D'ALUMINIUM	14W	3000K	1300Lm	940Lm	40°	230,00
BP22/1C/3K/BR	ACIER CORTEN	FONTE D'ALUMINIUM	14W	3000K	1300Lm	940Lm	40°	235,00



ANTHRACITE



GRIS MAT



BLANC MAT



ACIER CORTEN



BRIKPRO 1

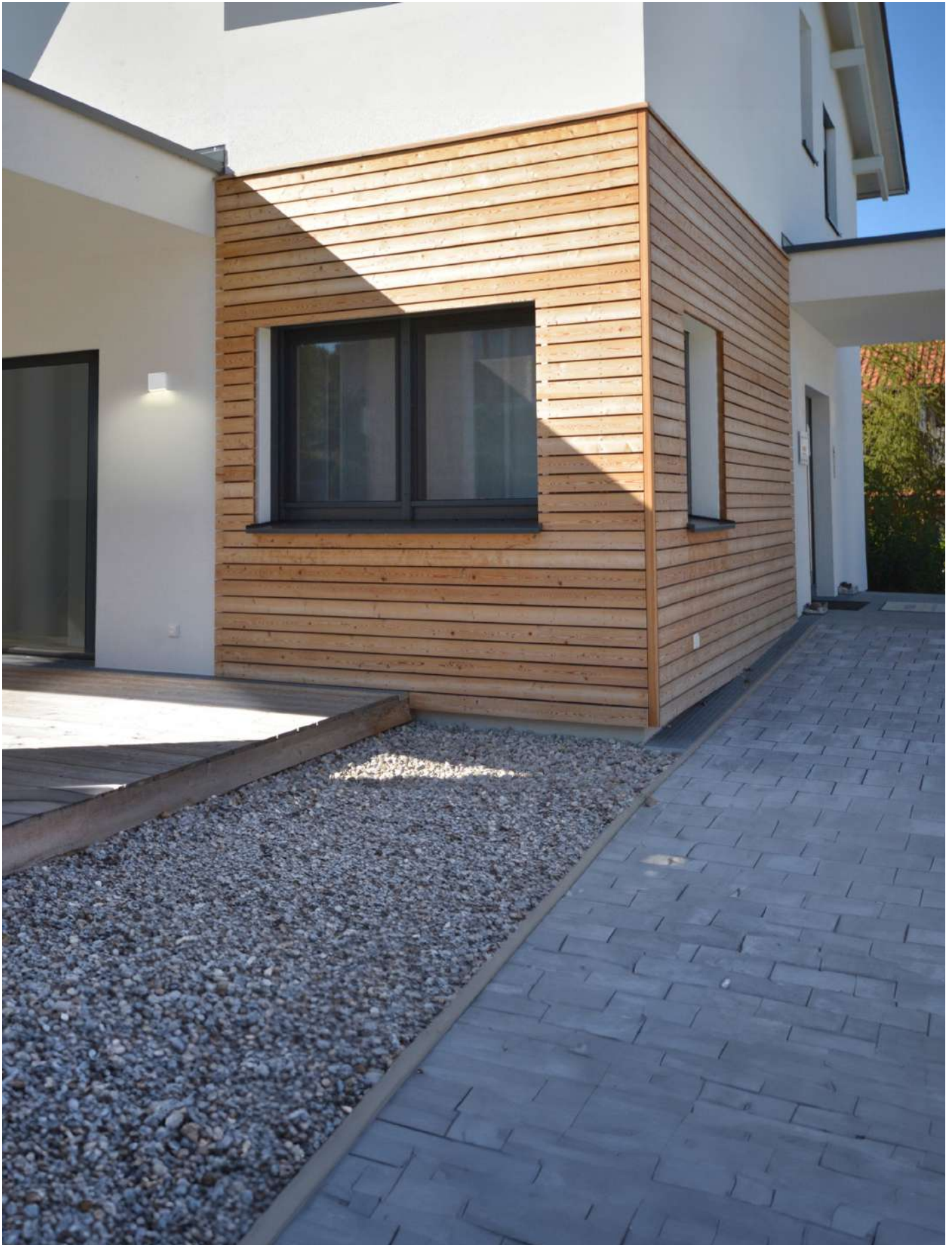

BRIKPRO 2



- Applique murale pour éclairage extérieur.
- Diffuseurs en verre opalin.
- Eclairage direct/indirect.
- Convertisseur non dimmable intégré dans l'appareil.

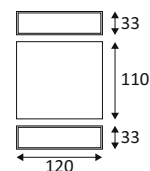

BRIKPRO 2	COULEUR	MATIÈRE	P	CCT	LED LUMEN	SYSTEM LUMEN	α	€
BP12/2D/3K/A	ANTHRACITE	FONTE D'ALUMINIUM	14W	3000K	2X870Lm	1390Lm	80°	120,00
BP12/2D/3K/G	GRIS MAT	FONTE D'ALUMINIUM	14W	3000K	2X870Lm	1390Lm	80°	120,00
BP12/2D/3K/W	BLANC MAT	FONTE D'ALUMINIUM	14W	3000K	2X870Lm	1390Lm	80°	120,00
BP12/2D/3K/BR	ACIER CORTEN	FONTE D'ALUMINIUM	14W	3000K	2X870Lm	1390Lm	80°	125,00



ANTHRACITE



GRIS MAT



BLANC MAT



ACIER CORTEN

BRIKPRO 2 A



- Applique murale pour éclairage extérieur.
- Diffuseurs en verre sérigraphié noir.
- Faisceaux asymétriques.
- Eclairage direct/indirect.
- Convertisseur non dimmable intégré dans l'appareil.

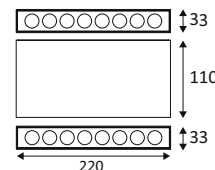

BRIKPRO 2 A	COULEUR	MATIÈRE	P	CCT	LED LUMEN	SYSTEM LUMEN	α	€
BP22/2C/3K/A	ANTHRACITE	FONTE D'ALUMINIUM	28W	3000K	2X1300Lm	1880Lm	40°	260,00
BP22/2C/3K/G	GRIS MAT	FONTE D'ALUMINIUM	28W	3000K	2X1300Lm	1880Lm	40°	260,00
BP22/2C/3K/W	BLANC MAT	FONTE D'ALUMINIUM	28W	3000K	2X1300Lm	1880Lm	40°	260,00
BP22/2C/3K/BR	ACIER CORTEN	FONTE D'ALUMINIUM	28W	3000K	2X1300Lm	1880Lm	40°	265,00



ANTHRACITE



GRIS MAT



BLANC MAT



ACIER CORTEN



APPLIQUES

POLO

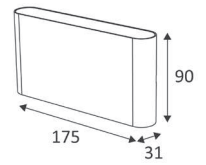

- Applique murale pour éclairage extérieur.
- 2700K, 3000K ou 4000K au choix via un interrupteur dans le luminaire.
- Eclairage «up&down».
- Avec entrée et sortie de câble.
- Convertisseur non dimmable intégré dans l'appareil.

POLO	COULEUR	MATIÈRE	P	CCT	LED LUMEN	SYSTEM LUMEN	€
OU49505	■ NOIR MAT	ALUMINIUM	10W	2700K 3000K 4000K	2X600Lm (4000K)	1040Lm (4000K)	103,00
OU49530	□ BLANC MAT	ALUMINIUM	10W	2700K 3000K 4000K	2X600Lm (4000K)	1110Lm (4000K)	103,00



NOIR MAT



BLANC MAT

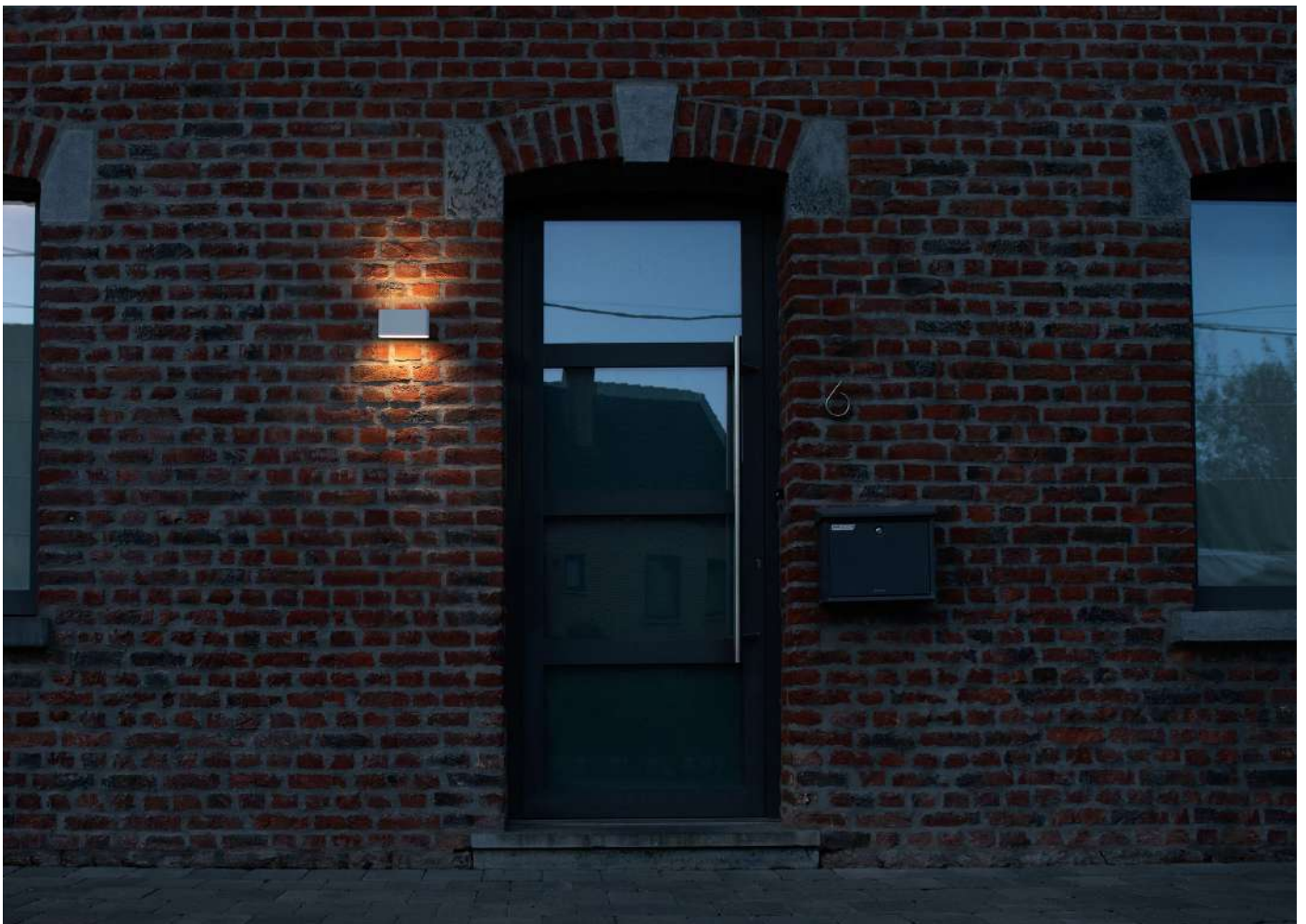

PLAFONNIERS

ROMY R GU10



- Plafonnier rond pour éclairage extérieur.
- Diffuseur en verre.
- Avec entrée et sortie de câble.

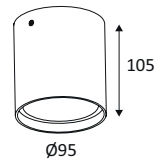

ROMY R GU10	COULEUR	MATIÈRE	DOUILLE	LAMPE	WATT MAX	€
OU50405	■ NOIR MAT	ALUMINIUM	GU10	PAR16 LED	7W	73,00
OU50430	■ BLANC MAT	ALUMINIUM	GU10	PAR16 LED	7W	73,00



NOIR MAT



BLANC MAT

ROMY S GU10



- Plafonnier carré pour éclairage extérieur.
- Diffuseur en verre.
- Avec entrée et sortie de câble.

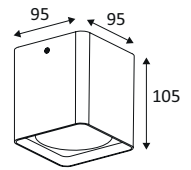

ROMY S GU10	COULEUR	MATIÈRE	DOUILLE	LAMPE	WATT MAX	€
OU50505	■ NOIR MAT	ALUMINIUM	GU10	PAR16 LED	7W	73,00
OU50530	■ BLANC MAT	ALUMINIUM	GU10	PAR16 LED	7W	73,00



NOIR MAT



BLANC MAT



PLAFONNIERS

ROMY R GU10



LEWIS



- Plafonnier pour éclairage extérieur.
- Diffuseur en verre.
- Ne nécessite pas de convertisseur.
- Non dimmable.

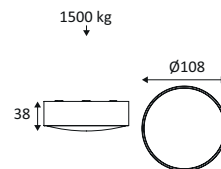

LEWIS	COULEUR	MATIÈRE	P	CCT	LED LUMEN	SYSTEM LUMEN	α	€
OU424WW24	■ ANTHRACITE	FONTE D'ALUMINIUM	6W	3000K	470Lm	320Lm	95°	120,00

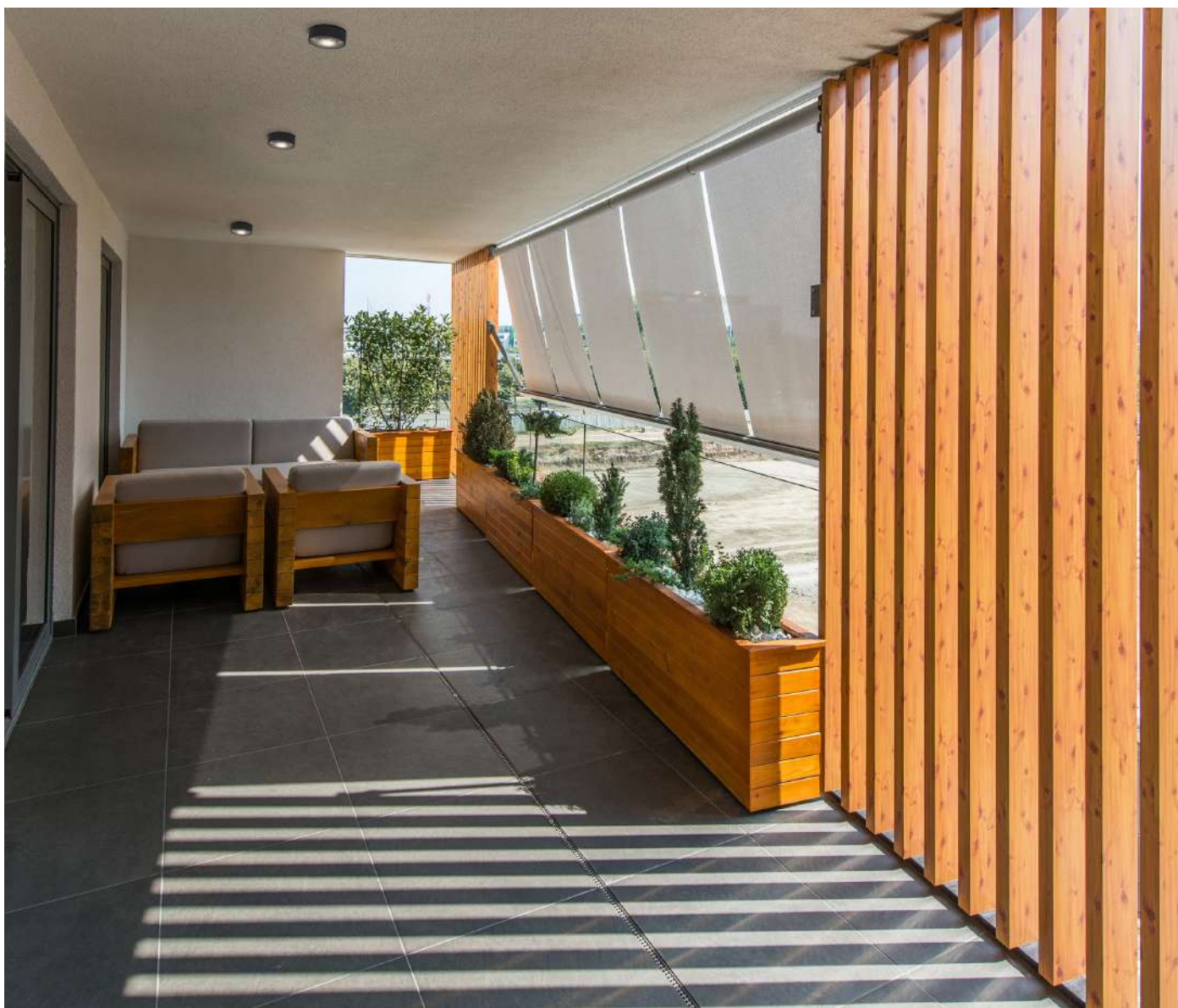

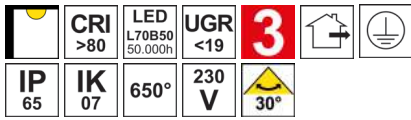
**UNIS R**

- Plafonnier rond pour éclairage extérieur.
- Réflecteur basse luminance.
- Avec entrée et sortie de câble.
- Convertisseur non dimmable intégré dans l'appareil.

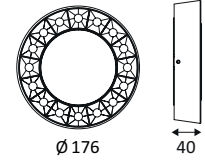

UNIS R	COULEUR	MATIÈRE	P	CCT	LED LUMEN	SYSTEM LUMEN	α	€
OU459WW24	■ ANTHRACITE	ALUMINIUM	14W	3000K	1250Lm	1090Lm	30°	182,00

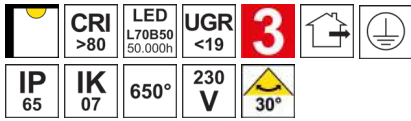
UNIS S

- Plafonnier carré pour éclairage extérieur.
- Réflecteur basse luminance.
- Avec entrée et sortie de câble.
- Convertisseur non dimmable intégré dans l'appareil.

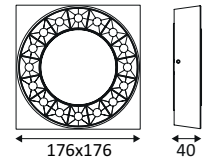

UNIS S	COULEUR	MATIÈRE	P	CCT	L(MM)	LED LUMEN	SYSTEM LUMEN	α	€
OU460WW24	■ ANTHRACITE	ALUMINIUM	14W	3000K	176	1250Lm	1090Lm	30°	182,00

LUZ 1

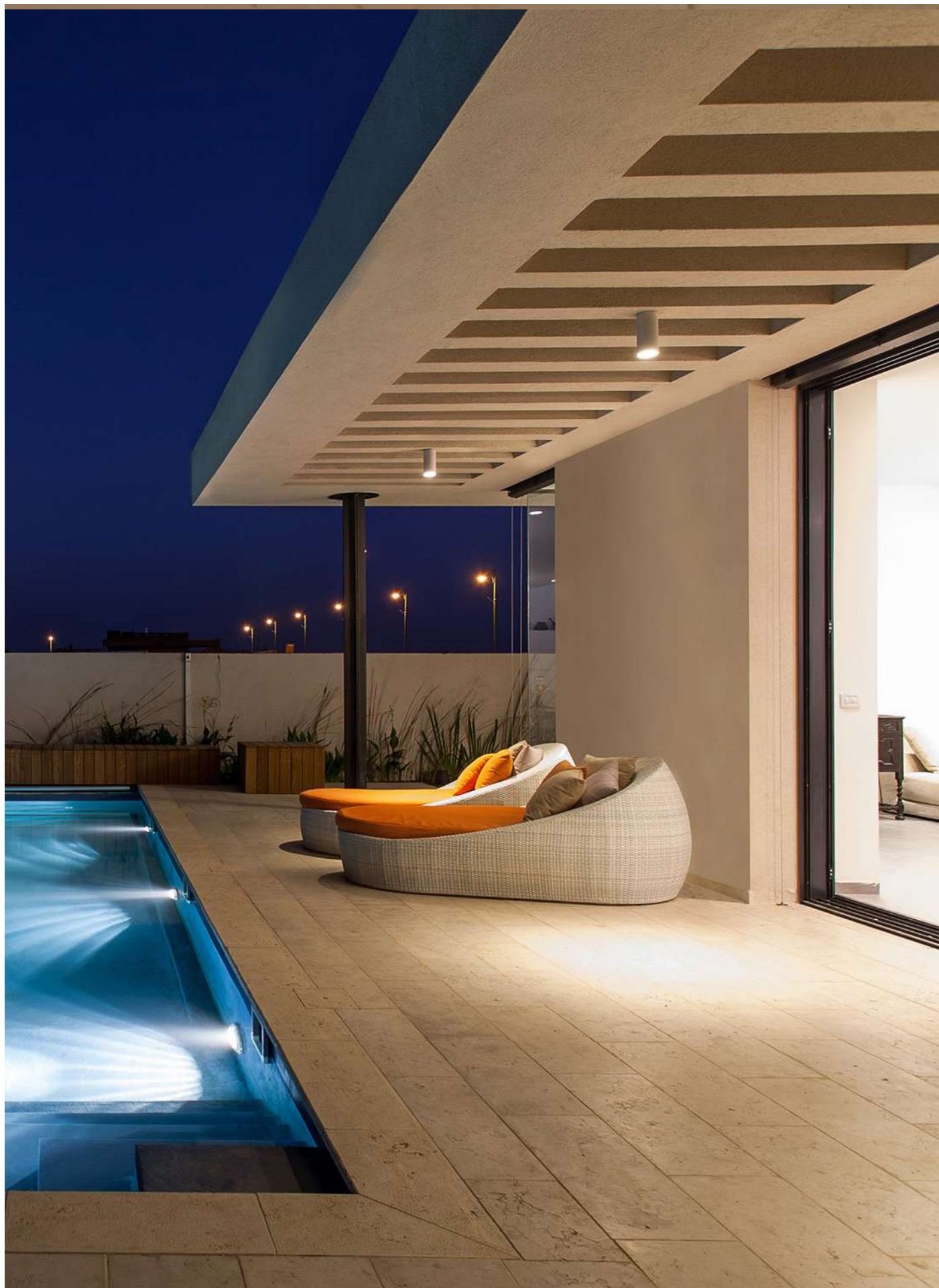



PLAFONNIERS

LUZ 1

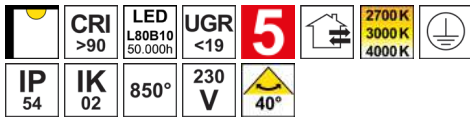

- Plafonnier pour éclairage extérieur.
- 2700K, 3000K ou 4000K au choix via un interrupteur dans le luminaire.
- Diffuseur en verre.
- Convertisseur non dimmable intégré dans l'appareil.

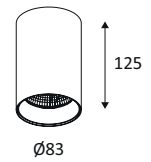

LUZ 1	COULEUR	MATIÈRE	P	CCT	LED LUMEN	SYSTEM LUMEN	α	€
OU48905	■ NOIR MAT	ALUMINIUM	15W	2700K 3000K 4000K	1590Lm (4000K)	945Lm (4000K)	40°	105,00
OU48930	□ BLANC MAT	ALUMINIUM	15W	2700K 3000K 4000K	1590Lm (4000K)	1035Lm (4000K)	40°	105,00



NOIR MAT



BLANC MAT

LUZ 2

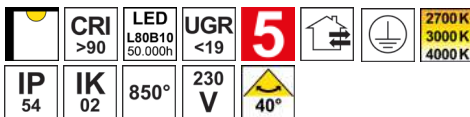

- Plafonnier pour éclairage extérieur.
- 2700K, 3000K ou 4000K au choix via un interrupteur dans le luminaire.
- Diffuseur en verre.
- Convertisseur non dimmable intégré dans l'appareil.

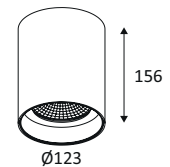

LUZ 2	COULEUR	MATIÈRE	P	CCT	LED LUMEN	SYSTEM LUMEN	α	€
OU49005	■ NOIR MAT	ALUMINIUM	20W	2700K 3000K 4000K	1930Lm (4000K)	1475Lm (4000K)	40°	136,00
OU49030	□ BLANC MAT	ALUMINIUM	20W	2700K 3000K 4000K	1930Lm (4000K)	1485Lm (4000K)	40°	136,00



NOIR MAT



BLANC MAT

FARO 1



- Plafonnier pour éclairage intérieur et extérieur.
- Diffuseur en verre trempé clair.
- Avec entrée et sortie de câble.
- Convertisseur dimmable intégré dans l'appareil.
- Compatible avec variateur début et fin de phase.

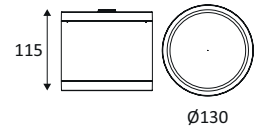

FARO 1	COULEUR	MATIÈRE	P	CCT	LED LUMEN	SYSTEM LUMEN	α	€
OU447WW05	NOIR MAT	ALUMINIUM	24W	3000K	3150Lm	2595Lm	36°	187,00
OU447WW30	BLANC MAT	ALUMINIUM	24W	3000K	3150Lm	2605Lm	36°	187,00
OU447NW05	NOIR MAT	ALUMINIUM	24W	4000K	3200Lm	2770Lm	36°	187,00
OU447NW30	BLANC MAT	ALUMINIUM	24W	4000K	3200Lm	2750Lm	36°	187,00



NOIR MAT



BLANC MAT

FARO 2



- Plafonnier pour éclairage intérieur et extérieur.
- Diffuseur en verre trempé clair.
- Avec entrée et sortie de câble.
- Convertisseur dimmable intégré dans l'appareil.
- Compatible avec variateur début et fin de phase.

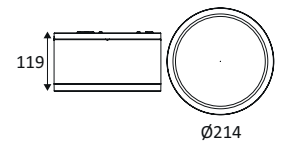

FARO 2	COULEUR	MATIÈRE	P	CCT	LED LUMEN	SYSTEM LUMEN	α	€
OU448WW05	NOIR MAT	ALUMINIUM	34W	3000K	4350Lm	3760Lm	60°	297,00
OU448WW30	BLANC MAT	ALUMINIUM	34W	3000K	4350Lm	3865Lm	60°	297,00
OU448NW05	NOIR MAT	ALUMINIUM	34W	4000K	4360Lm	3940Lm	60°	297,00
OU448NW30	BLANC MAT	ALUMINIUM	34W	4000K	4360Lm	3785Lm	60°	297,00



NOIR MAT



BLANC MAT



FARO 1



ASPI 1 SENSOR PLUS



- Applique murale ou plafonnier.
- 3000K ou 4000K au choix via un interrupteur dans le luminaire.
- Avec détecteur HF 360° (plafond) 150° (mur), zone de détection réglable max. 12m de diamètre.
- Diffuseur en polycarbonate opalin.
- Convertisseur non dimmable intégré dans l'appareil.



ASPI 1 SENSOR PLUS	COULEUR	MATIÈRE	P	CCT	LED LUMEN	SYSTEM LUMEN	α	€
OU440NW24	■ ANTHRACITE	FONTE D'ALUMINIUM	30W	3000K 4000K	3000Lm (4000K)	2080Lm (4000K)	110°	200,00
OU440NW30	■ BLANC MAT	FONTE D'ALUMINIUM	30W	3000K 4000K	3000Lm (4000K)	2080Lm (4000K)	110°	200,00



ANTHRACITE



BLANC MAT

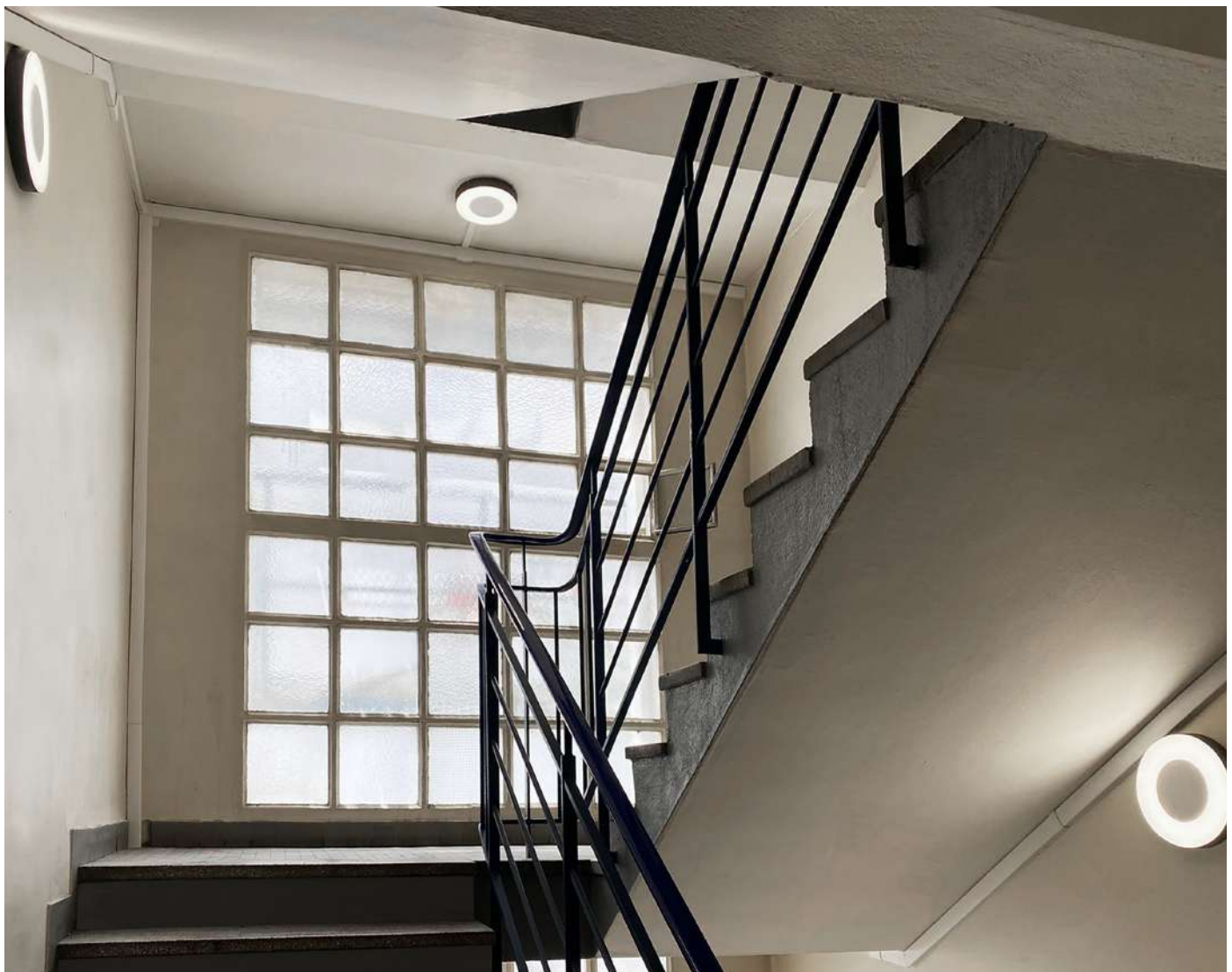

**ASPI 2 SENSOR PLUS**

- Applique murale ou plafonnier.
- 3000K ou 4000K au choix via un interrupteur dans le luminaire.
- Avec détecteur HF 360° (plafond) 150° (mur), zone de détection réglable max. 12m de diamètre.
- Diffuseur en polycarbonate opalin.
- Convertisseur non dimmable intégré dans l'appareil.



ASPI 2 SENSOR PLUS	COULEUR	MATIÈRE	P	CCT	LED LUMEN	SYSTEM LUMEN	α	€
OU441NW24	■ ANTHRACITE	FONTE D'ALUMINIUM	30W	3000K 4000K	3000Lm (4000K)	2080Lm (4000K)	110°	200,00
OU441NW30	■ BLANC MAT	FONTE D'ALUMINIUM	30W	3000K 4000K	3000Lm (4000K)	2080Lm (4000K)	110°	200,00



ANTHRACITE



BLANC MAT

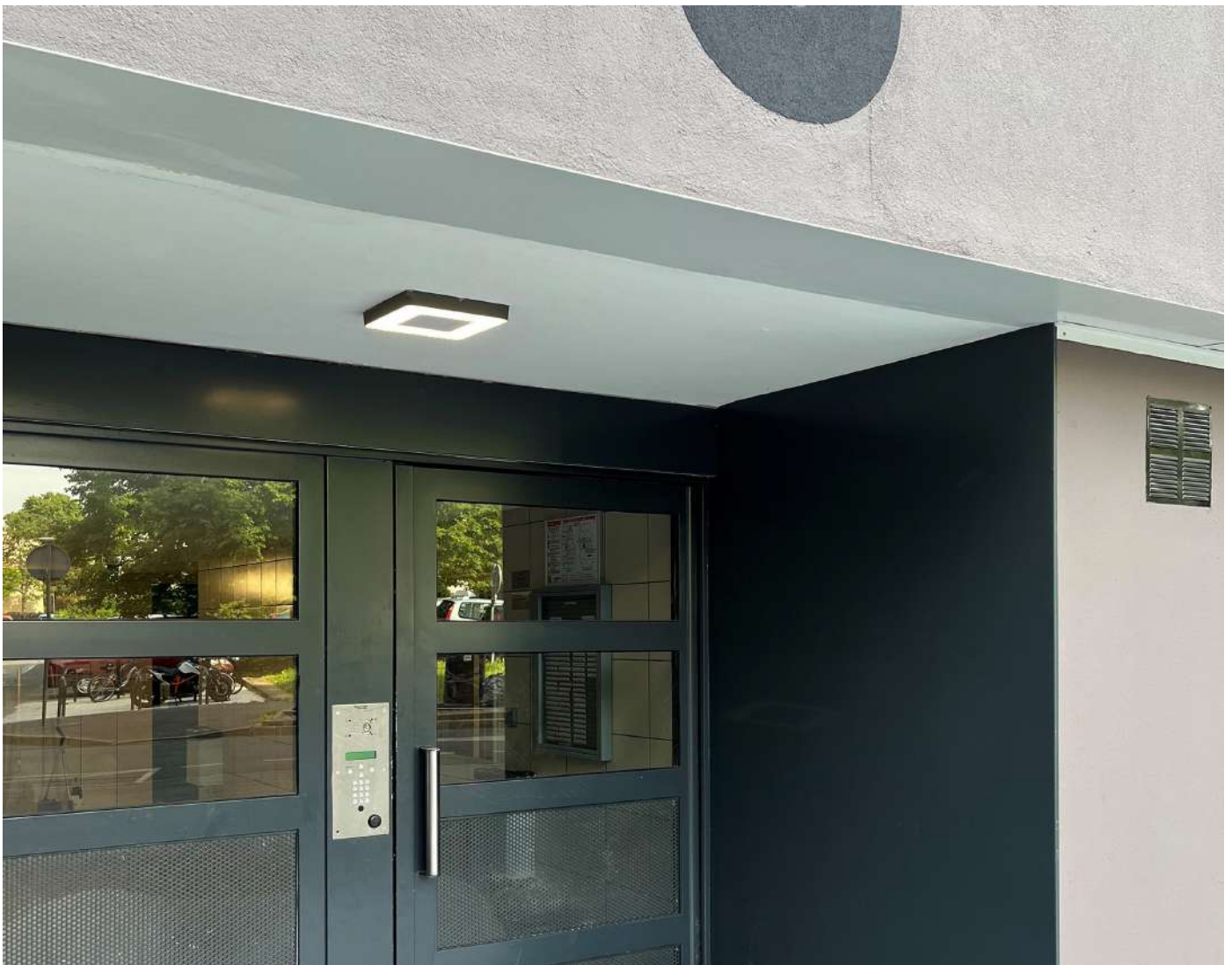

PROJECTEURS

Guide comparatif des Projecteurs

Quel luminaire correspond à votre projet ?

Utilisez les diagrammes ci-dessous pour choisir le luminaire adapté. La hauteur dont vous disposez et le niveau d'éclairage souhaité vous permettent de déterminer la puissance et la largeur de faisceau du luminaire à sélectionner. Référez-vous aux hauteurs indiquées dans les tableaux ci-dessous : chacune précise le diamètre d'éclairage obtenu et vous renseigne l'entraxe optimal entre les luminaires.

INDY 1 - (50 Lux)

Une seule référence offre trois niveaux de puissance.

FL100WW05

3000 K  **65 W**

FL100WW05

80 W

FL100WW05

125 W

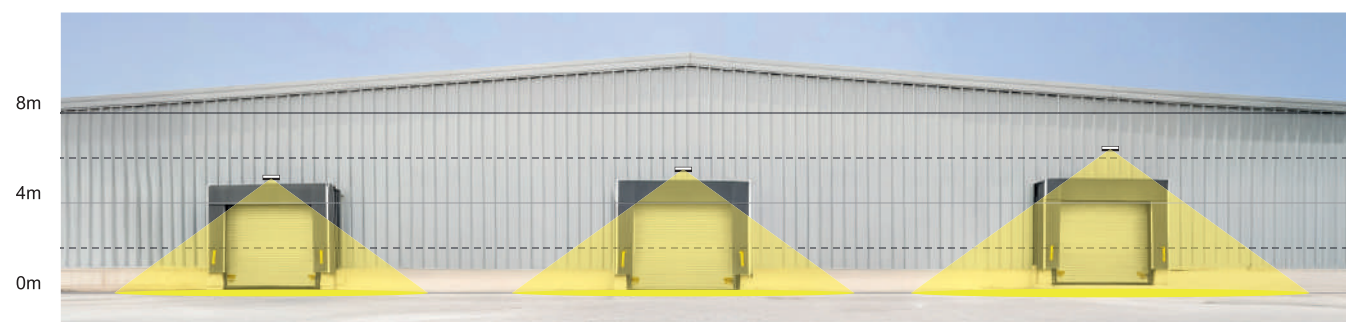

Ø 14m @ 5,1m		Ø 15,3m @ 5,6m		Ø 17,8m @ 6,5m	
h (m)	LUX	Ø (m)	h (m)	LUX	Ø (m)
2	325	5,5	2	385	5,5
4	80	11	4	95	11
6	36	16,5	6	43	16,5
8	20	22	8	24	22
10	13	27,5	10	15	27,5

FL100NW05

4000 K  **65 W**

FL100NW05

80 W

FL100NW05

125 W

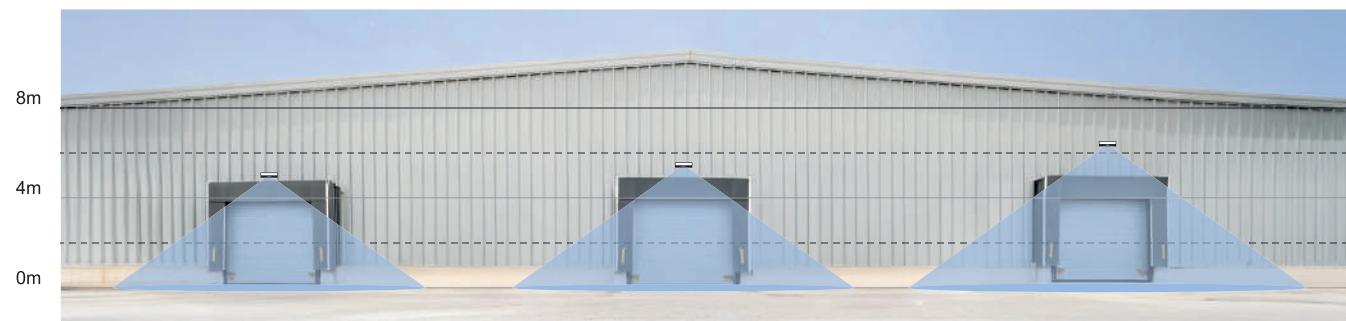

Ø 14,1m @ 4,9m		Ø 15,3m @ 5,3m		Ø 18m @ 6,3m	
h (m)	LUX	Ø (m)	h (m)	LUX	Ø (m)
2	296	5,8	2	350	5,8
4	74	11,5	4	88	11,5
6	33	17,5	6	39	17,5
8	18	23	8	22	23
10	12	29	10	14	29



INDY 2 - (50 Lux)

Une seule référence offre trois niveaux de puissance.

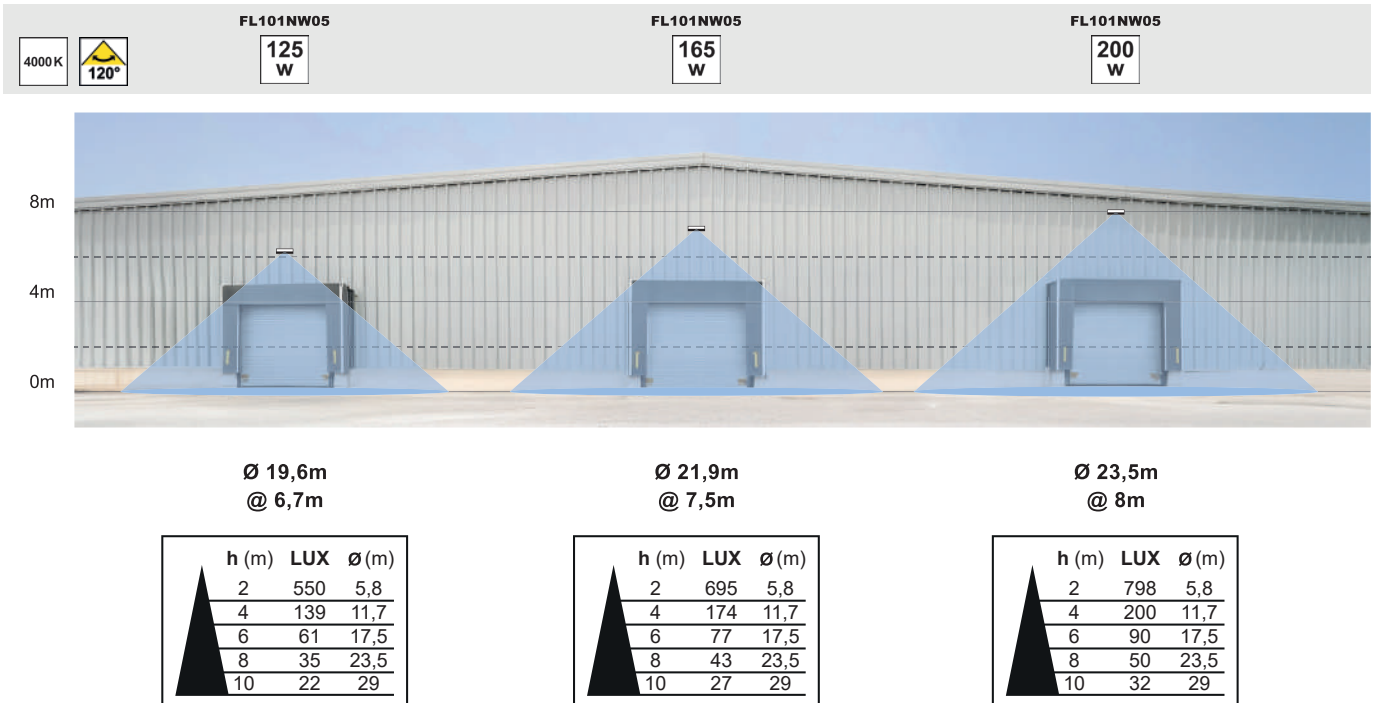
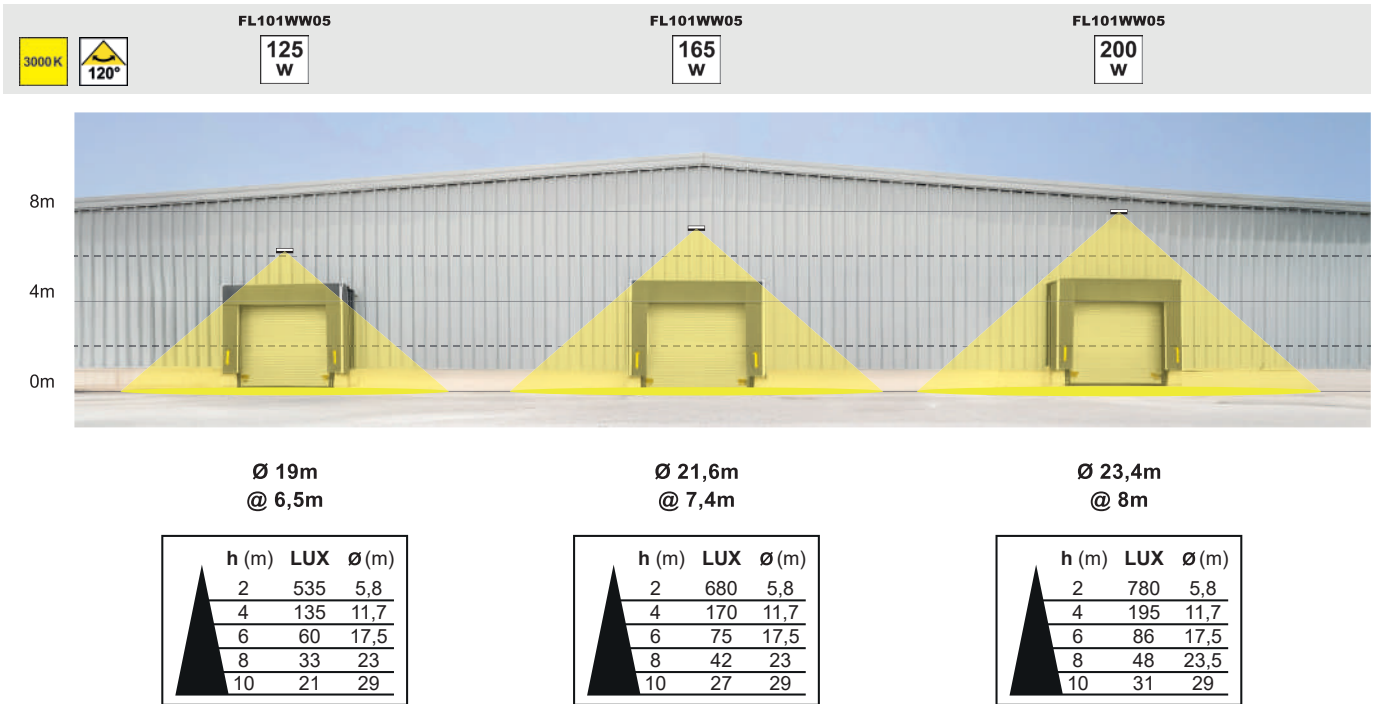

RAYPRO 14

Faisceau extensif pour les faibles hauteurs.



**PRO14/F/3K/-
50Lx**

**PRO14/F/3K/-
20Lx**



**Ø 5,7m
@ 2,2m**

**Ø 8,6m
@ 3,3m**

h (m)	LUX	Ø(m)
1	189	2,6
2	47	5,3
3	21	7,9
4	12	10,5

h (m)	LUX	Ø(m)
1	189	2,6
2	47	5,3
3	21	7,9
4	12	10,5

RAYPRO 32 & RAYPRO 50 (50 Lux)

Faisceau intensif pour les grandes hauteurs.



PRO32/M/3K/-

**32
W**

PRO50/M/3K/-

**50
W**



**Ø 5,6m
@ 9,1m**

**Ø 8,6m
@ 12m**



h (m)	LUX	Ø(m)
2	993	1,25
4	248	2,5
6	110	3,7
8	62	5
10	40	6,2

h (m)	LUX	Ø(m)
4	493	2,5
8	123	5
12	55	7,5
16	31	10



RAYPRO 32A & RAYPRO 50A (50 Lux)

Faisceau asymétrique.





PRO32/AS/3K/-

**32
W**

PRO50/AS/3K/-

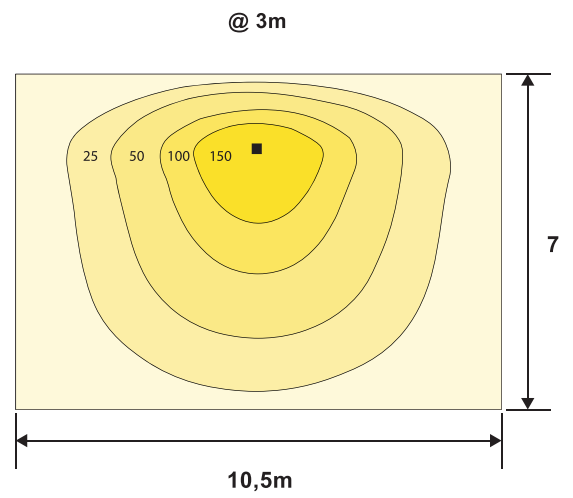
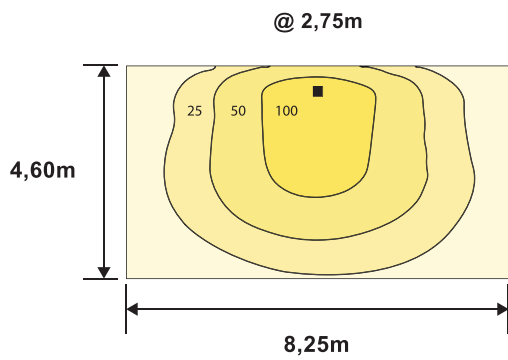
**50
W**



h (m)	LUX	Ø (m)
2	63	5 x 2,8
4	16	10 x 5,6
6	7	15 x 8,4
8	4	20 x 11,2
10	3	25 x 14

h (m)	LUX	Ø (m)
2	94	5,3 x 3,1
4	24	10,6 x 6,2
6	10	16 x 9,4
8	6	21,3 x 12,5
10	4	26,6 x 15,6

CURTIS PLUS

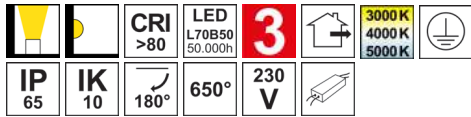

- Projecteur pour éclairage extérieur.
- 3000K, 4000K ou 5000K au choix via un interrupteur à l'arrière du luminaire.
- Diffuseur en polycarbonate.
- Livré avec 0.50m de câble.
- Convertisseur non dimmable intégré dans l'appareil.



CURTIS PLUS	COULEUR	MATIÈRE	P	CCT	L(MM)	LED LUMEN	SYSTEM LUMEN	α	€
OU47024	■ ANTHRACITE	FONTE D'ALUMINIUM	15W	3000K 4000K 5000K	147	1700Lm (4000K)	1340Lm (4000K)	120°	34,00
OU47124	■ ANTHRACITE	FONTE D'ALUMINIUM	30W	3000K 4000K 5000K	178	3500Lm (4000K)	2910Lm (4000K)	120°	55,00
OU47224	■ ANTHRACITE	FONTE D'ALUMINIUM	50W	3000K 4000K 5000K	208	5850Lm (4000K)	4225Lm (4000K)	120°	74,00
OU47324	■ ANTHRACITE	FONTE D'ALUMINIUM	70W	3000K 4000K 5000K	260	8000Lm (4000K)	6435Lm (4000K)	120°	102,00

ACCESSOIRES	COULEUR	MATIÈRE	DESCRIPTION	€
OU17505	NOIR	FONTE D'ALUMINIUM	CURTIS PLUS 15W PIQUET OPTIONNEL	13,00
OU48405			CONNECTEUR 2PIN IP68	11,00
OU48505			CONNECTEUR 3PIN IP68	30,00

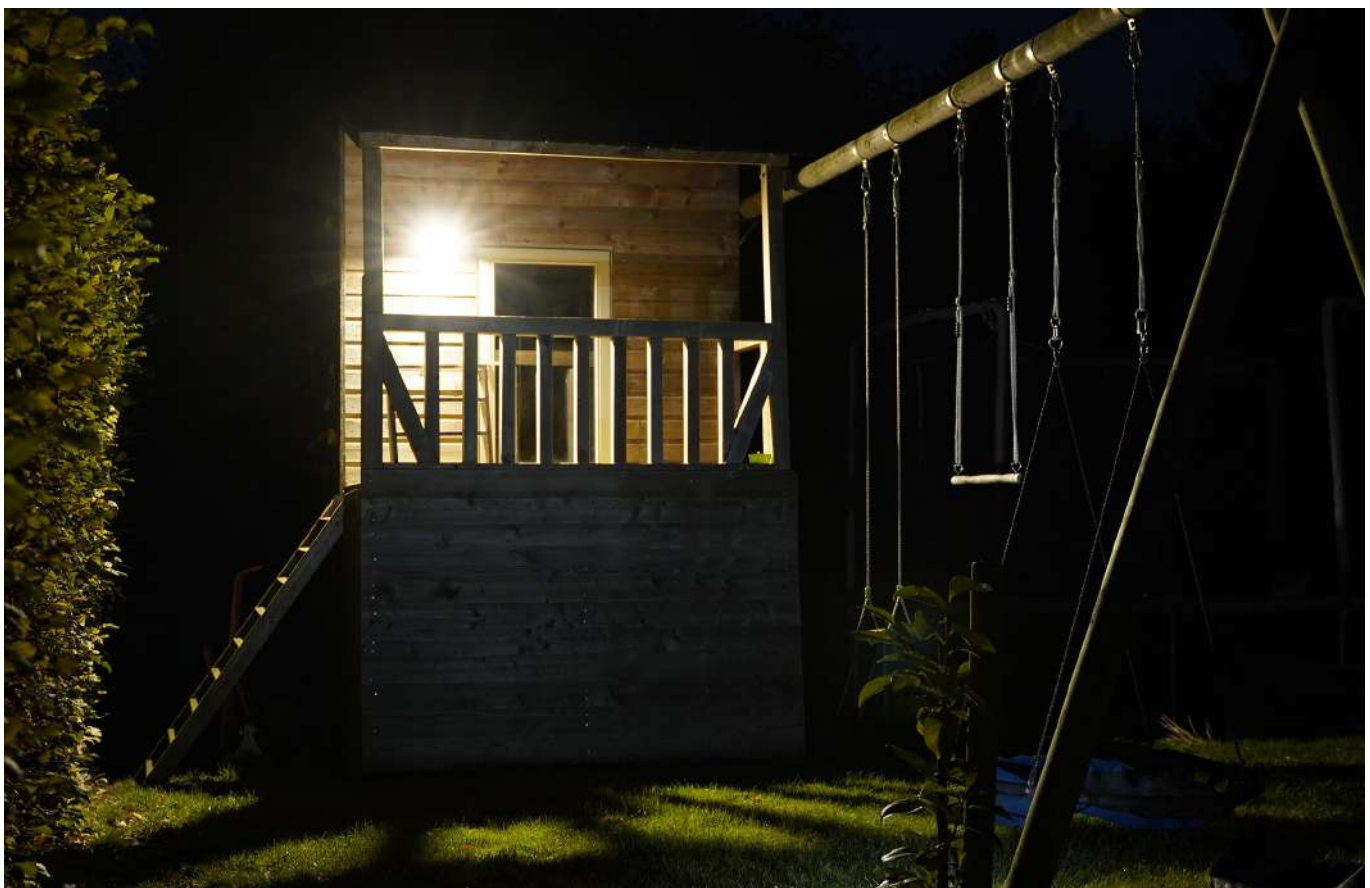



CURTIS SENSOR PLUS

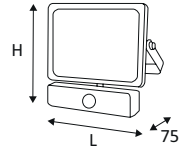

- Projecteur pour éclairage extérieur.
- 3000K, 4000K ou 5000K au choix via un interrupteur à l'arrière du luminaire.
- Diffuseur en polycarbonate.
- Livré avec 0.50m de câble.
- Avec détecteur orientable IR 120°, zone de détection réglable max. 8m.
- Convertisseur non dimmable intégré dans l'appareil.

CURTIS SENSOR PLUS	COULEUR	MATIÈRE	P	CCT	L(MM)	LED LUMEN	SYSTEM LUMEN	α	€
OU47424	■ ANTHRACITE	FONTE D'ALUMINIUM	15W	3000K 4000K 5000K	147	1700Lm (4000K)	1340Lm (4000K)	120°	57,00
OU47524	■ ANTHRACITE	FONTE D'ALUMINIUM	30W	3000K 4000K 5000K	178	3500Lm (4000K)	2910Lm (4000K)	120°	74,00
OU47624	■ ANTHRACITE	FONTE D'ALUMINIUM	50W	3000K 4000K 5000K	208	5850Lm (4000K)	4225Lm (4000K)	120°	89,00

ACCESSOIRES	DESCRIPTION	€
OU48405	CONNECTEUR 2PIN IP68	11,00
OU48505	CONNECTEUR 3PIN IP68	30,00



INDY 1



- Projecteur pour éclairage extérieur.
- Multi-puissance : 65, 80 ou 125W au choix via un interrupteur à l'arrière du luminaire.
- Diffuseur en verre trempé dépoli.
- Livré avec 1.00m de câble.
- Convertisseur non dimmable intégré dans l'appareil.

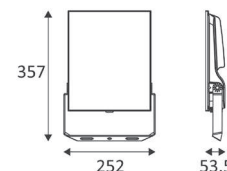

INDY 1	COULEUR	MATIÈRE	P	CCT	LED LUMEN	SYSTEM LUMEN	α	€
FL100WW05	NOIR	FONTE D'ALUMINIUM	65 - 80 - 125W	3000K	12000Lm (65W) 14500Lm (80W) 19750Lm (125W)	10075Lm 11920Lm 16450Lm	120°	170,00
FL100NW05	NOIR	FONTE D'ALUMINIUM	65 - 80 - 125W	4000K	12500Lm (65W) 14750Lm (80W) 20500Lm (125W)	10310Lm 12230Lm 17145Lm	120°	170,00

ACCESSOIRES	DESCRIPTION	€
OU48405	CONNECTEUR 2PIN IP68	11,00
OU48505	CONNECTEUR 3PIN IP68	30,00

INDY 1 A



- Projecteur pour éclairage extérieur.
- Multi-puissance : 65, 80 ou 125W au choix via un interrupteur à l'arrière du luminaire.
- Diffuseur en verre trempé clair.
- Faisceau asymétrique.
- Livré avec 1.00m de câble.
- Convertisseur non dimmable intégré dans l'appareil.

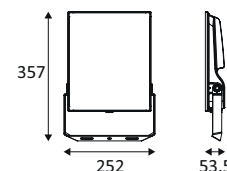

INDY 1 A	COULEUR	MATIÈRE	P	CCT	LED LUMEN	SYSTEM LU-MEN	€
FL102WW05	NOIR	FONTE D'ALUMINIUM	65 - 80 - 125W	3000K	11500Lm (65W) 13750Lm (80W) 18750Lm (125W)	9625Lm 11365Lm 15525Lm	180,00
FL102NW05	NOIR	FONTE D'ALUMINIUM	65 - 80 - 125W	4000K	12500Lm (65W) 14500Lm (80W) 19500Lm (125W)	10370Lm 12025Lm 16275Lm	180,00

ACCESSOIRES	DESCRIPTION	€
OU48405	CONNECTEUR 2PIN IP68	11,00
OU48505	CONNECTEUR 3PIN IP68	30,00



INDY 1 A



INDY 2





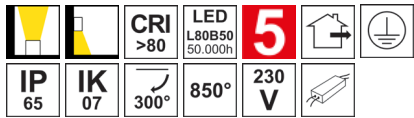

INDY 2

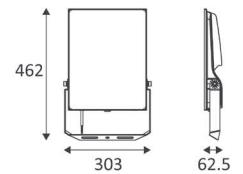

- Projecteur pour éclairage extérieur.
- Multi-puissance : 125, 165 ou 200W au choix via un interrupteur à l'arrière du luminaire.
- Diffuseur en verre trempé dépoli.
- Livré avec 1.00m de câble.
- Convertisseur non dimmable intégré dans l'appareil.



INDY 2	COULEUR	MATIÈRE	P	CCT	LED LUMEN	SYSTEM LUMEN	α	€
FL101WW05	■ NOIR	FONTE D'ALUMINIUM	125 - 165 - 200W	3000K	22500Lm (125W) 28500Lm (165W) 33000Lm (200W)	18785Lm 23780Lm 27385Lm	120°	226,00
FL101NW05	■ NOIR	FONTE D'ALUMINIUM	125 - 165 - 200W	4000K	23500Lm (125W) 29500Lm (165W) 33750Lm (200W)	19470Lm 24395Lm 28055Lm	120°	226,00

ACCESSOIRES	DESCRIPTION	€
OU48405	CONNECTEUR 2PIN IP68 	11,00
OU48505	CONNECTEUR 3PIN IP68 	30,00

INDY 2 A



- Projecteur pour éclairage extérieur.
- Multi-puissance : 125, 165 ou 200W au choix via un interrupteur à l'arrière du luminaire.
- Diffuseur en verre trempé clair.
- Faisceau asymétrique.
- Livré avec 1.00m de câble.
- Convertisseur non dimmable intégré dans l'appareil.

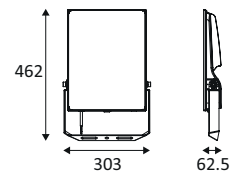

INDY 2 A	COULEUR	MATIÈRE	P	CCT	LED LUMEN	SYSTEM LU-MEN	€
FL103WW05	■ NOIR	FONTE D'ALUMINIUM	125 - 165 - 200W	3000K	20000Lm (125W) 25500Lm (165W) 31000Lm (200W)	16575Lm 21220Lm 25695Lm	236,00
FL103NW05	■ NOIR	FONTE D'ALUMINIUM	125 - 165 - 200W	4000K	22250Lm (125W) 27000Lm (165W) 31000Lm (200W)	18440Lm 22355Lm 25720Lm	236,00

ACCESSOIRES	DESCRIPTION	€
OU48405	CONNECTEUR 2PIN IP68 	11,00
OU48505	CONNECTEUR 3PIN IP68 	30,00

INDY K3 CSP



- Projecteur pour éclairage extérieur.
- CCT (3000K, 4000K ou 5000K) et puissance (IFLB1: 50, 80 ou 100W; IFLB2: 100, 150 ou 200W) au choix via un interrupteur au bas du luminaire.
- Livré avec 1,00m de câble et un presse-étoupe à connexion rapide.
- Convertisseur non dimmable intégré dans l'appareil.
- Système d'ouverture rapide du luminaire pour faciliter sa maintenance.

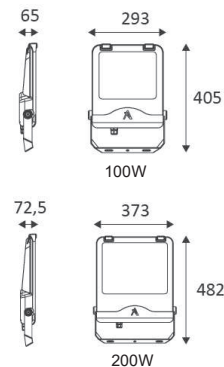

INDY K3 CSP	COULEUR	MATIÈRE	P	CCT	LED LUMEN	SYSTEM LUMEN	α	€
IFLB1NSCSP NEW	NOIR	ALUMINIUM	50-80-100W	3000K 4000K 5000K	18250Lm (4000K)	17150Lm (4000K)	110°	160,00
IFLB2NSCSP NEW	NOIR	ALUMINIUM	100-150-200W	3000K 4000K 5000K	36500Lm (4000K)	34300Lm (4000K)	110°	220,00

INDY K3 CSP A



- Projecteur pour éclairage extérieur.
- Faisceau asymétrique.
- CCT (3000K, 4000K ou 5000K) et puissance (IFLB1: 50, 80 ou 100W; IFLB2: 100, 150 ou 200W) au choix via un interrupteur au bas du luminaire.
- Livré avec 1,00m de câble et un presse-étoupe à connexion rapide.
- Convertisseur non dimmable intégré dans l'appareil.
- Système d'ouverture rapide du luminaire pour faciliter sa maintenance.

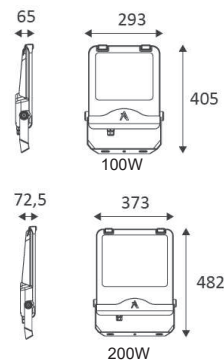

INDY K3 CSP A	COULEUR	MATIÈRE	P	CCT	LED LUMEN	SYSTEM LUMEN	α	€
IFLB1NACSP NEW	NOIR	ALUMINIUM	50-80-100W	3000K 4000K 5000K	18250Lm (4000K)	14725Lm (4000K)	100X55°	180,00
IFLB2NACSP NEW	NOIR	ALUMINIUM	100-150-200W	3000K 4000K 5000K	36500Lm (4000K)	29450Lm (4000K)	100X55°	240,00



RAYPRO 14

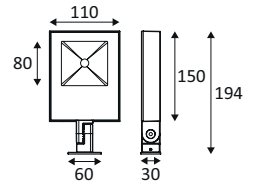
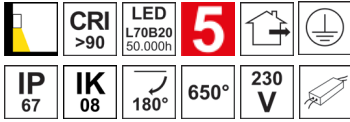

- Projecteur pour éclairage extérieur.
- Diffuseur en verre sérigraphié noir.
- Livré avec 1.50m de câble (HO5RN-F 3x0.75mm²).
- Convertisseur non dimmable intégré dans l'appareil.

RAYPRO 14	COULEUR	MATIÈRE	P	CCT	LED LUMEN	SYSTEM LUMEN	α	€
PRO14/F/3K/A	■ ANTHRACITE	FONTE D'ALUMINIUM	14W	3000K	1700Lm	1610Lm	110°	116
PRO14/F/3K/G	■ GRIS MAT	FONTE D'ALUMINIUM	14W	3000K	1700Lm	1610Lm	110°	116
PRO14/F/3K/W	■ BLANC MAT	FONTE D'ALUMINIUM	14W	3000K	1700Lm	1610Lm	110°	116



ANTHRACITE



GRIS MAT



BLANC MAT



RAYPRO 32

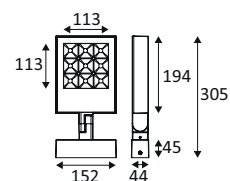
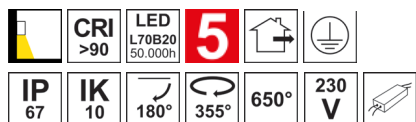

- Projecteur pour éclairage extérieur.
- Diffuseur en verre sérigraphié noir.
- Livré avec 1.50m de câble (HO5RN-F 3x0.75mm²).
- Convertisseur non dimmable intégré dans l'appareil.

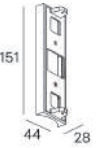

RAYPRO 32	COULEUR	MATIÈRE	P	CCT	LED LUMEN	SYSTEM LUMEN	α	€
PRO32/M/3K/A	■ ANTHRACITE	FONTE D'ALUMINIUM	32W	3000K	3200Lm	2435Lm	36°	249,00
PRO32/M/3K/G	■ GRIS MAT	FONTE D'ALUMINIUM	32W	3000K	3200Lm	2435Lm	36°	249,00
PRO32/M/3K/W	■ BLANC MAT	FONTE D'ALUMINIUM	32W	3000K	3200Lm	2435Lm	36°	249,00

ACCESSOIRES	COULEUR	MATIÈRE	DESCRIPTION	L(MM)	€
BASE/PRO/A	ANTHRACITE	ALUMINIUM	EQUERRE DE FIXATION POUR POTEAU DIAM. 60MM & 76MM		45,00
POLE/PRO/G	GRIS MAT	ALUMINIUM	TETE DE FIXATION POUR POTEAU DIAM. 60MM		80,00
BASE/PRO/W	BLANC MAT	ALUMINIUM	EQUERRE DE FIXATION POUR POTEAU DIAM. 60MM & 76MM		45,00
POLE/PRO/A	ANTHRACITE	ALUMINIUM	TETE DE FIXATION POUR POTEAU DIAM. 60MM		80,00
BASE/PRO/G	GRIS MAT	ALUMINIUM	EQUERRE DE FIXATION POUR POTEAU DIAM. 60MM & 76MM		45,00
POLE/PRO/W	BLANC MAT	ALUMINIUM	TETE DE FIXATION POUR POTEAU DIAM. 60MM		80,00



ANTHRACITE GRIS MAT BLANC MAT



RAYPRO 32 A

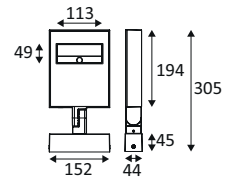
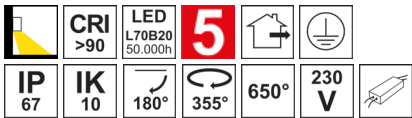

- Projecteur pour éclairage extérieur.
- Diffuseur en verre sérigraphié noir.
- Faisceau asymétrique.
- Livré avec 1.50m de câble (HO5RN-F 3x0.75mm²).
- Convertisseur non dimmable intégré dans l'appareil.

RAYPRO 32 A	COULEUR	MATIÈRE	P	CCT	LED LUMEN	SYSTEM LUMEN	€
PRO32/AS/3K/A	ANTHRACITE	FONTE D'ALUMINIUM	32W	3000K	3300Lm	2335Lm	230,00
PRO32/AS/3K/G	GRIS MAT	FONTE D'ALUMINIUM	32W	3000K	3300Lm	2335Lm	230,00
PRO32/AS/3K/W	BLANC MAT	FONTE D'ALUMINIUM	32W	3000K	3300Lm	2335Lm	230,00

ACCESSOIRES	COULEUR	MATIÈRE	DESCRIPTION	L(MM)	€
BASE/PRO/A	ANTHRACITE	ALUMINIUM	EQUERRE DE FIXATION POUR POTEAU DIAM. 60MM & 76MM		45,00
POLE/PRO/G	GRIS MAT	ALUMINIUM	TETE DE FIXATION POUR POTEAU DIAM. 60MM		80,00
BASE/PRO/W	BLANC MAT	ALUMINIUM	EQUERRE DE FIXATION POUR POTEAU DIAM. 60MM & 76MM		45,00
POLE/PRO/A	ANTHRACITE	ALUMINIUM	TETE DE FIXATION POUR POTEAU DIAM. 60MM		80,00
BASE/PRO/G	GRIS MAT	ALUMINIUM	EQUERRE DE FIXATION POUR POTEAU DIAM. 60MM & 76MM		45,00
POLE/PRO/W	BLANC MAT	ALUMINIUM	TETE DE FIXATION POUR POTEAU DIAM. 60MM		80,00



ANTHRACITE



GRIS MAT



BLANC MAT

RAYPRO 50



- Projecteur pour éclairage extérieur.
- Diffuseur en verre sérigraphié noir.
- Livré avec 1.50m de câble (HO5RN-F 3x0.75mm²).
- Convertisseur non dimmable intégré dans l'appareil.

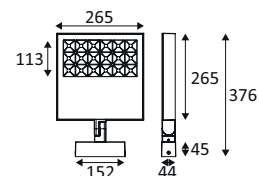

RAYPRO 50	COULEUR	MATIÈRE	P	CCT	LED LUMEN	SYSTEM LUMEN	α	€
PRO50/M/3K/A	■ ANTHRACITE	FONTE D'ALUMINIUM	50W	3000K	5400Lm	4120Lm	36°	317,00
PRO50/M/3K/G	■ GRIS MAT	FONTE D'ALUMINIUM	50W	3000K	5400Lm	4120Lm	36°	317,00
PRO50/M/3K/W	■ BLANC MAT	FONTE D'ALUMINIUM	50W	3000K	5400Lm	4120Lm	36°	317,00

ACCESSOIRES	COULEUR	MATIÈRE	DESCRIPTION	L(MM)	€
BASE/PRO/A	ANTHRACITE	ALUMINIUM	EQUERRE DE FIXATION POUR POTEAU DIAM. 60MM & 76MM		45,00
POLE/PRO/G	GRIS MAT	ALUMINIUM	TETE DE FIXATION POUR POTEAU DIAM. 60MM		80,00
BASE/PRO/W	BLANC MAT	ALUMINIUM	EQUERRE DE FIXATION POUR POTEAU DIAM. 60MM & 76MM		45,00
POLE/PRO/A	ANTHRACITE	ALUMINIUM	TETE DE FIXATION POUR POTEAU DIAM. 60MM		80,00
BASE/PRO/G	GRIS MAT	ALUMINIUM	EQUERRE DE FIXATION POUR POTEAU DIAM. 60MM & 76MM		45,00
POLE/PRO/W	BLANC MAT	ALUMINIUM	TETE DE FIXATION POUR POTEAU DIAM. 60MM		80,00



ANTHRACITE

GRIS MAT

BLANC MAT



RAYPRO 50 A

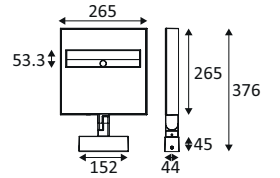
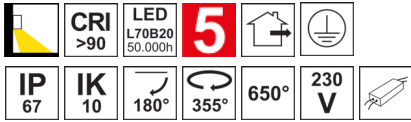

- Projecteur pour éclairage extérieur.
- Diffuseur en verre sérigraphié noir.
- Faisceau asymétrique.
- Livré avec 1.50m de câble (HO5RN-F 3x0.75mm²).
- Convertisseur non dimmable intégré dans l'appareil.

RAYPRO 50 A	COULEUR	MATIÈRE	P	CCT	LED LUMEN	SYSTEM LUMEN	€
PRO50/AS/3K/A	ANTHRACITE	FONTE D'ALUMINIUM	50W	3000K	5650Lm	4490Lm	297,00
PRO50/AS/3K/G	GRIS MAT	FONTE D'ALUMINIUM	50W	3000K	5650Lm	4490Lm	297,00
PRO50/AS/3K/W	BLANC MAT	FONTE D'ALUMINIUM	50W	3000K	5650Lm	4490Lm	297,00

ACCESSOIRES	COULEUR	MATIÈRE	DESCRIPTION	L(MM)	€
BASE/PRO/A	ANTHRACITE	ALUMINIUM	EQUERRE DE FIXATION POUR POTEAU DIAM. 60MM & 76MM		45
POLE/PRO/G	GRIS MAT	ALUMINIUM	TETE DE FIXATION POUR POTEAU DIAM. 60MM	118 / 103	80
BASE/PRO/W	BLANC MAT	ALUMINIUM	EQUERRE DE FIXATION POUR POTEAU DIAM. 60MM & 76MM	Ø68	45
POLE/PRO/A	ANTHRACITE	ALUMINIUM	TETE DE FIXATION POUR POTEAU DIAM. 60MM		80
BASE/PRO/G	GRIS MAT	ALUMINIUM	EQUERRE DE FIXATION POUR POTEAU DIAM. 60MM & 76MM	151	45
POLE/PRO/W	BLANC MAT	ALUMINIUM	TETE DE FIXATION POUR POTEAU DIAM. 60MM	44 / 28	80



ANTHRACITE

GRIS MAT

BLANC MAT



SPOTS

ADA 1 RX



- Spot encastré rond orientable.
- 2700K, 3000K ou 4000K au choix via un interrupteur à l'arrière du luminaire.
- Fixation par ressorts.
- Convertisseur non dimmable déporté fourni.

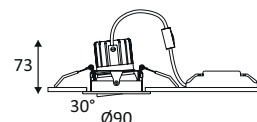

ADA 1 RX	COULEUR	MATIÈRE	P	CCT	LED LUMEN	SYSTEM LUMEN	α	€
OU49805	■ NOIR MAT	ALUMINIUM	9W	2700K 3000K 4000K	1100Lm (4000K)	775Lm (4000K)	38°	92,00
OU49830	□ BLANC MAT	ALUMINIUM	9W	2700K 3000K 4000K	1100Lm (4000K)	775Lm (4000K)	38°	92,00



NOIR MAT



BLANC MAT

ADA 2 RX



- Spot encastré rond orientable.
- 2700K, 3000K ou 4000K au choix via un interrupteur à l'arrière du luminaire.
- Fixation par ressorts.
- Convertisseur non dimmable déporté fourni.

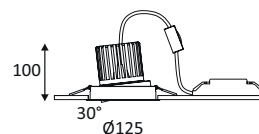

ADA 2 RX	COULEUR	MATIÈRE	P	CCT	LED LUMEN	SYSTEM LUMEN	α	€
OU49905	■ NOIR MAT	ALUMINIUM	18W	2700K 3000K 4000K	2225Lm (4000K)	1585Lm (4000K)	38°	138,00
OU49930	□ BLANC MAT	ALUMINIUM	18W	2700K 3000K 4000K	2225Lm (4000K)	1585Lm (4000K)	38°	138,00



NOIR MAT



BLANC MAT



ADA 1 RX



AL3012 RD OUT

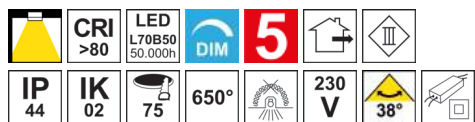

- Spot encastré rond fixe.
- Avec traitement de surface pour une meilleure résistance.
- Réflecteur basse luminance.
- Fixation par ressorts.
- Double bornier automatique.
- Convertisseur dimmable déporté fourni.
- Compatible avec variateur début et fin de phase.

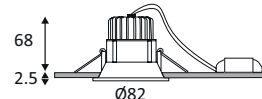

AL3012 RD OUT	COULEUR	MATIÈRE	P	CCT	LED LUMEN	SYSTEM LUMEN	α	€
OU328WW24	■ ANTHRACITE	FONTE D'ALUMINIUM	9W	3000K	940Lm	760Lm	38°	83,00
OU328WW30	■ BLANC MAT	FONTE D'ALUMINIUM	9W	3000K	940Lm	760Lm	38°	83,00



ANTHRACITE



BLANC MAT





H2 PRO EXTREME CSP



- Spot encastré rond fixe 3 en 1.
- 2200K, 2700K ou 3000K au choix via un interrupteur à l'arrière du luminaire.
- IP65 du dessus et du dessous.
- Avec protection contre la corrosion et le brouillard salin, convient aux zones côtières.
- Fixation par ressorts.
- Ne nécessite pas de convertisseur.
- Dimmable, compatible avec variateur début et fin de phase.

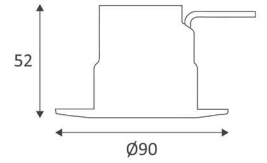

H2 PRO EXTREME CSP	COULEUR	MATIÈRE	P	CCT	LED LUMEN	SYSTEM LUMEN	α	€
H2EXT1B	NOIR MAT	ALUMINIUM + COMPOSITE	5W	2200K 2700K 3000K	600Lm (3000K)	560Lm (3000K)	40°	36,00
H2EXT1A	ANTHRACITE	ALUMINIUM + COMPOSITE	5W	2200K 2700K 3000K	600Lm (3000K)	560Lm (3000K)	40°	36,00
H2EXT1W	BLANC MAT	ALUMINIUM + COMPOSITE	5W	2200K 2700K 3000K	600Lm (3000K)	560Lm (3000K)	40°	36,00



NOIR MAT



ANTHRACITE



BLANC MAT



SOLAIRES

RAMA W

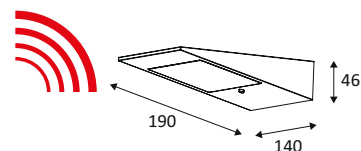
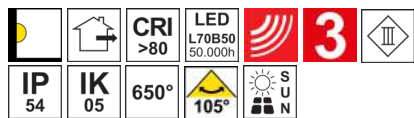

- Applique avec cellules solaires et batterie rechargeable.
- Fonctionne uniquement quand la luminosité est inférieure à 20 Lux.
- Avec interrupteur et détecteur HF 180°, distance de détection max. 6m.
- Deux niveaux d'éclairage après détection, 195 lumens pendant 30 secondes puis 30 lumens avec une autonomie de 15 heures.
- Temps de charge 6 à 8 heures en plein ensoleillement.

RAMA W	COULEUR	MATIÈRE	P	T°	LED LUMEN	SYSTEM LUMEN	α	€
OU464WW24	■ Anthracite	Fonte d'aluminium	2W	3000K	550lm	195lm	105°	164,00

RAMA P

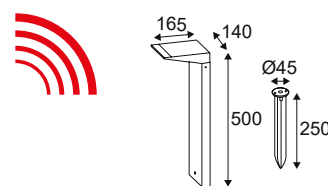
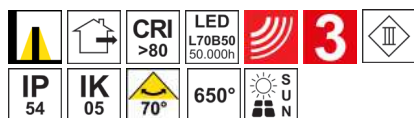

- Borne avec cellules solaires et batterie rechargeable.
- Fonctionne uniquement quand la luminosité est inférieure à 20 Lux.
- Avec interrupteur et détecteur HF 180°, distance de détection max. 6m.
- Deux niveaux d'éclairage après détection, 140 lumens pendant 30 secondes puis 20 lumens avec une autonomie de 15 heures.
- Temps de charge 6 à 8 heures en plein ensoleillement.
- Piquet à enterrer inclus.

RAMA P	COULEUR	MATIÈRE	P	T°	LED LUMEN	SYSTEM LUMEN	α	€
OU348WW24	■ Anthracite	Fonte d'aluminium	2W	3000K	550lm	140lm	70°	177,00
OU348NW24	■ Anthracite	Fonte d'aluminium	2W	4000K	600lm	140lm	70°	177,00





KALA



- Borne carrée avec cellules solaires et batterie rechargeable.
- Fonctionne uniquement quand la luminosité est inférieure à 20 Lux.
- Avec interrupteur et détecteur IR 120°, rayon de détection max. 6m.
- Deux niveaux d'éclairage après détection, 225 lumens pendant 45 secondes puis 35 lumens avec une autonomie de 15 heures.
- Temps de charge 6 à 8 heures en plein ensoleillement.
- Piquet à enterrer inclus.

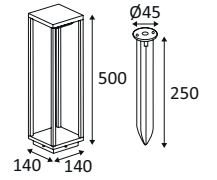

KALA	COULEUR	MATIÈRE	P	T°	L(MM)	LED LUMEN	SYSTEM LUMEN	€
OU342NW24	■ ANTHRACITE	FORTE D'ALUMINIUM	2W	4000K	140	600Lm	225Lm	206,00



ACCESSOIRES

SOURCES, DOUILLES ET CABLÉS	506
ALIMENTATIONS	510
GESTION D'ÉCLAIRAGE	516
BOÎTES DE RACCORDEMENT & CONNECTEURS	520

SOURCES, DOUILLES ET CÂBLES

SUP 08 AUTO



- Etrier avec douille GU10.
- Double bornier automatique.
- Ne nécessite aucun outil.

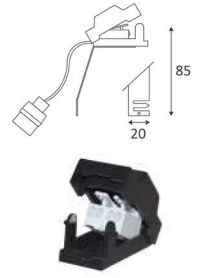

SUP 08 AUTO	DOUILLE	WATT MAX	€
SUP08	GU10	50W	5,00

LP520



- BORA 230 EVO SOURCE LED 3,8W 615Lm 60°.



LP520	LED LUMEN	LED	€
LP520	615Lm	3,8W	7,00

WCR275BLACK

- Câble en caoutchouc 2 fils.
- H05RN-F 2x0,75mm².
- Fourni au mètre.
- Limité à une utilisation en basse tension.
- Adapté à une utilisation en extérieur.









WCR275BLACK	L(MM)	€
WCR275BLACK	1000	8,00



ALIMENTATIONS









CONVERTISSEURS CC NON DIMMABLES

	CODE	WATT MAX	PRI	SEC	INPUTS	OUTPUTS	L(mm)	l(mm)	H(mm)	€	
2	 CD170	IP 20	5,5-7W	230V AC - 50HZ	DC 350mA	1	1	71	36	22	18,00
5	 CD155	IP 20	2-3W	230V AC - 50HZ	DC 350mA	1	1	86	32	23	26,00
5	 DRV150700	IP 20	6-30W	230V AC - 50HZ	DC 150-250-350-500-700mA	1	1	132	43	22	46,00
5	 PSIP3509W	IP 65	1-9W	230V AC - 50HZ	DC 350mA	1	1	149	37	24	49,00
5	 PSIP35018W	IP 65	9-18W	230V AC - 50HZ	DC 350mA	1	1	149	37	24	65,00
5	 PSIP70018W	IP 65	2-18W	230V AC - 50HZ	DC 700mA	1	1	149	37	24	65,00
5	 PSIP70036W	IP 65	18-36W	230V AC - 50HZ	DC 700mA	1	1	162	41	24	83,00





CONVERTISSEURS CC DIMMABLES COUPURE DE PHASE

	CODE	WATT MAX	PRI	SEC	INPUTS	OUTPUTS	L(mm)	l(mm)	H(mm)	€	
3	 CD147	IP 20	5-10W	230V AC - 50HZ	DC 700mA	1	1	95	53	25	34,00
5	 CD191	IP 20	20-28W	230V AC - 50HZ	DC 500/700mA	1	1	95	53	30	45,00
3	 CD102	IP 20	6,5-13,5W	230V AC - 50HZ	DC 350mA	1	1	95	53	25	47,00
3	 CD112	IP 20	9-18W	230V AC - 50HZ	DC 350mA	1	1	95	53	25	49,00
3	 CD104	IP 20	9-18W	230V AC - 50HZ	DC 500mA	1	1	95	53	30	50,00
5	 DRV350700TD	IP 20	14-20W	230V AC - 50HZ	DC 350-500-700mA	1	1	150	43	29	72,00































CONVERTISSEURS CC DIMMABLES COUPURE DE PHASE POUR BORA RD(X)-230 EVO

























































	CODE	WATT MAX	PRI	SEC	INPUTS	OUTPUTS	H(mm)	€	
3	 CD520 	IP 20	5W	230V AC - 50HZ	DC 145mA	1	1	23	10,00



CONVERTISSEURS CC DIMMABLES 0/1-10V - DALI - PUSH-DIM

	CODE	WATT MAX	PRI	SEC	INPUTS	OUTPUTS	L(mm)	l(mm)	H(mm)	€	
8	 CD148 IP 20	3-18W	230V AC - 50HZ	DC 700mA	1	1	150	42,5	22	70,00	
8	 CD116 IP 20	3-18W	230V AC - 50HZ	DC 500mA	1	1	150	42,5	22	79,00	
8	 CD126 IP 20	4-27W	230V AC - 50HZ	DC 500mA	1	1	150	42,5	22	79,00	
8	 CD123 IP 20	3-18W	230V AC - 50HZ	DC 250mA	1	1	150	42,5	22	80,00	
8	 CD140 IP 20	3-18W	230V AC - 50HZ	DC 350mA	1	1	150	42,5	22	90,00	
8	 CD124 IP 20	3-18W	230V AC - 50HZ	DC 300mA	1	1	150	42,5	22	92,00	
5	 PLDUNI-DRIVE700MA IP 20	3-27W	230V AC - 50HZ	DC 700mA	1	1	103	67	22	100,00	
5	 PLDUNI-DRIVE350MA IP 20	1-10W	230V AC - 50HZ	DC 350mA	1	1	103	67	22	110,00	
5	 PSDAL700M IP 20	3-50W	230V AC - 50HZ	DC 700mA	1	1	123	79	22	146,00	 
7	 PSDIM700 IP 20	3-50W	230V AC - 50HZ	DC 700mA	1	1	123	79	22	152,00	
8	 CD122 IP 20	9-55W	230V AC - 50HZ	DC 1050mA	1	1	103	67	22,5	156,00	
5	 PSDIM350 IP 20	1-18W	230V AC - 50HZ	DC 350mA	1	1	123	79	22	158,00	
5	 PSDAL350M IP 20	1-18W	230V AC - 50HZ	DC 350mA	1	1	123	79	22	176,00	 

CONVERTISSEURS CV NON DIMMABLES

	CODE	WATT MAX	PRI - SEC	INPUTS	OUTPUTS	L(mm)	l(mm)	H(mm)	€	
2	 CD171 	20W	230V AC - 12V CV	1	1	128	50	13	42,00	
3	 CD158 	60W	230V AC - 24V CV	1	1	100	78	37	52,00	
3	 CD150 	120W	230V AC - 24V CV	1	2	160	98	38	53,00	
5	 5988 	30W	230V AC - 24V DC	1	1	300	30	16	55,00	
5	 5678 	75W	230V AC - 50HZ	1	2	180	52	30	60,00	
3	 5742 	150W	230V AC - 48VDC	1	2	227	38	30	60,00	
5	 5677 	120W	230V AC - 24VDC	1	2	300	40	30	75,00	
3	 CD151 	200W	230V AC - 24V CV	1	2	199	98	42	76,00	
5	 CD187 	60W	230V AC - DC 24V	1	1	155,5	41,5	30	78,00	
5	 5989 	60W	230V AC - 24V DC	1	1	300	30	16	85,00	
5	 5783 	75W	230V AC - 24VDC	1	1	155	49	32	90,00	
2	 5993 	100W	230V AC - 48V DC	1	1	190	52	37	95,00	
3	 5744 	250W	230V AC - 48VDC	1	2	318	45	18	115,00	
5	 5796 	180W	230V AC - 24V DC	1	1	345	50	35	115,00	
5	 5784 	100W	230V AC - 24VDC	1	1	206	68,6	37	120,00	
5	 5672 	150W	230V AC - 24VDC	1	1	206	68,6	37	120,00	
5	 5675 	150W	230V AC - 24VDC	1	2	240	60	49	140,00	
5	 5996 	240W	230V AC - 48V DC	1	1	244	71	37,5	220,00	
5	 5947 	240W	230V AC - 24VDC	1	1	220	62,5	41,3	280,00	
5	 5997 	320W	230V AC - 48V DC	1	1	244	71	37,5	350,00	







CONVERTISSEURS CV DIMMABLE COUPURE DE PHASE

	CODE	IP	WATT MAX	PRI-SEC	INPUTS	OUTPUTS	L(mm)	l(mm)	H(mm)	€
3	 CD153	IP20	75W	230V AC - 24V DC	1	2	295	40	32	234,00



CONVERTISSEURS CV DIMMABLE 0/1-10V - DALI - PUSH-DIM

	CODE	IP	WATT MAX	PRI	INPUTS	OUTPUTS	L(mm)	l(mm)	H(mm)	€
3	 CD154 	IP20	200W	230V AC - 24V DC	1	2	310	60	45	278,00
5	 5802/T 	IP20	100W	230V AC - 50HZ	1	2	295	43	30	280,00

GESTION D'ÉCLAIRAGE

CD136



- Variateur tension constante à commander avec bouton poussoir ou télécommande.
- Convertisseur 24Vdc et télécommande à commander séparément.
- La télécommande permet de contrôler 4 zones séparément.
- Un variateur CD136 est nécessaire par zone à contrôler.

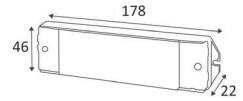

CD136	WATT MAX	PRI	SEC	INPUTS	OUTPUTS	L(MM)	l(mm)	H(mm)	€
CD136	4X120W	DC 24V	DC 24V	2	4	178	46	22	160,00
ACCESSOIRES		DESCRIPTION							€
CD14905	TELECOMMANDE RF							62,00	

CD135



- Contrôleur RGB 24Vdc livré avec télécommande.
- Fonctions ON/OFF, pause, «mode», vitesse et intensité.
- Portée de la télécommande 25m.
- Convertisseur 24Vdc à commander séparément.

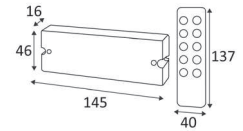

CD135	WATT MAX	PRI	SEC	INPUTS	L(MM)	l(mm)	H(mm)	€
CD13505	3X120W	DC 24V	DC 24V	2	145	46	16	92,00

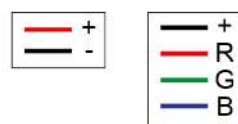
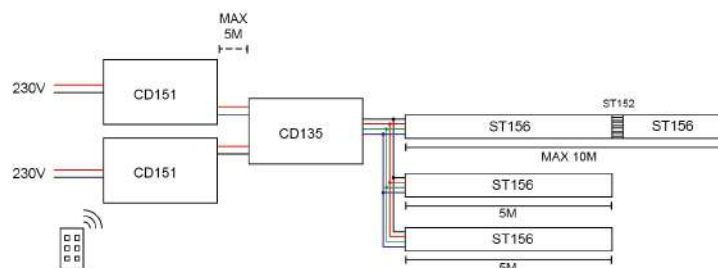
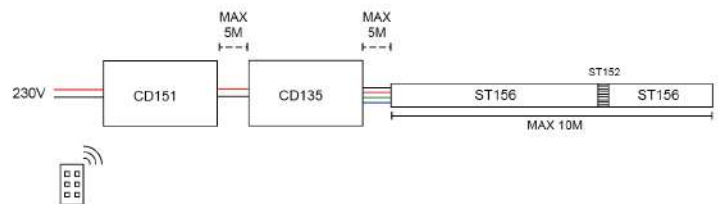

LEDEP10



- Kit d'éclairage de secours.
- Permet de convertir les luminaires compatibles en éclairage de secours.
- Test automatique (possibilité de test manuel via un bouton test fourni).
- Voyant bicolore rouge/vert indiquant le statut de l'installation.
- Autonomie minimale de 3 heures.
- Diamètre d'encastrement : 18mm (voyant LED), 7mm (bouton test).
- Connecteurs Plug & Play.
- Compatible avec les produits THEA, SOLIS et DOMINO.

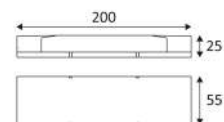

LEDEP10	WATT MAX	L(MM)	l(mm)	H(mm)	€
LEDEP10	2,5W	200	55	25	227,00

BOÎTES DE RACCORDEMENT ET CONNECTEUR IP

WC59

IP
68

- Connecteur rapide étanche.
- Immergeable jusqu'à 9m.
- Doté d'une entrée et d'une sortie.
- Diamètre du câble compatible : 5 à 9mm.
- Conducteur de max 4mm².
- Tension maximum : 250VAC / 50VDC.
- Courant maximum : 10A.
- Compatible avec le câble WCR275BLACK.



WC59	L(MM)	€
WC59	125	77,00

JB1

IP
68

- Boîte de raccordement étanche.
- Pour le montage en parallèle de produits en extérieur.
- Dotée d'une entrée et de trois sorties.
- Une sortie peut être raccordée à une autre boîte JB1.
- Diamètre du câble compatible : 5 à 6,5mm.
- Conducteur de max 1mm².
- Pour basse tension uniquement : max 30VDC.
- Courant maximum : 5A.

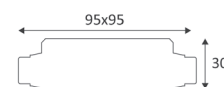

JB1	L(MM)	€
JB1	95	12,00

JB2

- Boîte de raccordement étanche.
- Pour le montage en série de produits en extérieur.
- Dotée d'une entrée et de trois sorties.
- Une sortie peut être raccordée à une autre boîte JB2.
- Diamètre du câble compatible : 5 à 6,5mm.
- Conducteur de max 1mm².
- Pour basse tension uniquement : max 48VDC.
- Courant maximum : 700mA.

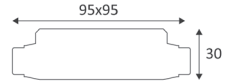

JB2	L(MM)	€
JB2	95	12,00

**JB4**

- Boîte de connexion étanche siliconée.
- Pour le montage en série de produits en extérieur.
- Dotée d'une entrée et de trois sorties.
- Diamètre du câble compatible : 6,5 à 12mm.
- Conducteur de max 1,5mm².
- Tension maximum : 120VDC.
- Courant maximum : 700mA.

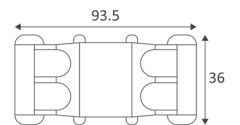

JB4	L(MM)	€
JB4	93,5	51,00



JB5

IP
68

- Boîte de connexion étanche siliconée.
- Pour le montage en parallèle de produits en extérieur.
- Dotée d'une entrée et de trois sorties.
- Diamètre du câble compatible : 6,5 à 12mm.
- Conducteur de max 1,5mm².
- Tension maximum : 250VAC.
- Courant maximum : 16A.

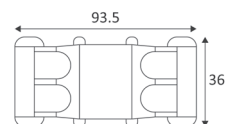

JB5	L(MM)	€
JB5	93,5	51,00

JB6

IP
68

- Connecteur étanche siliconé.
- Pour connexion filaire continue en extérieur.
- Doté d'une entrée et d'une sortie.
- Diamètre du câble compatible : 4,8 à 6mm.
- Conducteur de max 0,75mm².
- Tension maximum : 250VAC.
- Courant maximum : 6A.

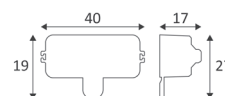

JB6	L(MM)	€
JB6	40	31,00

JB7

IP
68

- Connecteur étanche 5 bornes à visser.
- Pour le montage de produits RGBW uniquement, en extérieur.
- Doté d'une entrée et d'une sortie.
- Diamètre du câble compatible : 7 à 10,5mm.
- Conducteur de max 4mm².
- Tension maximum : 24V.
- Courant maximum : 1,4A.

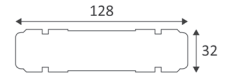

JB7	L(MM)	€
JB7	128	40,00



INDIGO

LIGHTING

PICTOGRAMMES

528

INDEX GÉNÉRAL

530

PICTOGRAMMES

	Usage intérieur.		
	Usage extérieur.		Le produit ne peut pas être recouvert après montage, même par un isolant.
	Usage intérieur et extérieur.		Le produit peut être recouvert après montage par un isolant déroulé.
	Montage au plafond en encastré uniquement.		Le produit peut être recouvert après montage par un isolant déroulé ou soufflé.
	Montage au plafond en encastré uniquement.	IP 20	Protection contre la pénétration de corps supérieurs à 12mm. Sans protection contre l'eau.
	Montage au plafond uniquement.	IP 23	Protection contre les pénétrations des corps solides supérieurs à 12mm. Protection contre les chutes verticales de gouttes d'eau avec angle d'inclinaison de max. 60°.
	Montage sur un mur ou un plafond.	IP 33	Protection contre les pénétrations des corps solides supérieurs à 2,5mm. Protection contre les chutes verticales de gouttes d'eau avec angle d'inclinaison de max. 60°.
	Montage en suspension.	IP 40	Protection contre la pénétration des corps solides supérieurs à 1mm. Sans protection contre l'eau.
	Montage en suspension.	IP 44	Protection contre la pénétration des corps solides supérieurs à 1mm. Protection contre les projections d'eau.
	Montage sur un mur en encastré uniquement.	IP 54	Protection contre les poussières et contre les projections d'eau.
	Montage sur un mur en encastré uniquement.	IP 55	Protection contre la poussière. Protection contre les jets d'eau.
	Montage sur un mur uniquement.	IP 56	Protection contre la poussière. Protection contre les jets d'eau.
	Montage sur un mur uniquement.	IP 65	Étanchéité aux poussières. Protection contre les jets d'eau.
	Montage sur un mur uniquement.	IP 66	Étanchéité aux poussières. Étanchéité aux jets d'eau puissants.
	Montage sur un mur uniquement.	IP 67	Étanche aux poussières. Étanche à l'immersion temporaire.
	Montage sur un mur uniquement.	IP 68	Totalement protégé contre les poussières. Protégé contre les effets prolongés de l'immersion sous pression à 2m.
	Montage sur un mur uniquement. Ce luminaire éclaire avec 2 zones d'éclairage.	IK 00	Pas de protection.
	Montage sur un mur uniquement. Ce luminaire éclaire avec 2 zones d'éclairage.	IK 01	Protection contre une énergie de choc de 0,15 Joule.
	Montage dans le sol en encastré uniquement.	IK 02	Protection contre une énergie de choc de 0,20 Joule.
	Montage dans le sol en encastré uniquement.	IK 03	Protection contre une énergie de choc de 0,35 Joule.
	Montage sur le sol en apparent uniquement.	IK 04	Protection contre une énergie de choc de 0,50 Joule.
	Montage sur le sol uniquement.	IK 05	Protection contre une énergie de choc de 0,70 Joule.
	Montage sur le sol uniquement.	IK 06	Protection contre une énergie de choc de 1 Joule.
	Montage sur le sol uniquement.	IK 07	Protection contre une énergie de choc de 2 Joules.
	Luminaire mobile.	IK 08	Protection contre une énergie de choc de 5 Joules.
	Produit à isolation principale qui comporte des dispositifs reliant l'ensemble de ses parties métalliques accessibles au conducteur de protection.	IK 09	Protection contre une énergie de choc de 10 Joules.
	Produit dont les parties accessibles sont séparées des parties actives par double isolation ou isolation renforcée.	IK 10	Protection contre une énergie de choc de 20 Joules.
	Produit alimenté sous une très basse tension de sécurité (T.B.T.S) qui n'excède pas 50V (valeur efficace en courant alternatif).	IK 11	Protection contre une énergie de choc de 50 Joules.
	Conforme à la réglementation thermique en vigueur (France).		Anti-vandale.

PICTOGRAMMES

	Inox 304. Nettoyer régulièrement avec un produit adapté pour éviter toute corrosion. Pas d'agent mordant ni de matériau abrasif.		Livré avec lampe(s).
	Inox 316. Nettoyer régulièrement avec un produit adapté pour éviter toute corrosion. Pas d'agent mordant ni de matériau abrasif.		Avec prise USB.
	Testé à 650°.		Batterie rechargeable via prise USB.
	Testé à 750°.		Avec détecteur de mouvement.
	Testé à 850°.		Avec cellules solaires.
	Indice de rendu des couleurs >70.		Dimmable, avec variateur intégré.
	Indice de rendu des couleurs >80.		Le produit est dimmable.
	Indice de rendu des couleurs >85.		Le produit est dimmable (0-10V).
	Indice de rendu des couleurs >90.		Le produit est dimmable (1-10V).
	Indice de rendu des couleurs >95.		Le produit est dimmable (entrée DALI).
	A connecter à un courant alternatif de 12V.		Le produit est dimmable (entrée DALI + push-dim).
	A connecter à un courant alternatif de 230V.		Température de couleur variable de 1800K à 3000K suivant l'intensité de dimming.
	A connecter à une alimentation Led en voltage constant de 12VDC.		Température de couleur variable de 2000K à 3000K suivant l'intensité de dimming.
	A connecter à une alimentation Led en voltage constant de 24VDC.		Température de couleur à sélectionner.
	A connecter à une alimentation Led en voltage constant de 48VDC.		Température de couleur à sélectionner.
	Luminaire équipé d'un module LED en 230V.		Température de couleur à sélectionner.
	Alimentation non incluse.		Température de couleur à sélectionner.
	Branchement en parallèle.		Température de couleur à sélectionner.
	Branchement en série.		Température de couleur à sélectionner.
	Avec prises 2P + T 16A max. 2x2000W.		Blanc dynamique (2700K-6000K).
	UGR inférieur à 19.		Changement de couleur RGB.
	Orientation verticale possible du luminaire pour un maximum de x°.		RGB + White.
	Orientation horizontale possible du luminaire pour un maximum de x°.		Durée de vie (maintien du flux lumineux L et taux de mortalité B).
	Percement rectangulaire pour l'insertion du luminaire. La longueur et la largeur à respecter sont citées dans la fiche technique et le manuel de montage (mm).		Garantie 2 ans.
	Diamètre de percement pour l'insertion du boîtier du luminaire (mm).		Garantie 3 ans.
	Hauteur de faux-plafond minimum pour y inclure le luminaire (mm).		Garantie 5 ans.
	Largeur de faisceau.		Garantie 7 ans.
	Faisceau ajustable.		Garantie 8 ans.

A

ABY 1 RD	82
ABY 2 RD	82
ABY 3 RD	83
ADA 1 RX	496
ADA 2 RX	496
AIN3KCL	212
AIN3KPL	240
AL1014	68
AL1014 RDX	68
AL1014 RX	68
AL1015 RX	69
AL1016 RX	115
AL2014 SDX	69
AL3012 RD	79
AL3012 RD OUT	498
AL3012 RD WARM	79
ALA1013	26
ALA1013 RX GU10 AUTO	26
ALA1013S	27
ALA1013 SX GU10 AUTO	27
ALBA R GU10	182
ALBA S GU10	182
ALEX RDX	62
ALLY 1 RDX	94
ALLY 2 RDX	94
ALLY 3 RDX	84
ALLY 4 RDX	84
ALMA R	450
ALMA S	450
ALTEA 1 GU10	430
ALTEA 2 GU10	430
ALTO 1 GU10	431
ALTO 2 GU10	431
AMONT	412
ANDY	397
APA RD-230	377
ARCOLE	443
ARTSY	427
ASPI 1 SENSOR PLUS	474
ASPI 2 SENSOR PLUS	475
AUREA 1 C	202
AUREA 2 C	203
AUREA 3 T	278
AUREA 3 TP	279
AUREA 3 W	158
AUREA 4 W	159
AUREA P	227
AVI 1	421
AVI 2	421

B

BALI R GU10	28
BARKO	438
BASIL 1 P	390
BASIL 2 P	390
BASIL 3 P	391
BENS P	416
BENS W	442
BIG APA RD-230	377
BIXBY	165
BO1360A15	432
BORA RD EVO	56
BORA RDH EVO	60
BORA RDX EVO	58
BORA SD EVO	57
BORA SDX EVO	59
BORU 1	317
BORU 2	317
BORU 3	318
BORU 4	318
BP1	460
BP1A	460
BP2	462
BP2A	462
BRAMA 1	389
BRAMA 2	389
BRAVA RD-230	42

BRAVA RDH-230	42
BRIKPRO 1	460
BRIKPRO 1 A	460
BRIKPRO 2	462
BRIKPRO 2 A	462
BU101	336
BU102	336
BU103	338
BU104	338
BU105	333
BU106	333
BU107	334
BU108	334
BU109	337

C

CAIMAN QUICK CONNECT	346
CAIMAN TUBULAR	345
CAIMAN VERSA	346
CAIQC	346
CAIV	346
CAPRI R 1 C	216
CAPRI R 1 P	244
CAPRI R 2 C	217
CAPRI R 2 P	244
CAPRI R 3 C	218
CAPRI R 3 P	245
CAPRI S 1 C	219
CAPRI S 1 P	246
CAPRI S 2 C	219
CAPRI S 2 P	246
CD102	512
CD102	512
CD104	512
CD112	512
CD116	513
CD122	513
CD123	513
CD124	513
CD126	513
CD135	518
CD135	518
CD136	518
CD136	518
CD140	513
CD147	512
CD148	513
CD150	514
CD151	514
CD153	515
CD154	515
CD155	512
CD158	514
CD170	512
CD171	514
CD175	514
CD176	514
CD178	514
CD186	514
CHERA	449
CL100	324
CL101	326
CL101	327
CL108	325
CL109	328
CL109	329
CLAC	207
CLAC 1 MINI	206
CLAC 2 MINI	206
CLIC RDX	96
CLIC RDX MINI	96
COMO RX GU10	29
COPE RD	72
COSTE 1	436
COSTE 2	436
CURTIS PLUS	482
CURTIS SENSOR PLUS	483
CYCLO	422

CYCLO SENSOR	422
--------------	-----

D

DALMA T	306
DANI	443
DAX RD-230	108
DEBI RD	44
DECO TRACK 48 L	300
DECO TRACK 48 M	298
DECO TRACK 48 S	302
DEVI	426
DIPLO 1	154
DIPLO 2	154
DISU 1	308
DISU 2	309
DM	136
DMCSP	137
DO102	114
DO103	40
DO104	40
DO107	115
DO108	69
DO160	68
DO164	70
DO165	70
DO171	79
DO182	69
DO221	80
DO224	96
DO225	207
DO241	35
DO246	92
DO263	210
DO315	45
DO330	79
DO334	34
DO337	36
DO344	125
DO346	126
DO365	96
DO366	88
DO430	44
DO431	44
DO444	90
DO459	38
DO460	38
DO461	82
DO462	82
DO464	83
DO465	72
DO466	72
DO467	39
DO468	34
DO487	108
DO488	124
DO489	126
DO490	92
DO491	90
DO495	88
DO500	85
DO501	78
DO513	28
DO514	28
DO515	91
DO518	29
DO527	94
DO528	94
DO529	84
DO530	84
DO531	122
DO532	122
DO533	62
DO536	108
DO538	118
DO539	119
DO540	120
DO541	121
DO542	100
DO543	100

D

DO544	42
DO545	42
DO546	24
DO547	24
DO549	64
DO550	64
DO551	56
DO552	58
DO553	60
DO554	57
DO555	59
DO560	104
DO561	104
DO564	76
DO565	55
DO566	54
DOMINO	136
DOMINO CSP	137
DOTS	85
DOTS C	222
DROPY P	238
DW110R	140
DW110S	140
DW1120R	195

E

EAZY	359
EDGY	447
ELBY S	435
ELENA L RDH	50
ELENA L RDX	51
ELENA M RDH	48
ELENA M RDX	49
ELENA S RDH	47
ELENA XL RDH	52
ELENA XL RDX	53
ELNE 1	408
ELNE 2	408
ELNE 4	408
EPI RD	72
EVA 62 R	195
EVA 65R	140
EVA 65S	140
EVIA G9	148

F

FARO 1	472
FARO 2	472
FIJI R GU10	28
FILI 1 RX-B	92
FILI 1 RX GU10 AUTO	90
FILI 5 RDX-B	92
FILI 5 RX-B GU10 AUTO	90
FILO P	419
FINN P	414
FL100	484
FL101	487
FL102	484
FL103	487
FLORIA 1	398
FLORIA 2	399
FLORIA 3	400
FLORIA 4	401
FOCAL	287
FOCEA 1 SX PLUS	126
FOCEA 2 SX	126
FOCUS	287
FOLD 1	167
FOLD 2	167
FOX 2 RD	114
FULLA	173
FURY S GU10	432

G

GENBAY 1	354
GENBAY 2	354
GENBAY 3	355
GL016 F II	373
GL016 II	372
GL016R	372
GL018 C	365
GL018C	365
GL019FD	367
GL019 F II	367
GL019 II	366
GL019LGF	368
GL019 LG II	368
GL019R	366
GL019UF	369
GL019 ULG II	369
GL038 II	376
GL038MF	376
GL040 II	374
GL040R	374
GL040UF	375
GL040 ULG II	375
GL100 II	382
GL100II	382
GL200	383
GL200	383
GLAM 90	174
GLAM 250	175
GLT1	379
GLT2	380
GLT3	380
GLT4	381
GLT5	381
GUNZY	394
GUNZY 2 P	396
GUNZY 2 S	441
GUNZY P	395
GUNZY S	441
GYRO	378
GYRO A	378

H

H2EXT	499
H2 PRO EXTREME CSP	499
HAPPY 1	198
HAPPY 2	199
HAPPY 3	200
HARRY A	457
HB100	356
HB101	356
HB102	357
HB108	359
HD1050	30
HD1050 R GU10	30
HD1070	30
HD1070 R GU5.3	30
HELLO 1 D	282
HELLO 1 P	239
HELLO 2 D	282
HELLO 2 P	239
HUBA P	240
HUGO GU10	432
HULA C	212
HULA P	241
HYB1	420
HYDRA	420

I

IENA RDX	44
INDY 1	484
INDY 1 A	484

INDY 2	487
INDY 2 A	487
INDY K3 CSP	488
INDY K3 CSP A	488
IPHO 82 RD	70
IPHO 82 SD	70
ITO	437
IZA 1 SDX	122
IZA 2 SDX	122

J

JACK 3 P	230
JACK 3 T	288
JACK 3 TP	290
JACK T	266
JACK TP	267
JB1	522
JB1	522
JB2	523
JB2	523
JB4	523
JB4	523
JB5	524
JB5	524
JB6	524
JB6	524
JB7	525
JB7	525
JUNE 1 C	214
JUNE 1 P	242
JUNE 2 C	214
JUNE 2 P	242
JUNE 3 C	215
JUNE 3 P	243
JUPI	150
JUPI S19	150

K

KACI R-B	37
KADRO E27	434
KAHA RDH	54
KAHA RDX	55
KALA	503
KALI R-230 B	36
KARL 1 RDX	100
KARL 2 RDX	100
KASA R GU10	24
KASA RX GU10	24
KAVA	172
KC211R	37
KO2000 R	364
KO2000 R GU10	364
KOPA	452
KORY R	64
KORY R SENSOR	64
KOS 1 S	454
KOS 2 R	454
KOS 2 S	455
KU1479	172
KUBO	453

L

LANTERN	447
LASY RX	34
LEDEP10	519
LEDEP10	519
LEWIS	468
LIDY	336
LIDY A	338
LIDY A SENSOR	338
LIDY SENSOR	336

L

LIDY SENSOR IR	337
LIKA	142
LIMA 1 PLUS	291
LIMA 2 PLUS	292
LIMA 3 PLUS	293
LINEA 1	294
LINEA 2	294
LINEAR 1 C	324
LINEAR 1 P	326
LINEAR 2 C	325
LINEAR 2 P	328
LISY RD	38
LISY RDX	38
LIVRO GU10	156
LONGA	177
LP520	508
LUPO 1 GU10	184
LUSY R	157
LUSY S	157
LUXI 45	444
LUXI 45 SENSOR	444
LUXI 54	410
LUXI 65 GU10	386
LUXI 80	418
LUXI 95	448
LUXI 100 S P	415
LUXI 120 S	446
LUXI 139	446
LUXI 175 SENSOR	445
LUXI 175 SENSOR P	411
LUXI 180	411
LUXI 190	448
LUXI 290	448
LUXI 650	412
LUZ 1	471
LUZ 2	471
LYON 1 R	118
LYON 2 R	119
LYON 3 R	120
LYON 4 R	121

M

MAKA	143
MALTA 1	176
MALTA 2	176
MANYL 2	185
MANYL 2 GU10	185
MARY RDX-230	45
MEKA	319
MILO 1	160
MILO 2	160
MILO 3	161
MILO 4	161
MINI TIMY E27	332
MINI TIMY EVO	333
MINI TIMY SENSOR E27	332
MINI TIMY SENSOR EVO	333
MINO P E27	406
MINO W E27	433
MODUS EVO 1	66
MODUS EVO 2	67
MOLY GU10	186
MOWI RD	39
MV0	66
MV1	67

N

NARIA 1 P	250
NARIA 2 P	251
NARIA 3 P	252
NOLY GU10	186

NORA	456
NOVA CSP 1 C	220
NOVA CSP 1 P	248
NOVA CSP 2 C	220
NOVA CSP 2 P	248
NOVA CSP 3 C	221
NOVA CSP 3 P	249
NV45	220
NV60	220
NV90	221

O

OBIA 1 C	196
OBIA 1 P	234
OBIA 1 RX	102
OBIA 2 C	196
OBIA 2 P	234
OBIA 2 RX	102
OLA 1	388
OLA 2	415
OLYN 1 P	228
OLYN 1 RDX	98
OLYN 1 W	168
OLYN 2 C	204
OLYN 2 P	229
OLYN 2 RDX	99
OLYN 3 T	280
ORKI	341
ORKI SENSOR	341
OSIS 1 PLUS	285
OSIS 2 PLUS	285
OU105	448
OU106	448
OU108	386
OU135	446
OU136	410
OU138	412
OU144	448
OU150	443
OU177	419
OU185	441
OU186	441
OU187	395
OU190	426
OU206	444
OU253	434
OU310	432
OU318	411
OU323	445
OU324	418
OU326	377
OU328	498
OU334	453
OU336	416
OU340	437
OU342	503
OU344	447
OU345	389
OU346	389
OU350	426
OU353	413
OU354	410
OU356	415
OU357	412
OU359	444

OU360	442
OU361	416
OU363	449
OU365	435
OU367	411
OU374	427
OU375	443
OU387	450
OU390	422
OU391	422
OU397	341
OU400	406
OU407	433
OU411	377
OU413	407
OU414	407
OU415	421
OU417	341
OU424	468
OU425	378
OU426	378
OU431	450
OU433	406
OU434	433
OU436	387
OU438	452
OU440	474
OU441	475
OU445	332
OU446	332
OU447	472
OU448	472
OU450	408
OU451	408
OU452	408
OU457	396
OU458	394
OU459	469
OU460	469
OU463	421
OU465	397
OU467	447
OU470	482
OU474	483
OU477	454
OU478	455
OU479	454
OU481	415
OU482	388
OU486	370
OU488	371
OU489	471
OU490	471
OU492	456
OU495	463
OU497	397
OU498	496
OU499	496
OU501	457
OU503	414
OU504	466
OU505	466
OU508	431
OU509	431
OU510	430
OU511	430
OU513	436
OU514	436
OU517	390
OU518	390
OU519	391

P

P2A	130
P2B	132
P2C	133
PIXA 1	208
PIXA 2	208

P

PIXA 3 209
 PK1 179
 PK2 179
 PLANK 1 179
 PLANK 2 179
 PLDUNIDRIVE350MA 513
 PLDUNIDRIVE700MA 513
 POL3 344
 POLAS VERSA 344
 POLO 463
 PRO14 489
 PRO32 490
 PRO32A 491
 PRO50 492
 PRO50A 493
 PSDAL350M 513
 PSDAL700M 513
 PSDIM350 513
 PSDIM700 513
 PSIP3509W 512
 PSIP35018W 512
 PSIP70018W 512
 PSIP70036W 512
 PT05M 440
 PT051A 439
 PT052A 440
 PT09001 392
 PT09002 393
 PURE 190 426

R

RAITO 1 316
 RAITO 2 316
 RAMA P 502
 RAMA W 502
 RAVEL 410
 RAY 268
 RAYPRO 14 489
 RAYPRO 32 490
 RAYPRO 32 A 491
 RAYPRO 50 492
 RAYPRO 50 A 493
 RETI 1 RX 104
 RETI 2 RX 104
 RETI P 236
 RETI W 170
 RIVA 2 GU10 193
 RIVA 3 GU10 193
 RIVA 4 GU10 194
 ROMY R GU10 466
 ROMY S GU10 466
 RONDO P E27 406
 RONDO W E27 433
 RONDY 1 P 232
 RONDY 1 W 152
 RONDY 2 P 232
 RONDY 2 W 152
 RUBYX R 458
 RUBYX S 458

S

SAMY RD 75
 SANDO T 305
 SANDO TP 305
 SENSO R-230 108
 SETO 416
 SILK RDX 78
 SIRA R 88
 SIRA R SENSOR IR 88
 SL040A 388
 SL040A 388

SL220 MAINS II 402
 SL220MII 402
 SL230M 403
 SL230 MAINS 403
 SLIM 417
 SM 417
 SNOOP 149
 SNOOP GU10 149
 SOLIP 131
 SOLIS 1 130
 SOLIS 2 132
 SOLIS 3 133
 SOLIS IP65 131
 SOLIS LENS 135
 SOLYA 162
 SPBM 144
 SPIRA 1 RX PLUS 124
 SPIRA 3 RX 125
 SPOTI R-B 35
 SPOTTY 1 P 392
 SPOTTY 1 W 439
 SPOTTY 2 P 393
 SPOTTY 2 W 440
 SPOTTY 3 W 440
 SPRINGBOK LITE 1 356
 SPRINGBOK LITE 2 356
 SPRINGBOK LITE 3 357
 STELLA 413
 STEPBEAM 144
 SU153 244
 SU154 244
 SU155 245
 SU156 242
 SU157 242
 SU158 254
 SU159 254
 SU160 226
 SU161 230
 SU163 243
 SU164 246
 SU165 246
 SU166 239
 SU167 239
 SU169 227
 SU170 248
 SU171 248
 SU172 249
 SU173 236
 SU174 241
 SU175 232
 SU176 232
 SU177 238
 SUP08 508
 SUP08 508
 SUP 08 AUTO 508
 SWEET RD EVO 76
 SWIM 370
 SYLA RD-B 80

T

TED 286
 THEA LITE CSP 1 112
 THEA LITE CSP 2 113
 THEA LITE CSP 3 113
 THEA PRO 1 116
 THEA PRO 2 117
 THL1 112
 THL2 113
 THL3 113
 THP1 116
 THP2 117
 TIBLI R-B 34
 TIGA 1 RD EVO 110
 TIGA 2 RD EVO 110
 TIGA 3 RD EVO 111
 TILT 1 379
 TILT 2 380
 TILT 3 380

TILT 4 381
 TILT 5 381
 TIMY EVO 334
 TIMY SENSOR EVO 334
 TIPI RX 40
 TIPI SX 40
 TIPO 1 C 210
 TIPO 2 C 210
 TOMA 315
 TOMO 315
 TOMY 1 C 223
 TOMY 1 P 254
 TOMY 2 P 254
 TONKA 307
 TORO T 304
 TORO TP 304
 TR220 272
 TR357 294
 TR358 294
 TR359 274
 TR389 282
 TR390 282
 TR393 287
 TR395 291
 TR397 292
 TR399 293
 TR401 260
 TR418 268
 TR419 264
 TR420 264
 TR422 276
 TR423 277
 TR424 288
 TR426 290
 TR428 266
 TR429 267
 TR431 262
 TR432 262
 TR433 278
 TR434 279
 TR435 286
 TR437 287
 TR438 285
 TR439 285
 TR445 316
 TR446 316
 TR447 317
 TR448 317
 TR449 318
 TR450 318
 TR451 319
 TR452 308
 TR453 309
 TR454 315
 TR455 315
 TR456 305
 TR457 305
 TR458 306
 TR459 311
 TR460 312
 TR461 313
 TR462 314
 TR463 311
 TR464 312
 TR465 313
 TR466 314
 TR467 310
 TR468 307
 TR469 304
 TR470 304
 TR471 298
 TR474 302
 TR474 303
 TR477 300
 TRACK III SURFACE 272
 TRACK III SURFACE 273
 TRACK UNO 260
 TRACK UNO 261
 TULO E27 407
 TULO SENSOR E27 407
 TURA GU10 387

U

UNIS R 469
 UNIS S 469

V

VITEL GX53..... 148

W

WA112 160
 WA128 165
 WA129 176
 WA132 208
 WA133 208
 WA134 209
 WA164 176
 WA165 160
 WA169 173
 WA173 142
 WA174 143
 WA175 174
 WA176 175
 WA179 210
 WA180 177
 WA182 206
 WA183 206
 WA194 186
 WA195 182
 WA196 182
 WA197 186
 WA198 187
 WA199 193

WA200 193
 WA201 194
 WA202 185
 WA203 184
 WA210 185
 WA215 161
 WA216 216
 WA217 217
 WA218 218
 WA222 214
 WA223 214
 WA224 223
 WA229 188
 WA230 189
 WA231 190
 WA232 191
 WA233 192
 WA234 164
 WA235 161
 WA236 167
 WA237 167
 WA238 198
 WA239 199
 WA240 200
 WA241 215
 WA242 219
 WA243 219
 WA248 222
 WA253 148
 WA254 148
 WA256 202
 WA257 203
 WA260 158
 WA261 149
 WA262 149
 WA263 159
 WA264 170
 WA265 150
 WA270 150
 WA274 156

WA275 154
 WA276 154
 WA277 157
 WA278 157
 WA279 152
 WA280 152
 WALLY A 371
 WC59 522
 WC59 522
 WCR275BLACK 509
 WCR275BLACK 509
 WL94 340
 WL94 340

Y

YERA 1 T GU10..... 262
 YERA 1 TP GU10 262
 YERA GU10..... 274
 YOKA 1 311
 YOKA 2 312
 YOKA 3 313
 YOKA 4 314
 YOKO 1..... 311
 YOKO 2..... 312
 YOKO 3..... 313
 YOKO 4..... 314
 YUKA 397
 YUKO GU10 187

Z

ZUMU..... 310



INDIGO
LIGHTING

Parc Artisanal de Cornemont
Rue de la Légende 32G
4141 Sprimont, Belgique

 +32 (0) 4 351 91 40

 info@indigo-lighting.com

 indigo-lighting.com

Publié en décembre 2025



INDIGO
LIGHTING

Parc Artisanal de Cornemont
Rue de la Légende 32G
4141 Sprimont, Belgique

 +32 (0) 4 351 91 40

 info@indigo-lighting.com

 indigo-lighting.com

Publié en décembre 2025



CAT FR 2026

